



US00D582957S

(12) **United States Design Patent**  
**Moritz**

(10) **Patent No.:** **US D582,957 S**

(45) **Date of Patent:** **\*\* Dec. 16, 2008**

(54) **EYEGLASS**

D545,345 S 6/2007 Moritz et al.  
D548,767 S 8/2007 Jannard et al.  
D553,173 S 10/2007 Baden et al.

(75) Inventor: **Hans Karsten Moritz**, Foothill Ranch,  
CA (US)

(73) Assignee: **Oakley, Inc.**, Foothill Ranch, CA (US)

(\*\*) Term: **14 Years**

(21) Appl. No.: **29/294,103**

(22) Filed: **Dec. 20, 2007**

(51) **LOC (8) Cl.** ..... **16-06**

(52) **U.S. Cl.** ..... **D16/309**

(58) **Field of Classification Search** ..... D16/101,  
D16/300-342; D29/109-110; D24/110.2;  
351/41, 44, 51-52, 62, 158, 92, 103-123,  
351/140, 153; 2/426-432, 447-449, 441,  
2/436, 434-437; D21/483, 659-661

See application file for complete search history.

(56) **References Cited**

**U.S. PATENT DOCUMENTS**

D187,299 S	2/1960	Behr	
D192,885 S	5/1962	Petitto	
D193,028 S	6/1962	Petitto	
D204,812 S	5/1966	Shindler	
4,904,078 A *	2/1990	Gorike	..... 351/158
D372,726 S	8/1996	Simioni	
D384,686 S	10/1997	Jannard et al.	
D390,589 S	2/1998	Simioni	
D425,103 S	5/2000	Yee et al.	
D426,258 S	6/2000	Jannard et al.	
D513,275 S	12/2005	Yee	
D514,613 S	2/2006	Jannard et al.	
D523,461 S	6/2006	Jannard et al.	

**OTHER PUBLICATIONS**

Spy Optics, Inc., "Cooper," "Oasis," "Clash," "MC," "Clint," and "Hourglass" models printed from www.spyoptic.com on May 26, 2006.

U.S. Appl. No. 29/285,424, filed Mar. 29, 2007.

U.S. Appl. No. 29/288,586, filed Jun. 15, 2007.

\* cited by examiner

*Primary Examiner*—Raphael Barkai

(74) *Attorney, Agent, or Firm*—Gregory K. Nelson

(57) **CLAIM**

The ornamental design for an eyeglass, as shown and described.

**DESCRIPTION**

FIG. 1 is a front perspective view of the eyeglass of the present invention;

FIG. 2 is a front elevational view thereof;

FIG. 3 is a rear elevational view thereof;

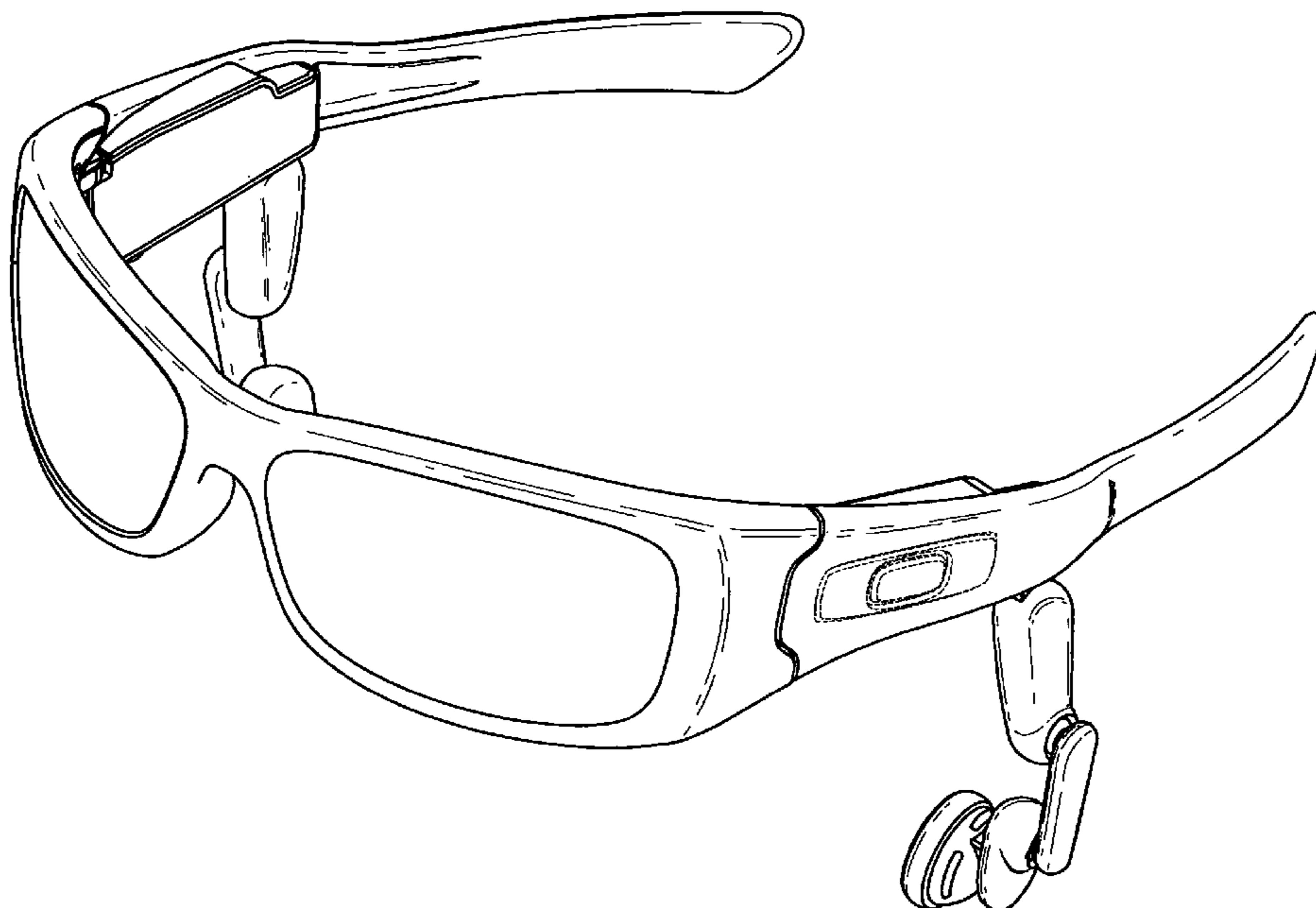
FIG. 4 is a left-side elevational view thereof, the right-side elevational view being a mirror image thereof;

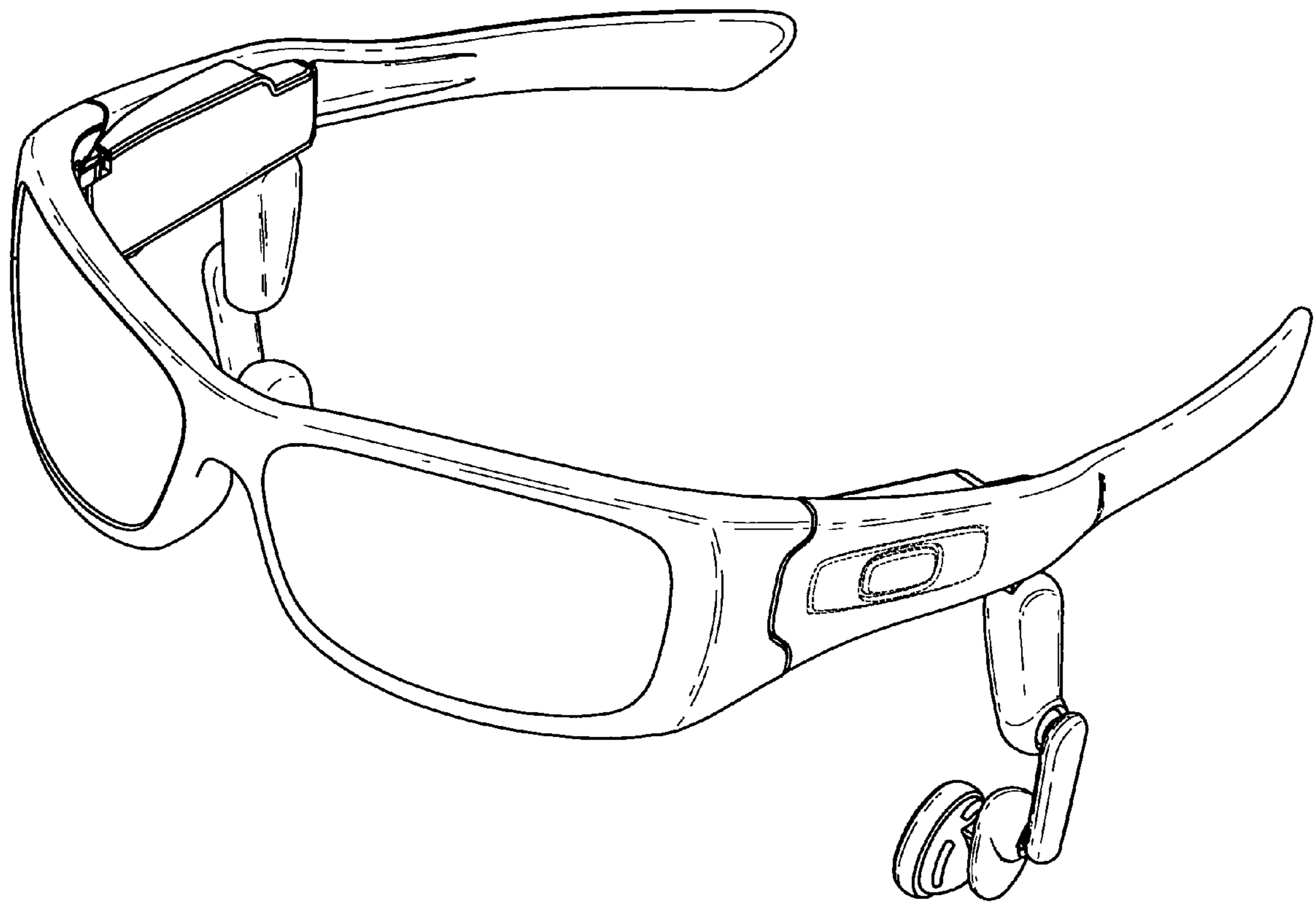
FIG. 5 is a top plan view thereof; and,

FIG. 6 is a bottom plan view thereof.

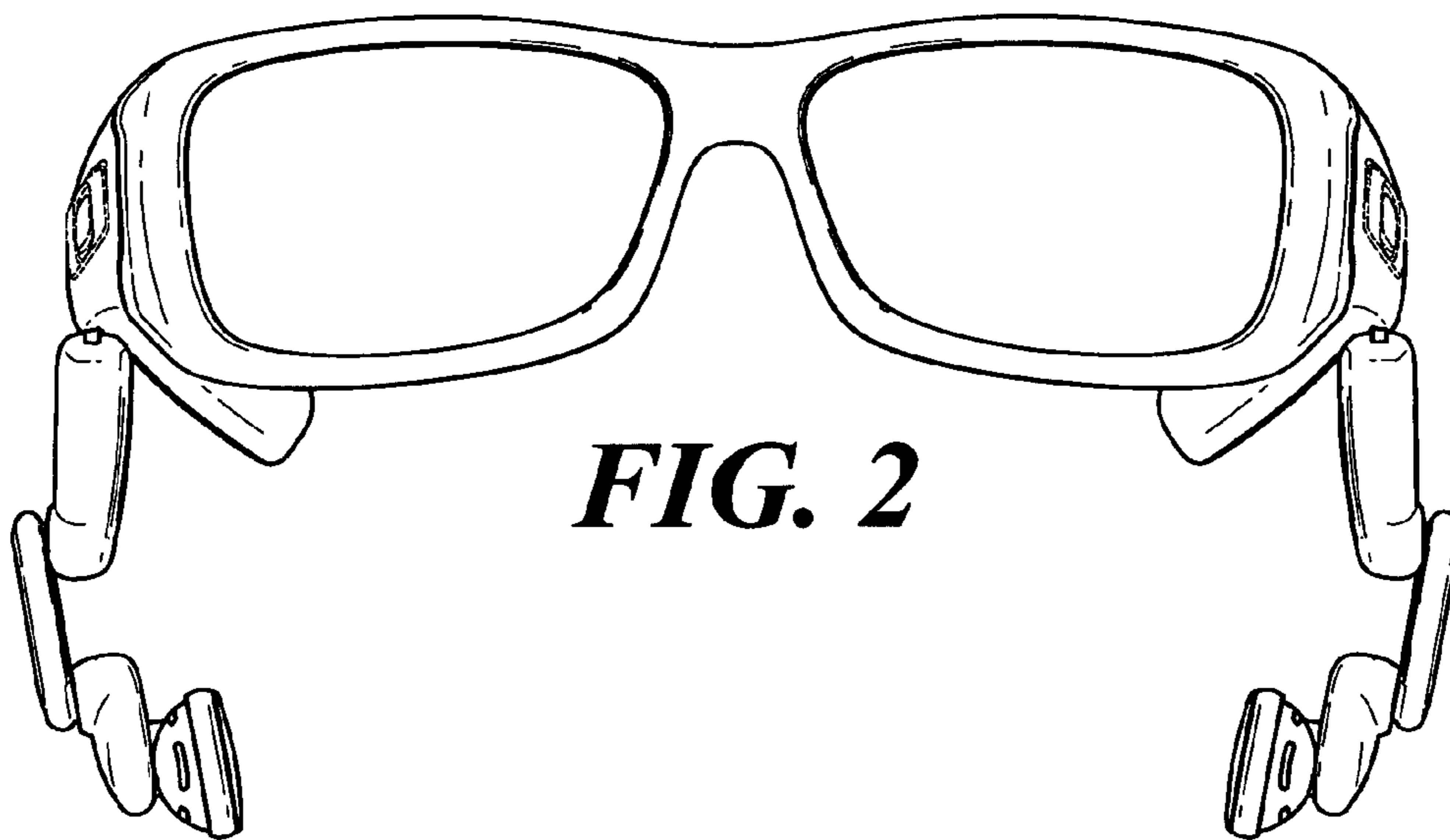
Phantom lining, where utilized, is for illustrative purposes only and is not intended to limit the claimed design to the features shown in phantom.

**1 Claim, 4 Drawing Sheets**

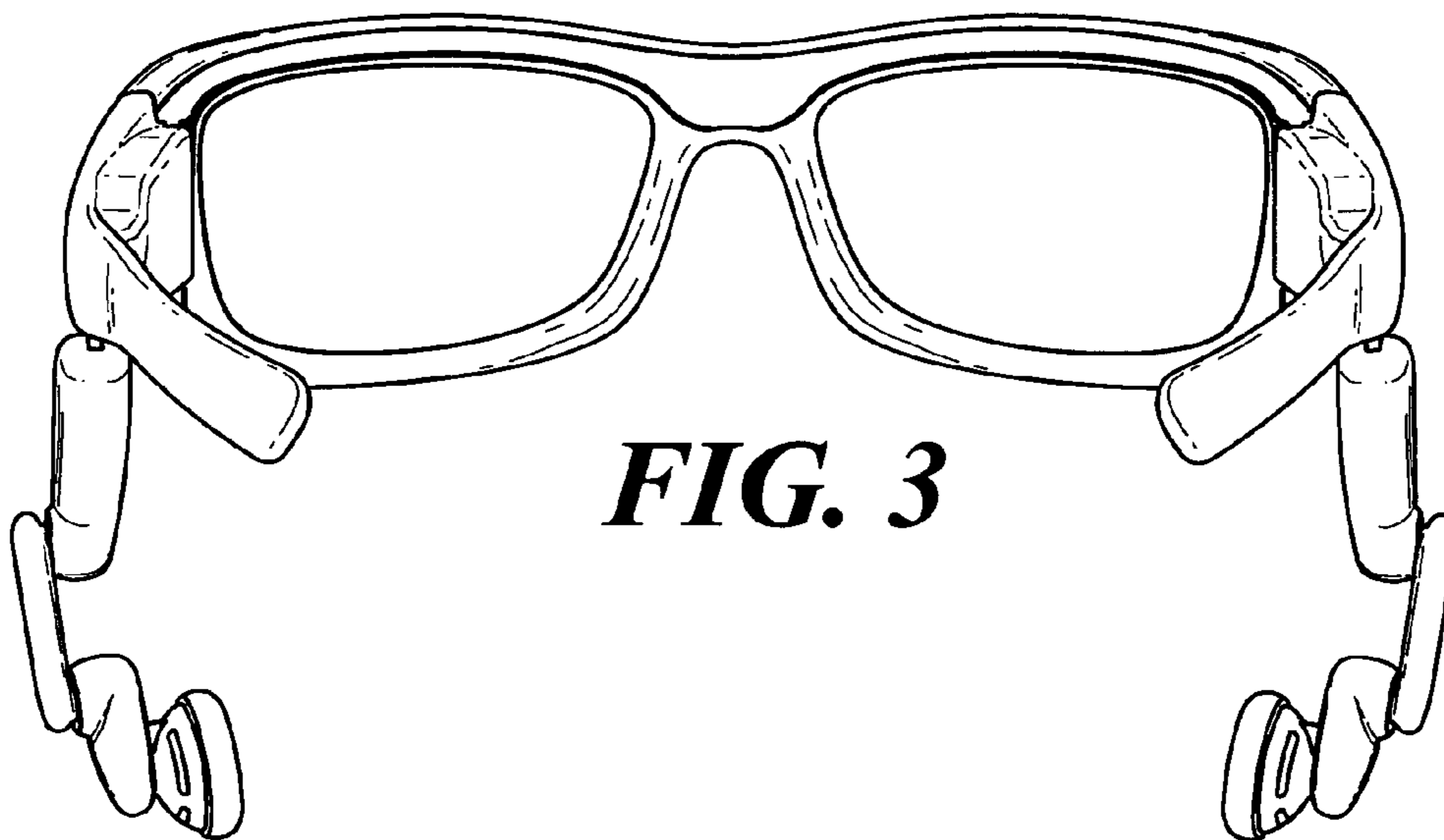




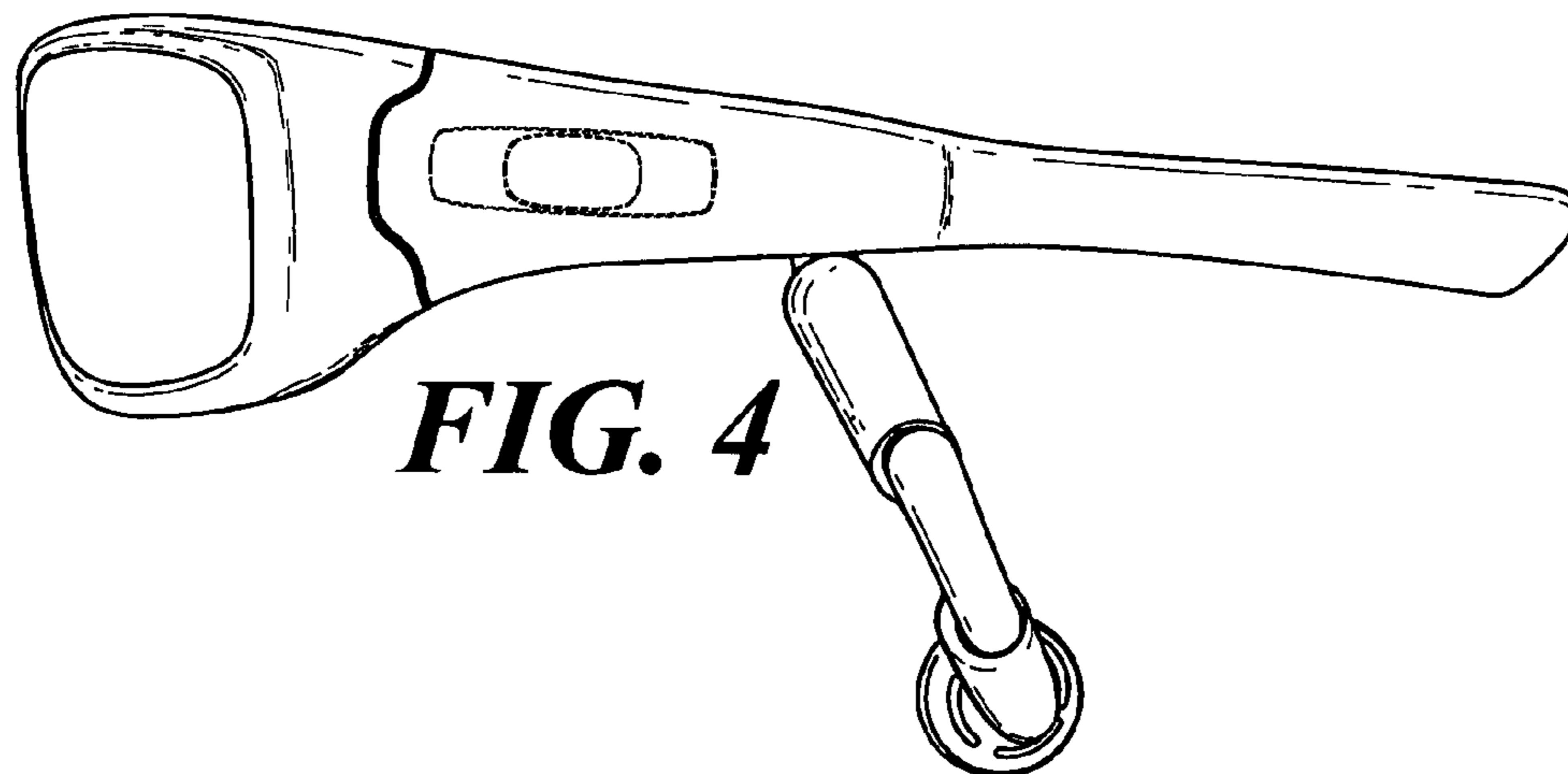
**FIG. 1**



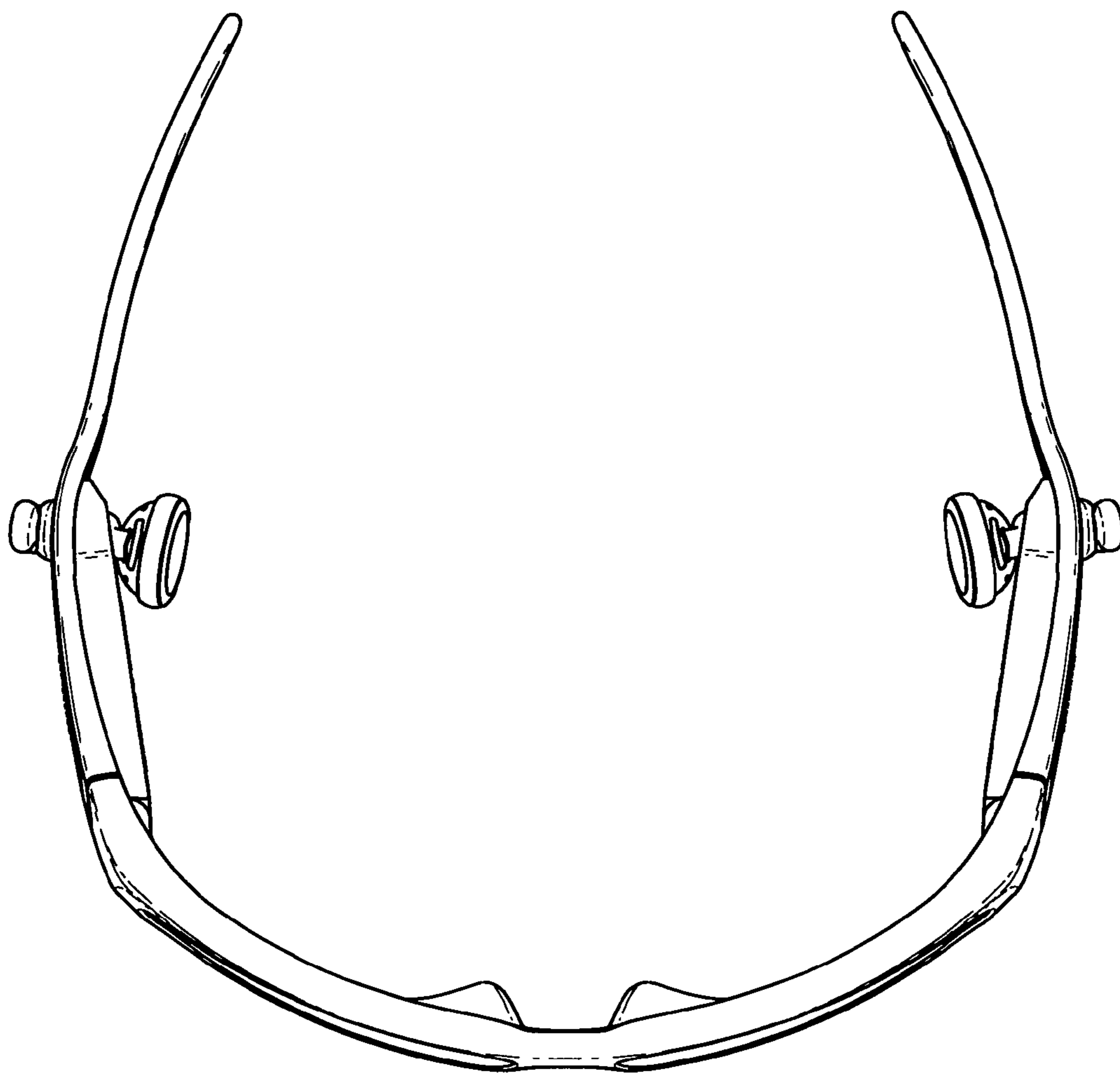
**FIG. 2**



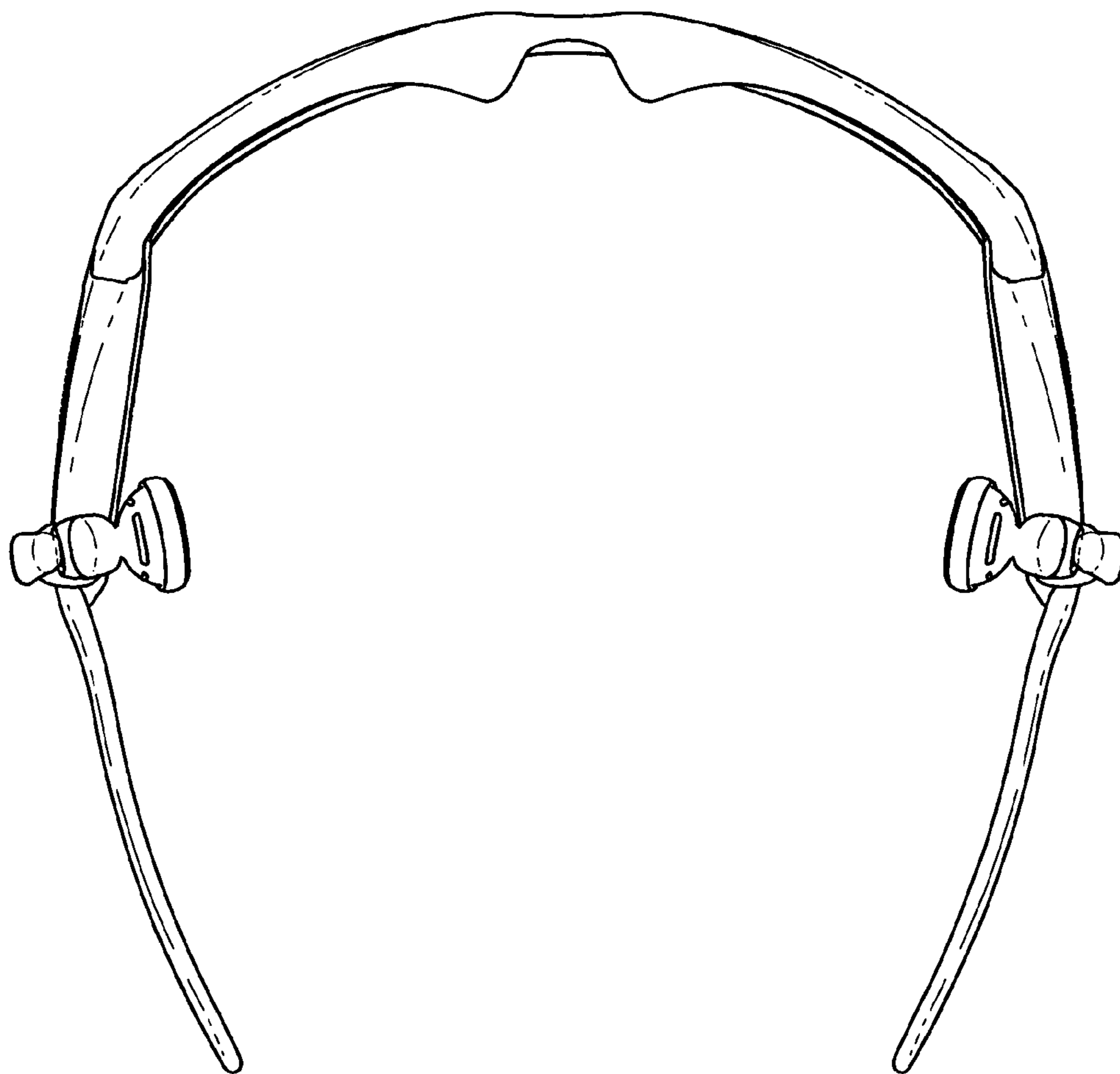
**FIG. 3**



**FIG. 4**



***FIG. 5***



***FIG. 6***