



US00D582807S

(12) **United States Design Patent**
Ichikawa et al.

(10) **Patent No.:** **US D582,807 S**

(45) **Date of Patent:** **** Dec. 16, 2008**

(54) **VEHICLE NAVIGATION UNIT WITH
DIGITAL VIDEO PLAYER**

(75) Inventors: **Takashi Ichikawa**, Tokyo (JP); **Hideki
Endo**, Yokohama (JP); **Hiroshi
Fukimoto**, Yachiyo (JP)

(73) Assignee: **Alpine Electronics, Inc.**, Tokyo (JP)

(**) Term: **14 Years**

(21) Appl. No.: **29/307,886**

(22) Filed: **May 19, 2008**

(30) **Foreign Application Priority Data**

Nov. 20, 2007 (JP) 2007-031847

(51) **LOC (8) Cl.** **10-04**

(52) **U.S. Cl.** **D10/65; D14/136**

(58) **Field of Classification Search** D10/65,
D10/70; D14/347, 125-134, 239, 371, 136,
D14/374-377, 440, 450, 448, 336, 342; 342/351,
342/419, 457, 357.06-357.16; 343/702;
345/87, 104, 133, 156, 168, 173, 901-905;
348/180, 184, 315, 739, 836, 838, 325; 364/444,
364/499; 701/206-209, 213-214; 312/7.2;
341/12; 720/605, 669, 600, 655; 369/99,
369/197; 455/344, 347

See application file for complete search history.

(56) **References Cited**

U.S. PATENT DOCUMENTS

D410,462 S * 6/1999 Sakagami D14/156
D421,007 S * 2/2000 Nagai D14/156
D487,024 S * 2/2004 Hsu Li D10/65
D507,193 S * 7/2005 Owaki et al. D10/65
7,137,676 B2 * 11/2006 Sugimoto et al. 312/7.2
D541,681 S * 5/2007 Sekino et al. D10/65

D543,474 S * 5/2007 Edmonds D10/65
D550,637 S 9/2007 Iwamoto et al.
D559,228 S * 1/2008 Iwamoto D14/157
D565,979 S 4/2008 Ichikawa et al.
D568,185 S * 5/2008 Sakai et al. D10/65
D572,219 S * 7/2008 Shimizu D14/136
D574,796 S * 8/2008 Yokoyama D14/132

OTHER PUBLICATIONS

U.S. Appl. No. 29/261,781, filed Jun. 20, 2006, Taro Iwamoto.
U.S. Appl. No. 29/261,821, filed Jun. 20, 2006, Taro Iwamoto.

* cited by examiner

Primary Examiner—Antoine D Davis

(74) *Attorney, Agent, or Firm*—Brinks Hofer Gilson & Lione

(57) **CLAIM**

We claim the ornamental design for a vehicle navigation unit with digital video player, as shown and described.

DESCRIPTION

FIG. 1 is a perspective view of a vehicle navigation unit with digital video player, showing our new, original and ornamental design;

FIG. 2 is a front elevational view thereof;

FIG. 3 is a rear elevational view thereof;

FIG. 4 is a left side elevational view thereof;

FIG. 5 is a right side elevational view thereof;

FIG. 6 is a top plan view thereof;

FIG. 7 is a bottom plan view thereof;

FIG. 8 is a front elevational view thereof, with the power on; and,

FIG. 9 is a perspective view thereof, with the face plate tilted downward.

1 Claim, 6 Drawing Sheets

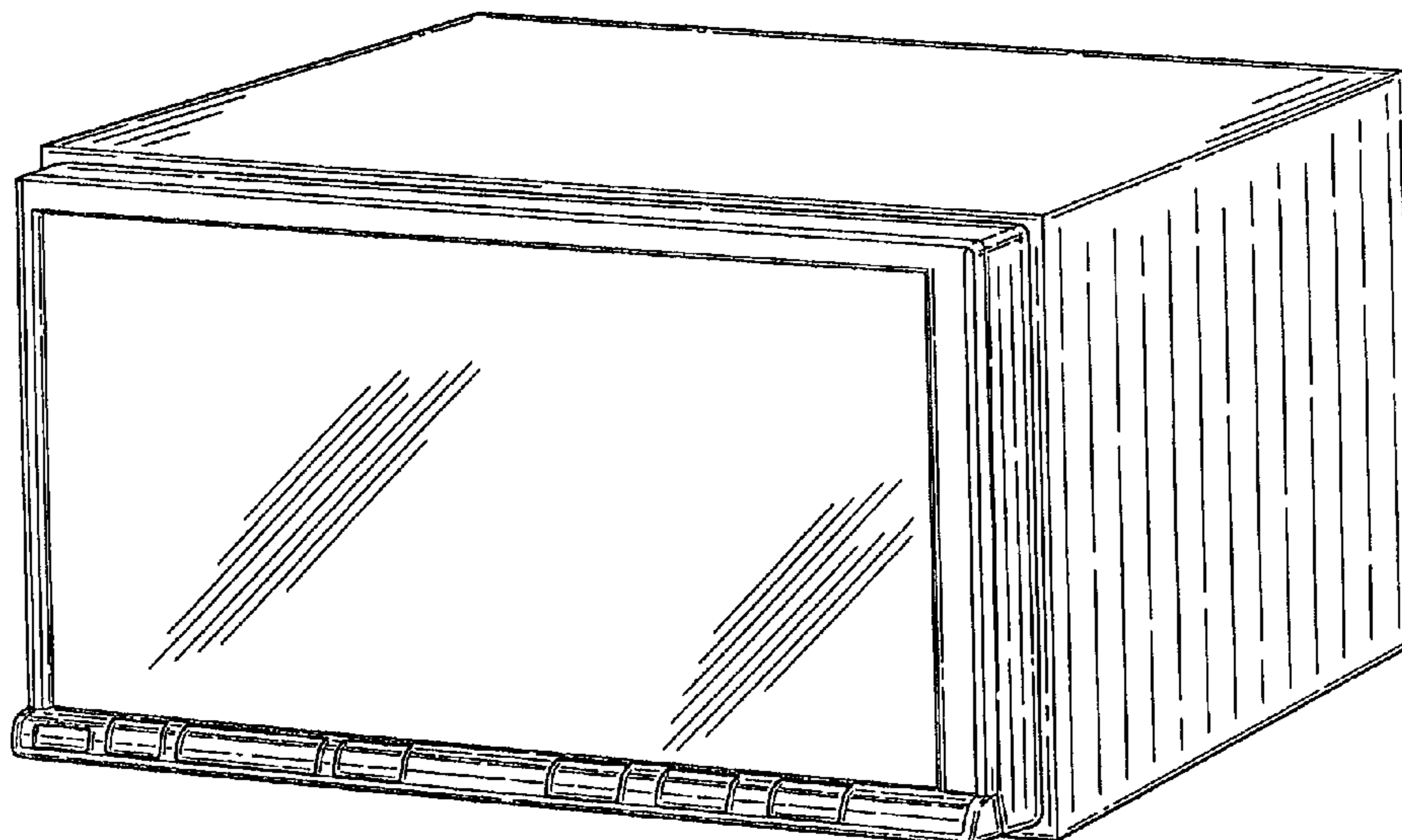

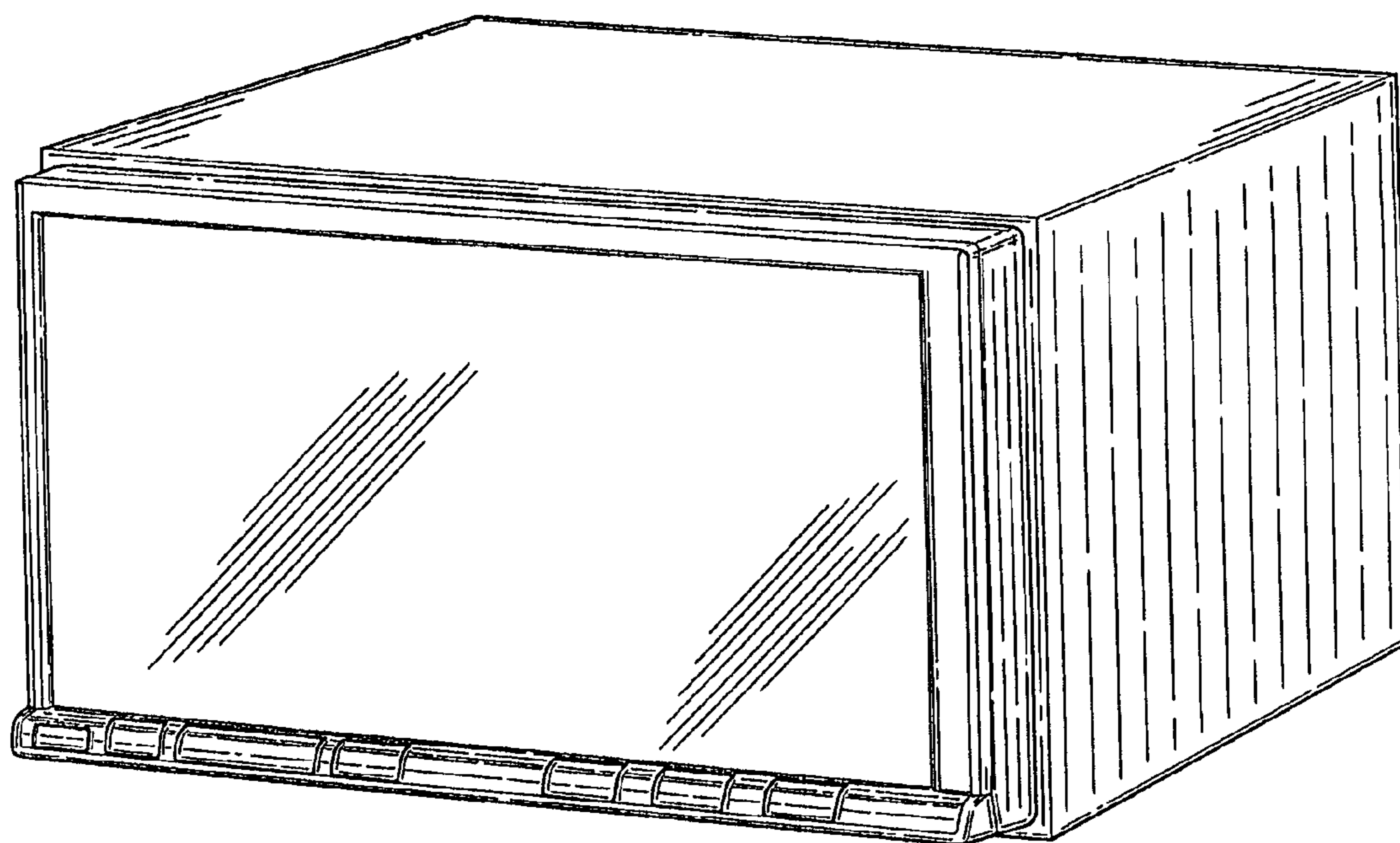

Fig. 1

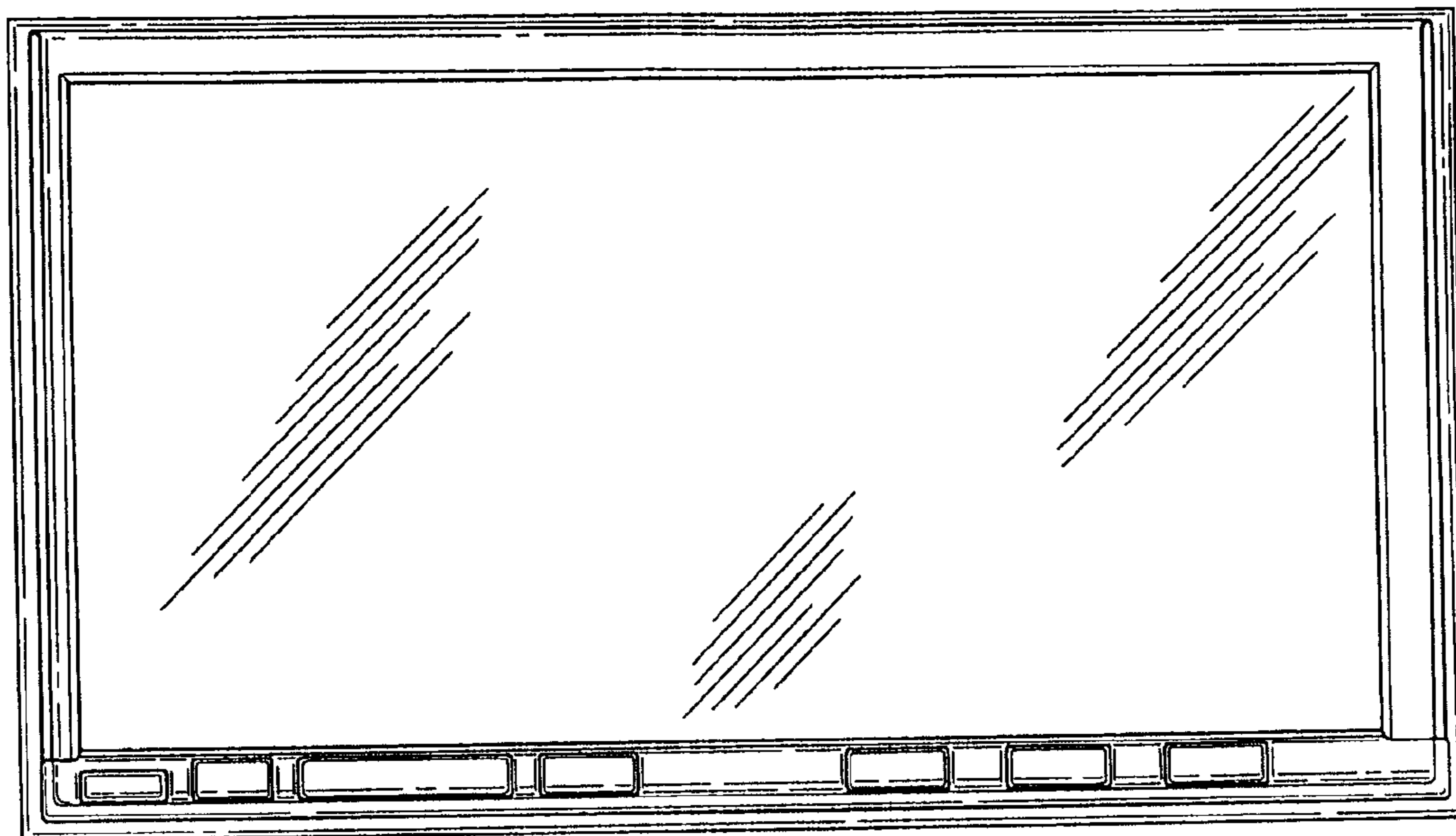

Fig. 2

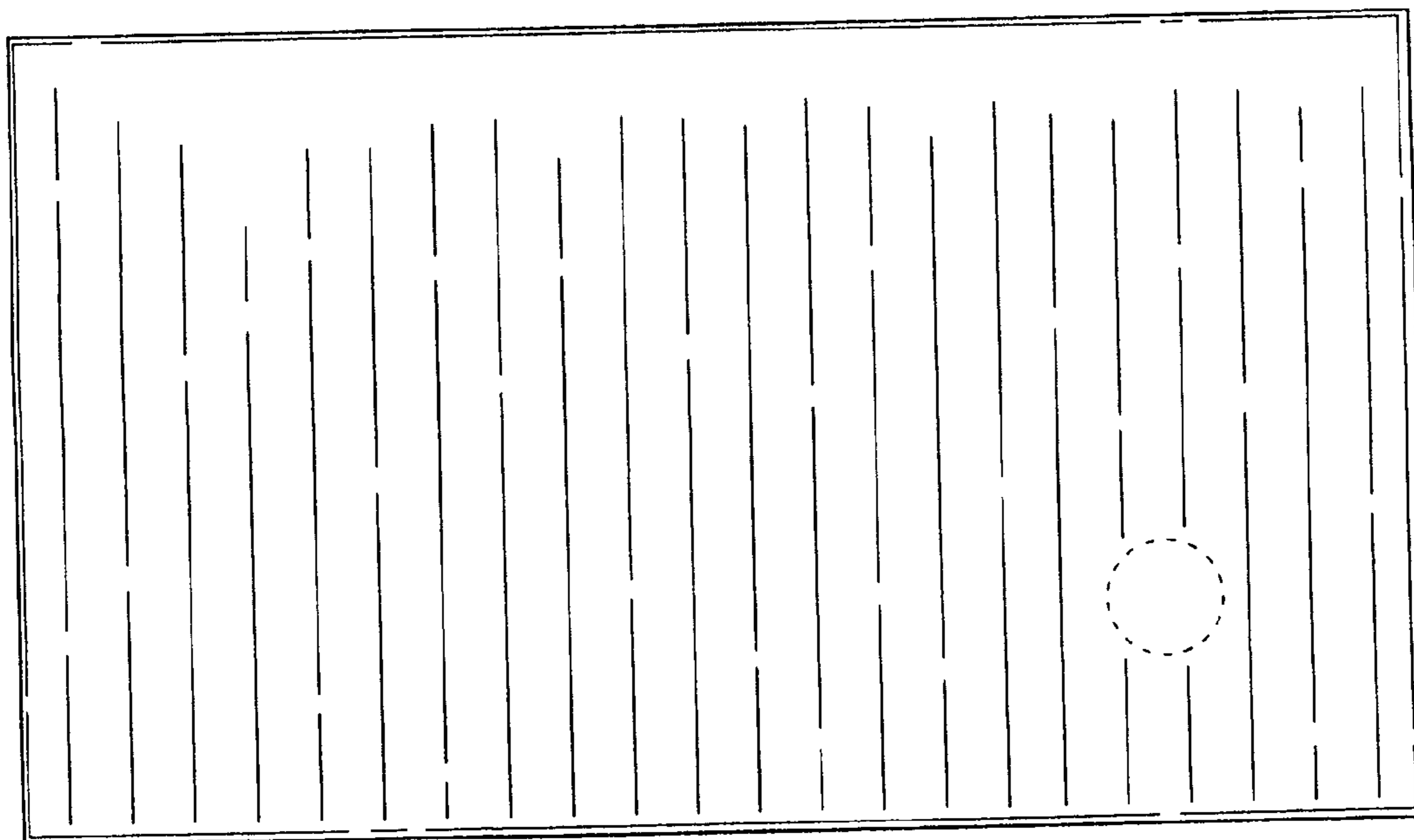

Fig. 3

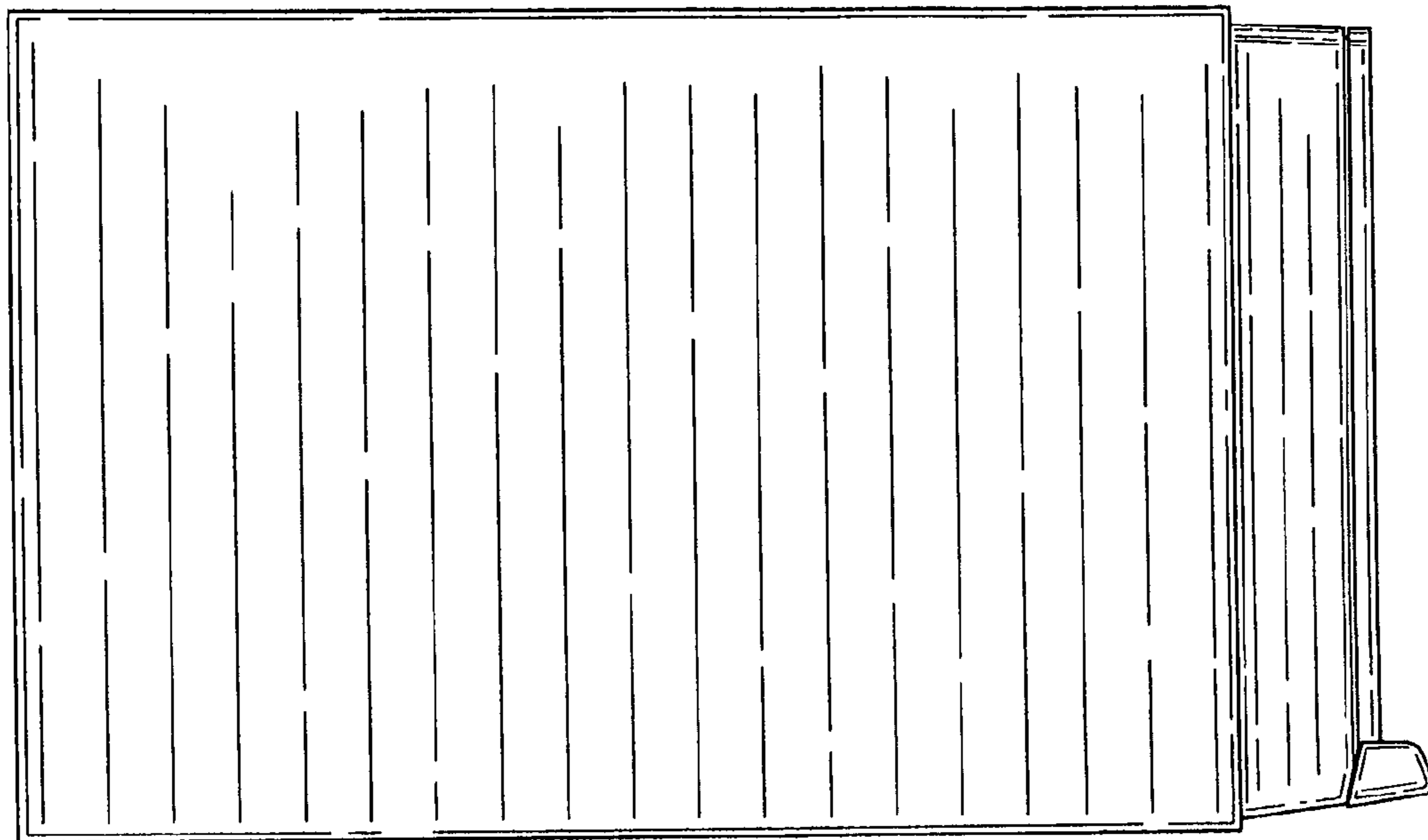

Fig. 4

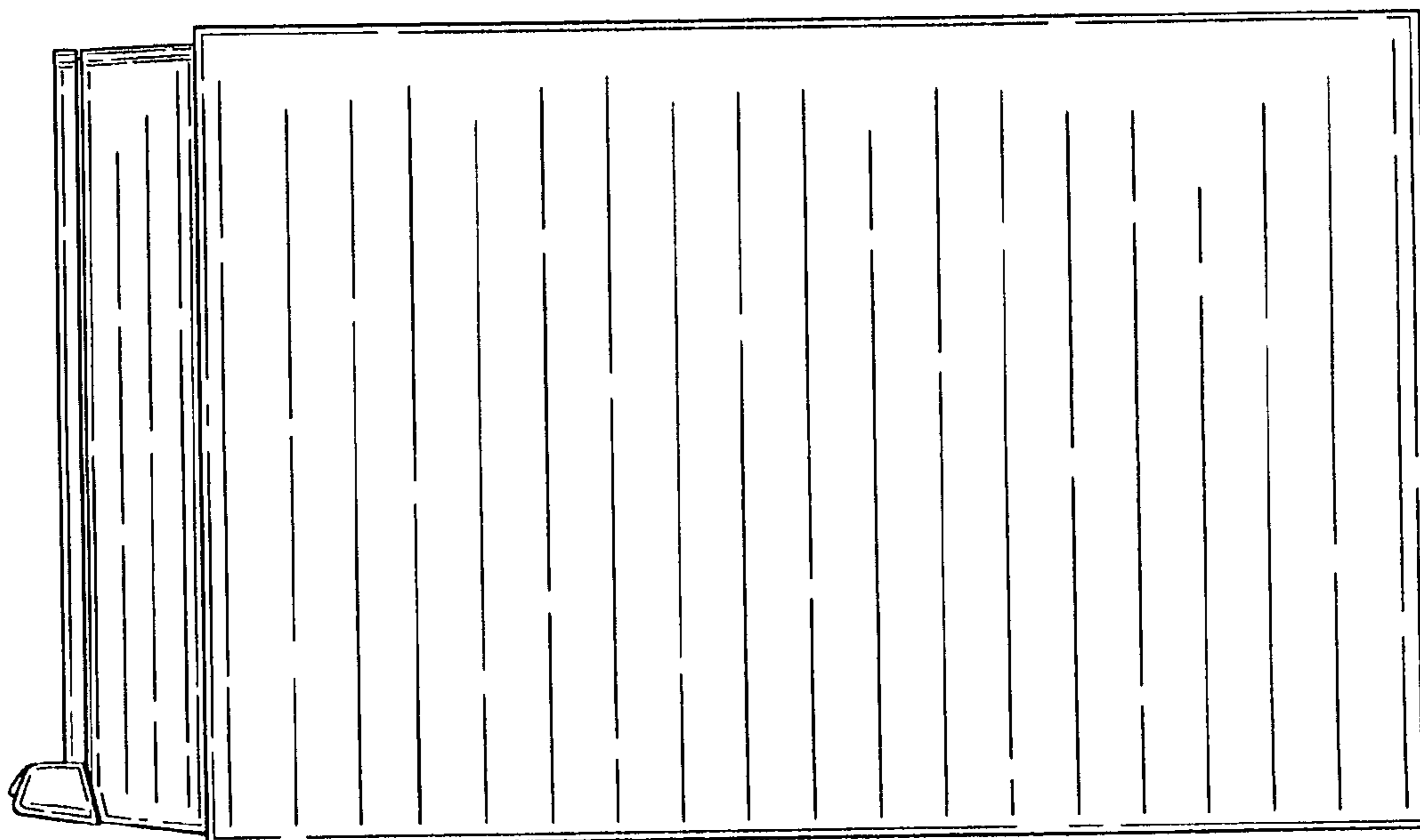

Fig. 5

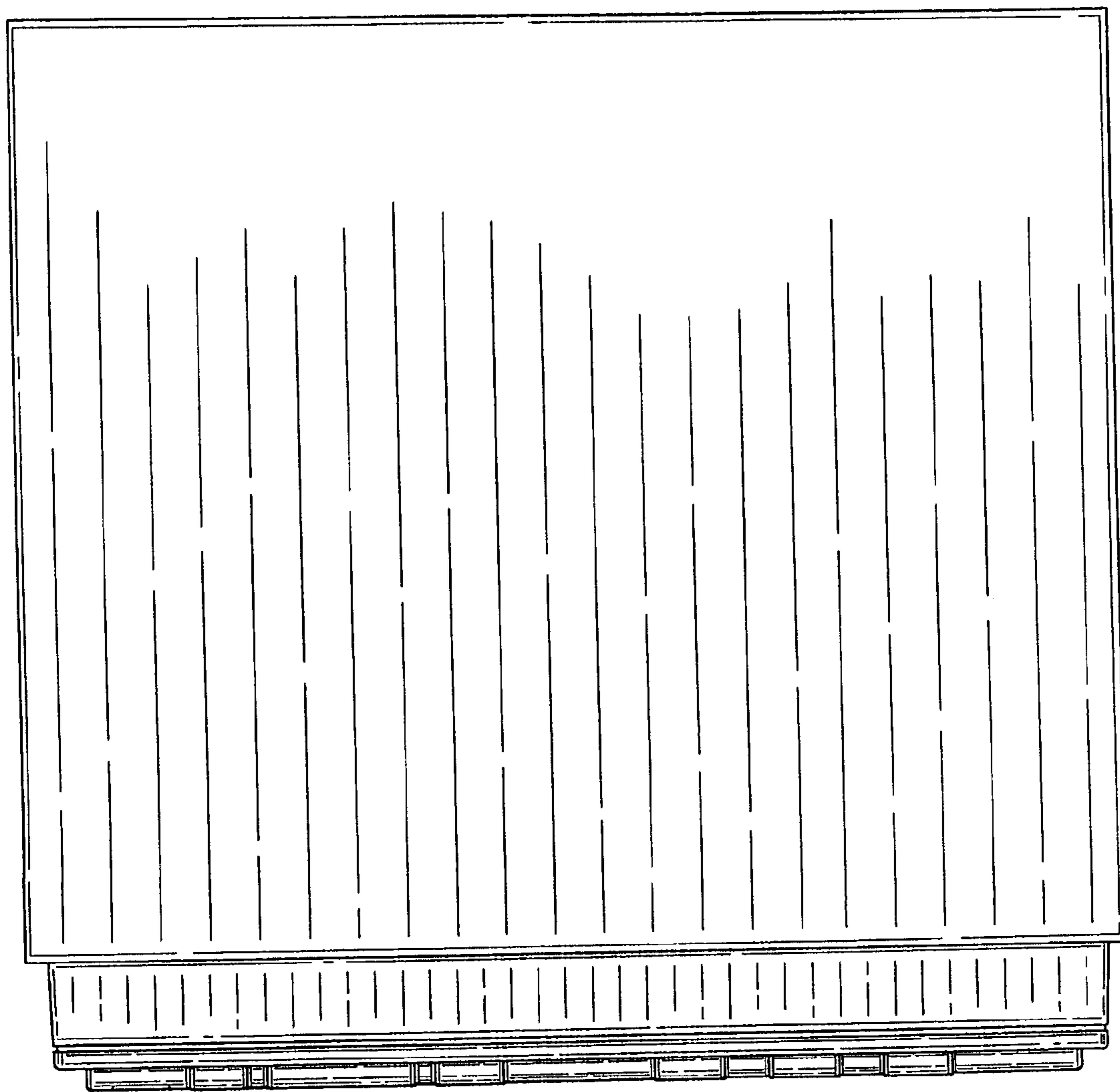

Fig. 6

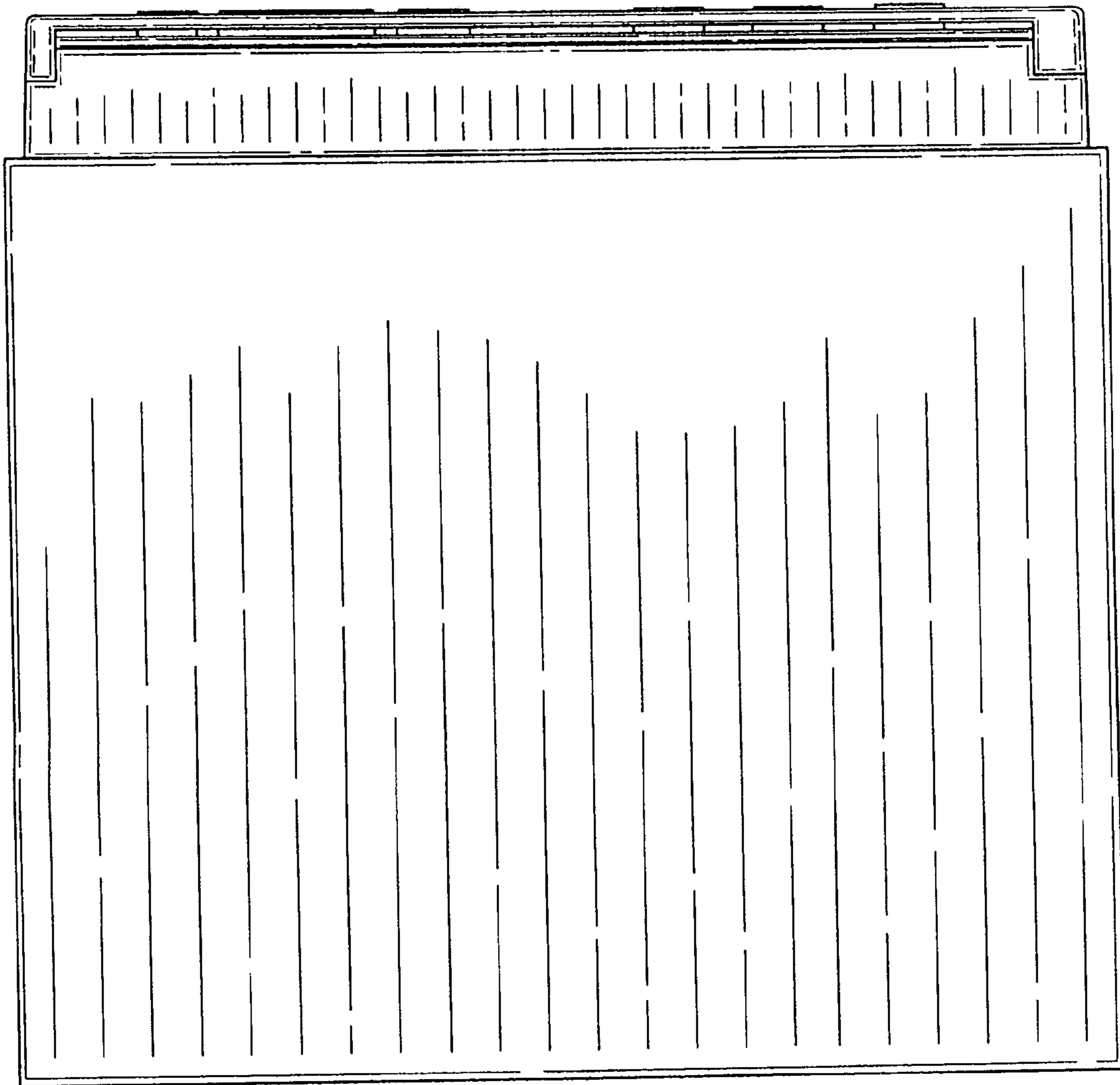

Fig. 7

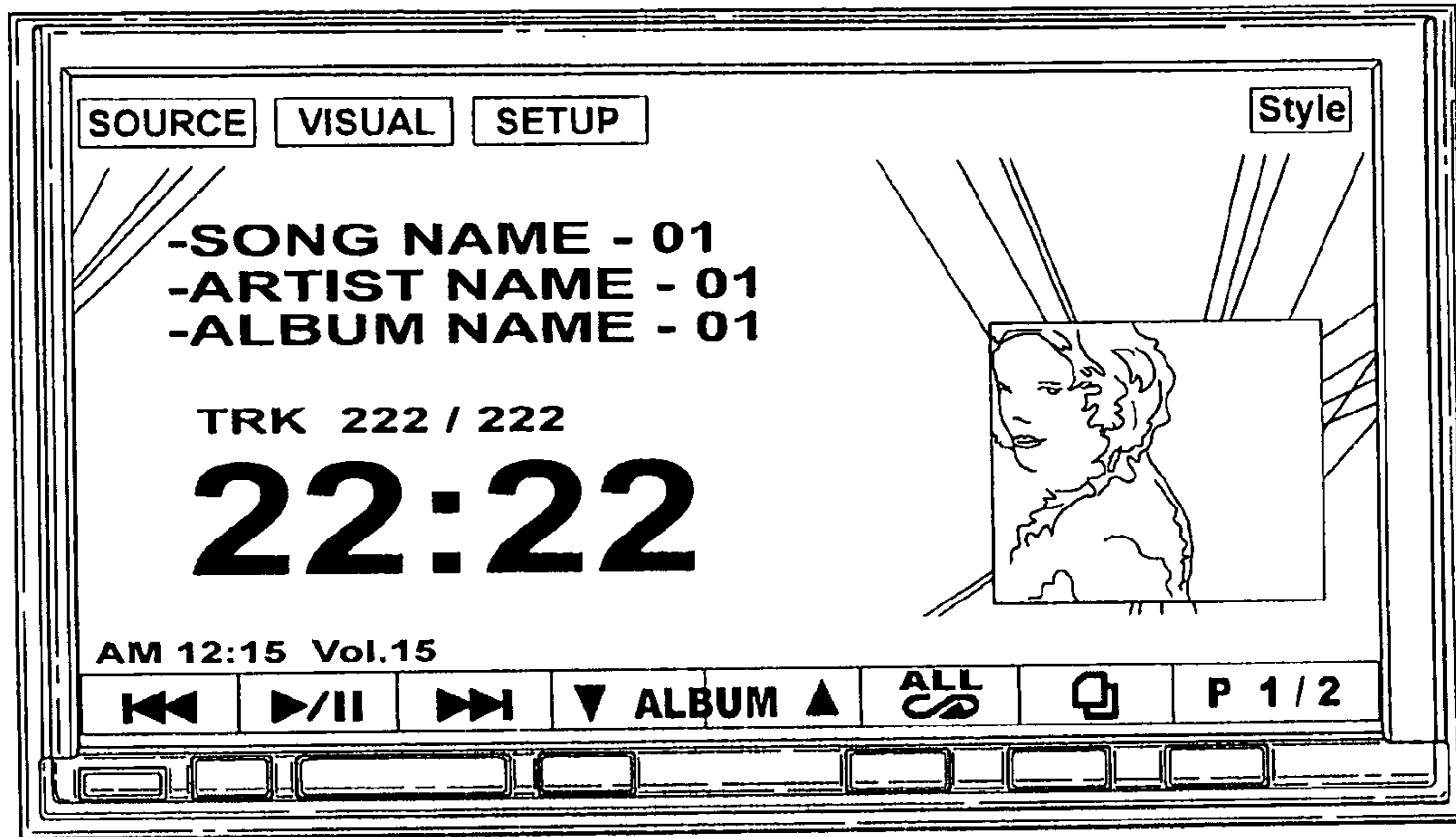

Fig. 8

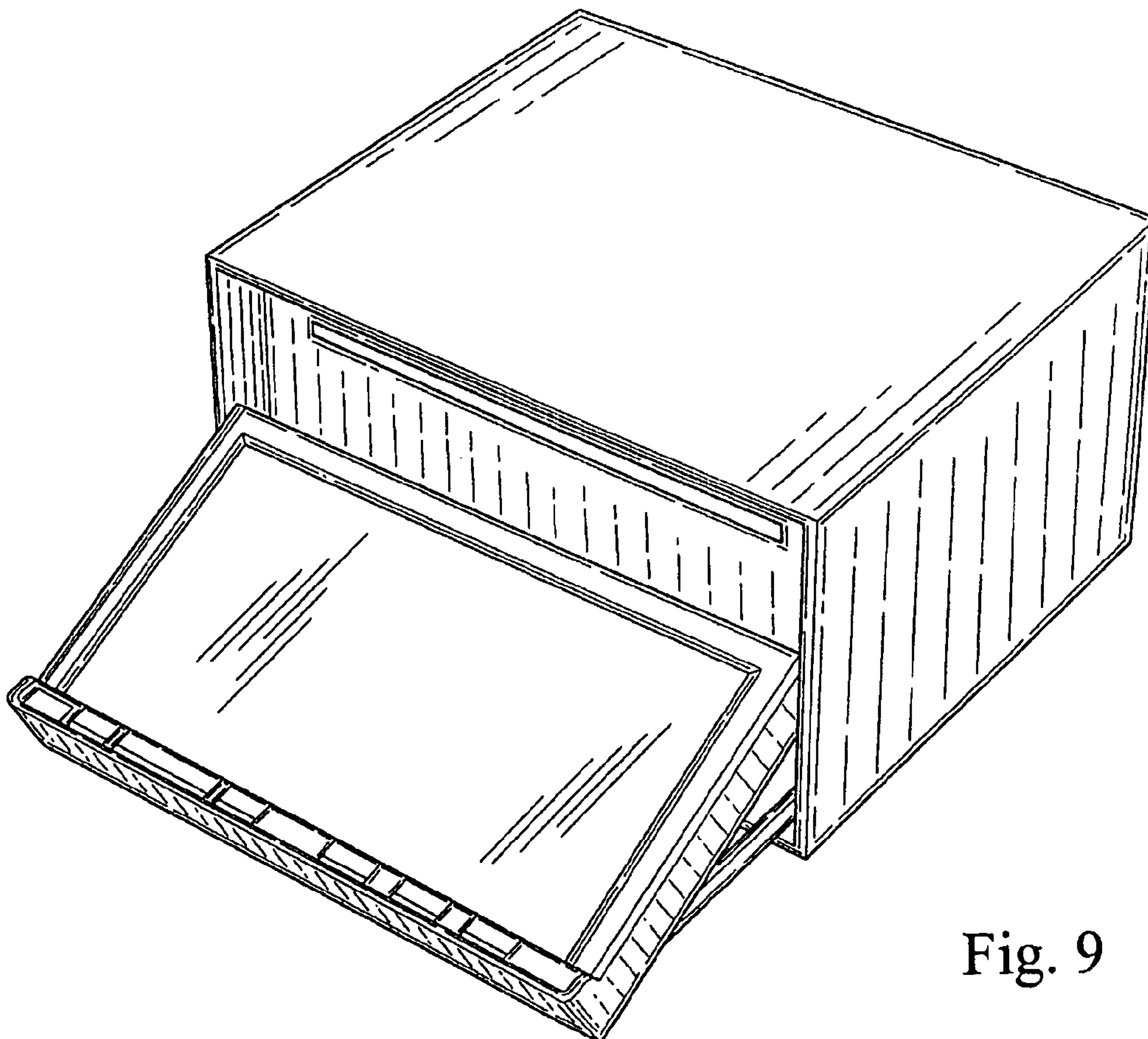

Fig. 9