



US00D582802S

(12) **United States Design Patent**  
**Branson et al.**

(10) **Patent No.:** **US D582,802 S**

(45) **Date of Patent:** **\*\* Dec. 16, 2008**

(54) **THERMOSTAT**

(75) Inventors: **Michael W. Branson**, Noblesville, IN (US); **Tim Comerford**, Indianapolis, IN (US); **James Stenz**, Fenton, MI (US)

(73) Assignee: **Carrier Corporation**, Farmington, CT (US)

(\*\*) Term: **14 Years**

(21) Appl. No.: **29/294,651**

(22) Filed: **Jan. 18, 2008**

(51) **LOC (8) Cl.** ..... **10-04**

(52) **U.S. Cl.** ..... **D10/50**

(58) **Field of Classification Search** ..... D10/49-50;  
236/46 R, 47, 49.3, 51, 84, 94; 400/485  
See application file for complete search history.

(56) **References Cited**

**U.S. PATENT DOCUMENTS**

D255,103 S	5/1980	Wolfe
D268,252 S	3/1983	Chambers
D304,911 S	12/1989	Parker et al.
D315,519 S	3/1991	Odom, Jr. et al.
D359,459 S	6/1995	Summa et al.
D360,146 S	7/1995	Gaskell et al.
D386,989 S	12/1997	Gee, II
D386,990 S	12/1997	Gee, II
D403,972 S	1/1999	Gaskell et al.
D412,672 S	8/1999	Ohlwine et al.
D413,073 S	8/1999	Brechbill et al.
D425,801 S	5/2000	Brechbill et al.
D429,169 S	8/2000	Ohlwine et al.
D518,744 S	4/2006	Rosen
D524,663 S	7/2006	Moore
D525,154 S	7/2006	Moore
D527,658 S	9/2006	Moore
D531,527 S	11/2006	Moore

D536,271 S	2/2007	Moore	
D541,184 S	*	4/2007	Barton et al. .... D10/50
D556,060 S		11/2007	McGuire et al.
D556,061 S		11/2007	Rosen
D556,608 S		12/2007	Rhodes
D571,675 S	*	6/2008	Skaf et al. .... D10/50

\* cited by examiner

*Primary Examiner*—Antoine D Davis

(74) *Attorney, Agent, or Firm*—Kinney & Lange PA

(57) **CLAIM**

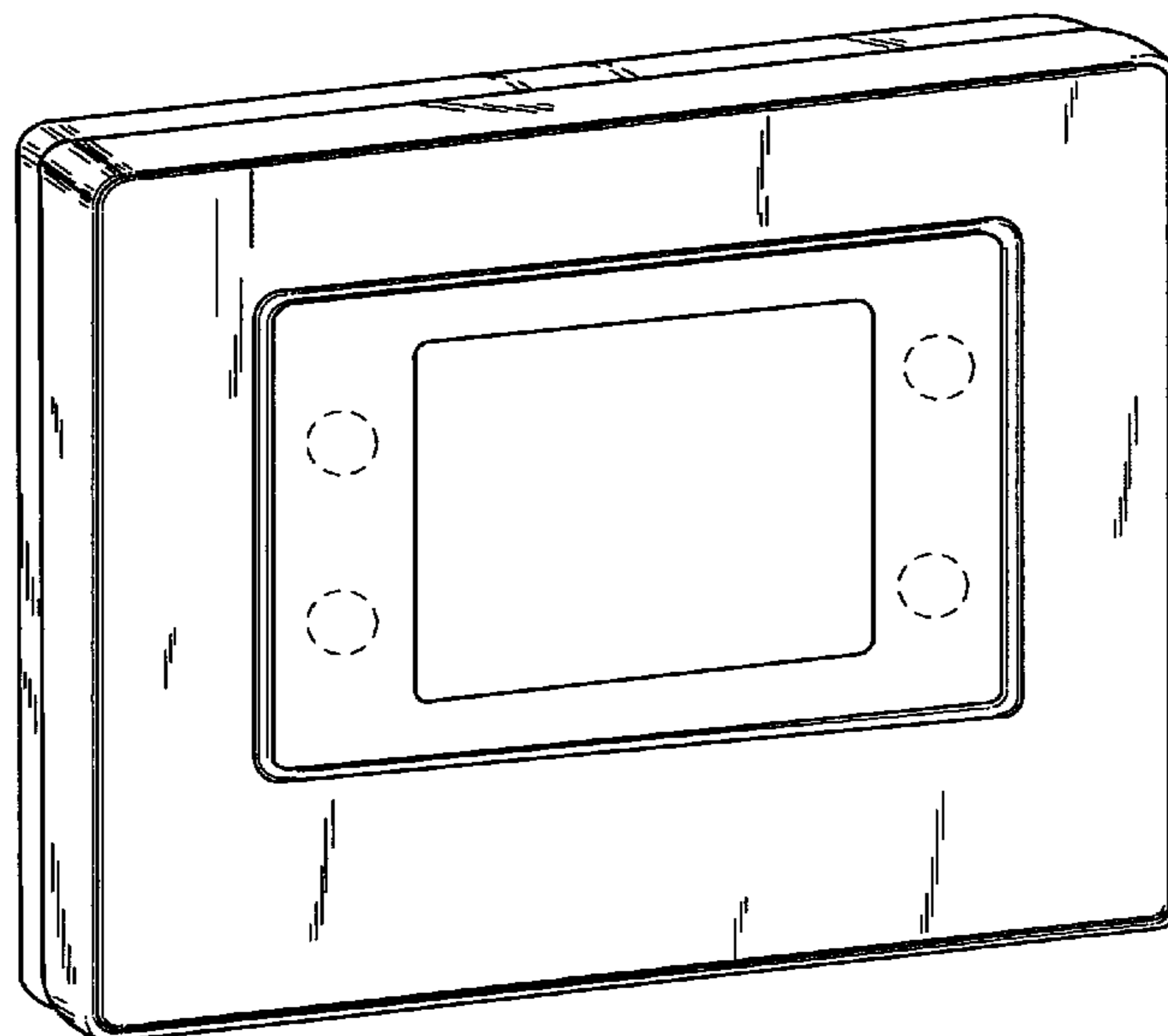
The ornamental design for a thermostat, as shown and described.

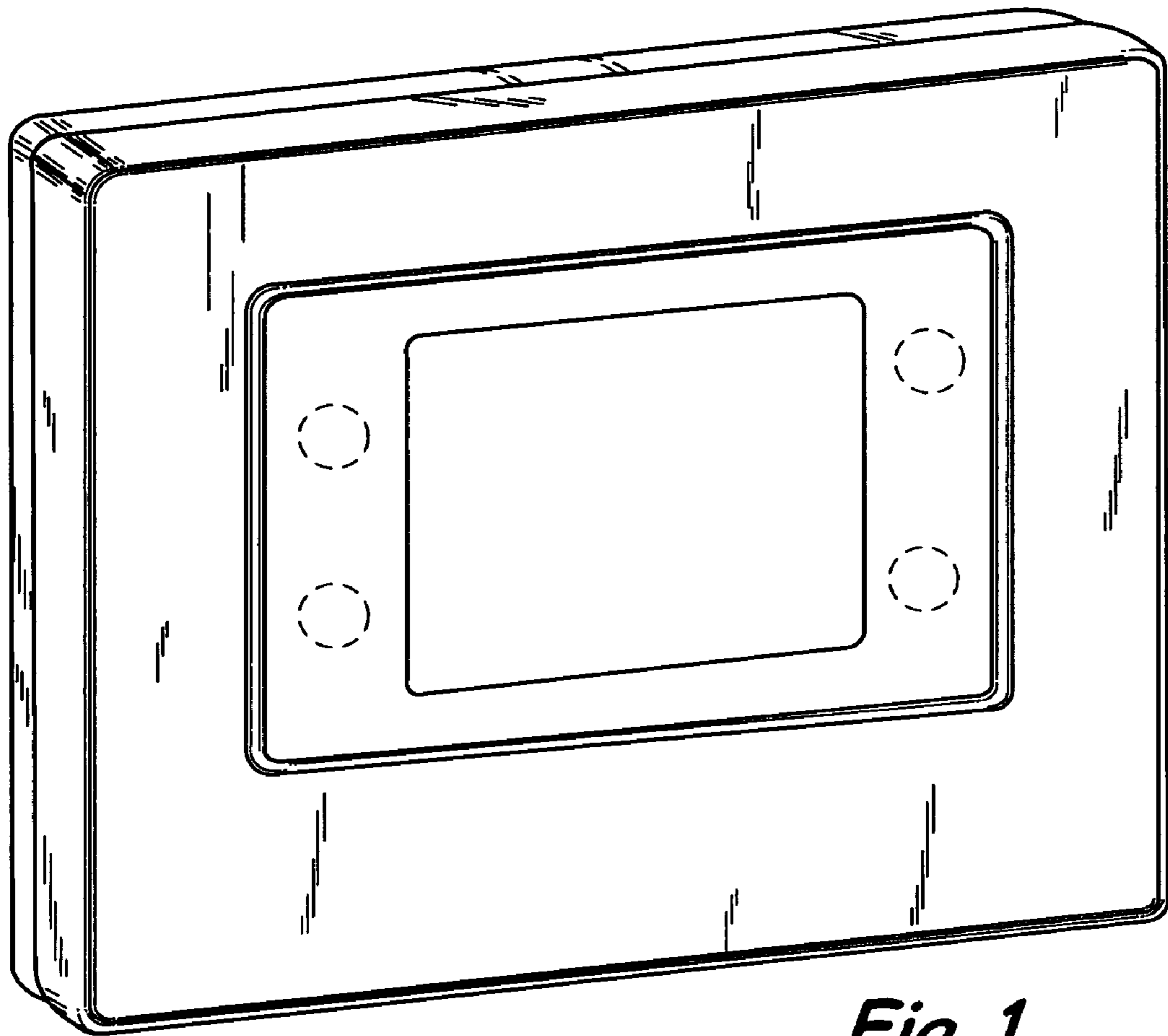
**DESCRIPTION**

FIG. 1 is a perspective view of a first embodiment;  
 FIG. 2 is a right side view of a first embodiment;  
 FIG. 3 is a left side view of a first embodiment;  
 FIG. 4 is a front view of a first embodiment;  
 FIG. 5 is a rear view of a first embodiment;  
 FIG. 6 is a top view of a first embodiment;  
 FIG. 7 is a bottom view of a first embodiment;  
 FIG. 8 is a perspective view of a second embodiment;  
 FIG. 9 is a right side view of a second embodiment;  
 FIG. 10 is a left side view of a second embodiment;  
 FIG. 11 is a front view of a second embodiment;  
 FIG. 12 is a rear view of a second embodiment;  
 FIG. 13 is a top view of a second embodiment; and,  
 FIG. 14 is a bottom view of a second embodiment.

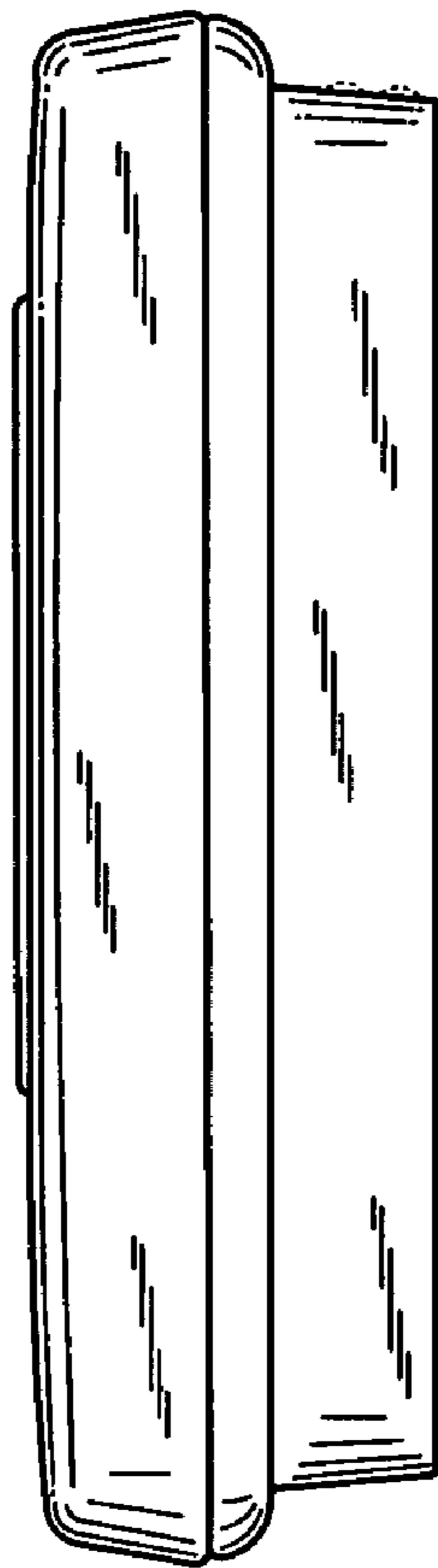
The broken lines in the Figures are for environmental purposes only and form no part of the claimed design.

**1 Claim, 8 Drawing Sheets**

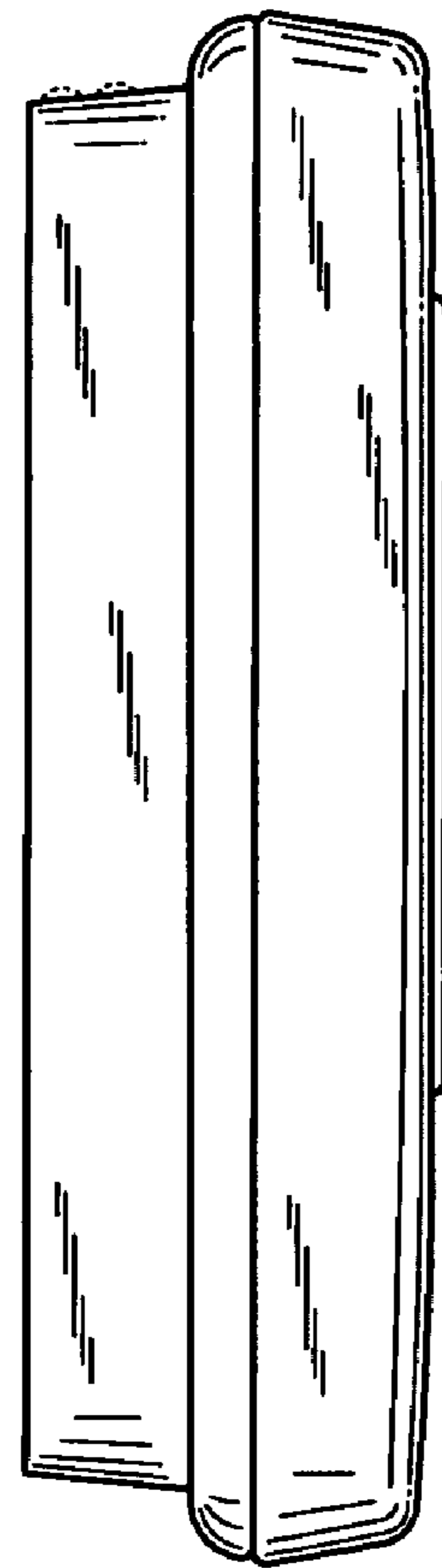




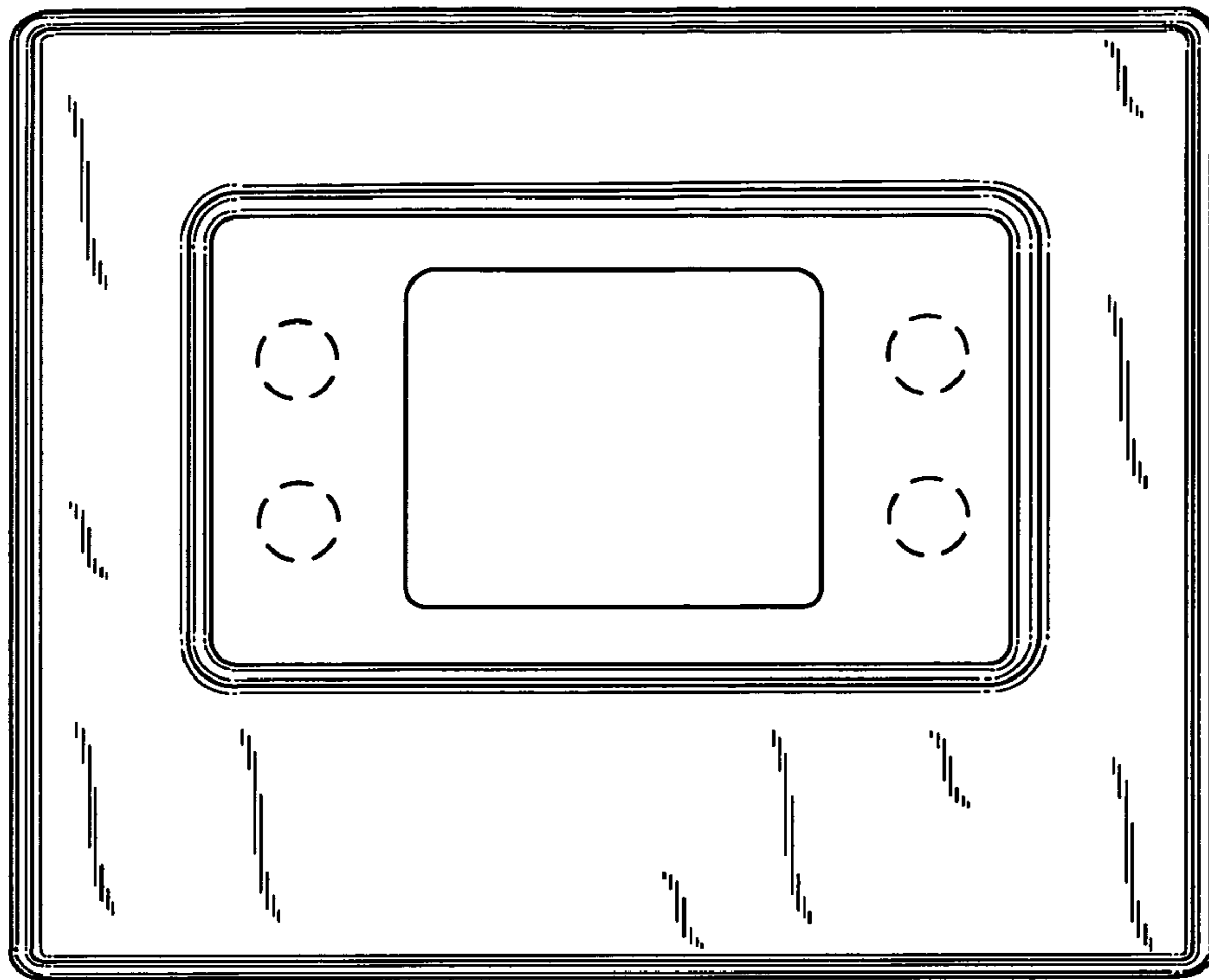
*Fig. 1*



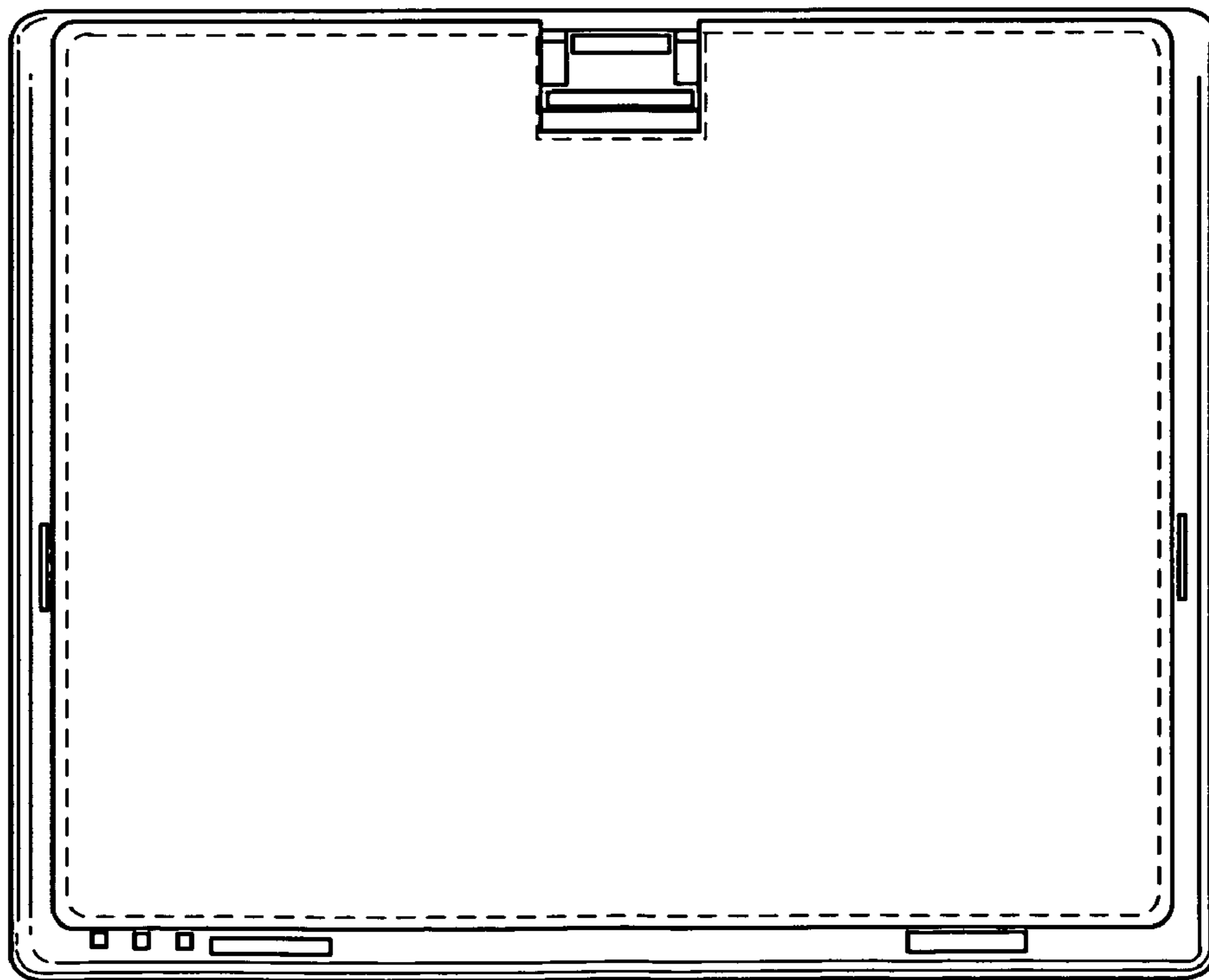
*Fig. 2*



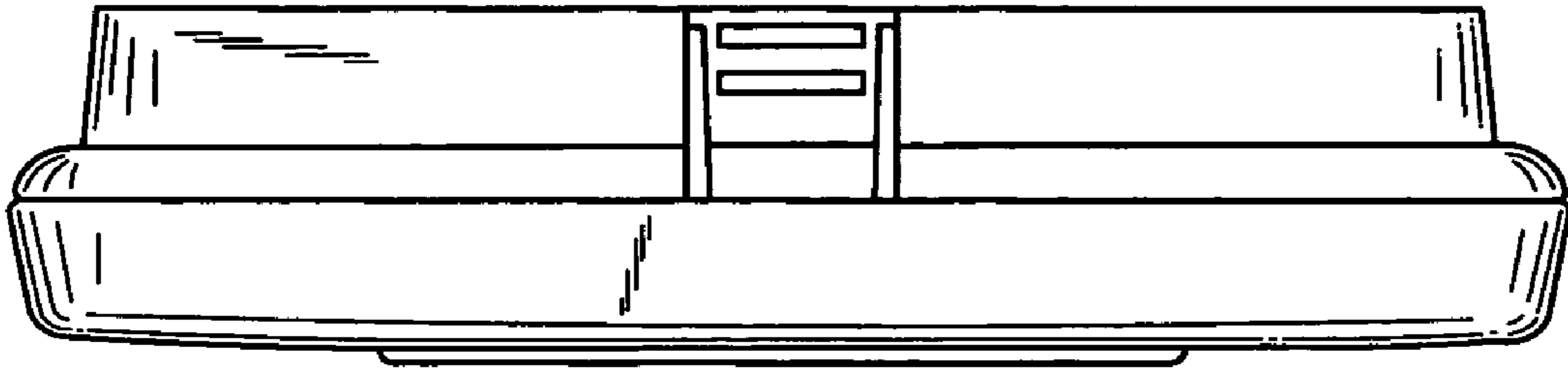
*Fig. 3*



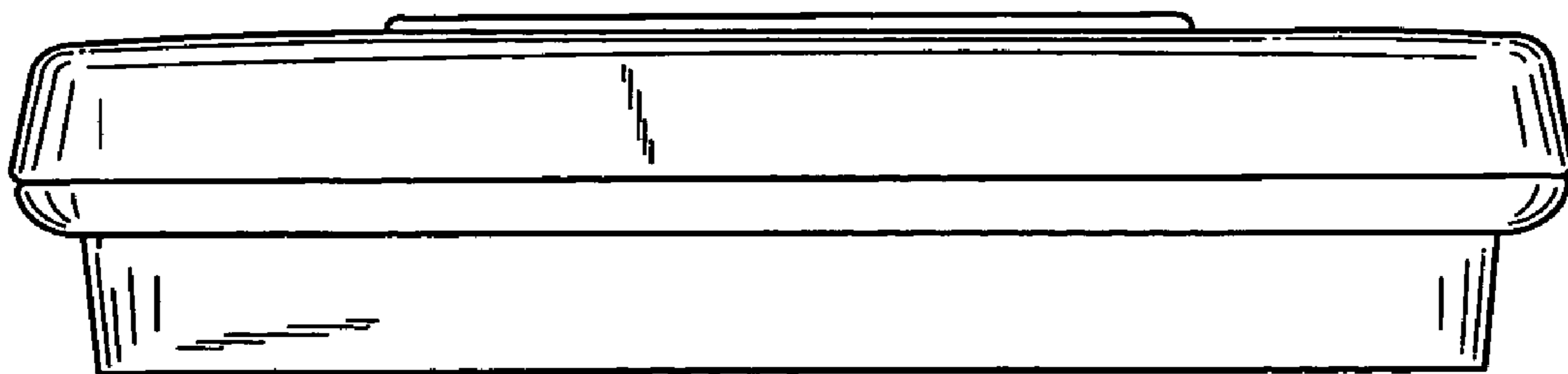
*Fig. 4*



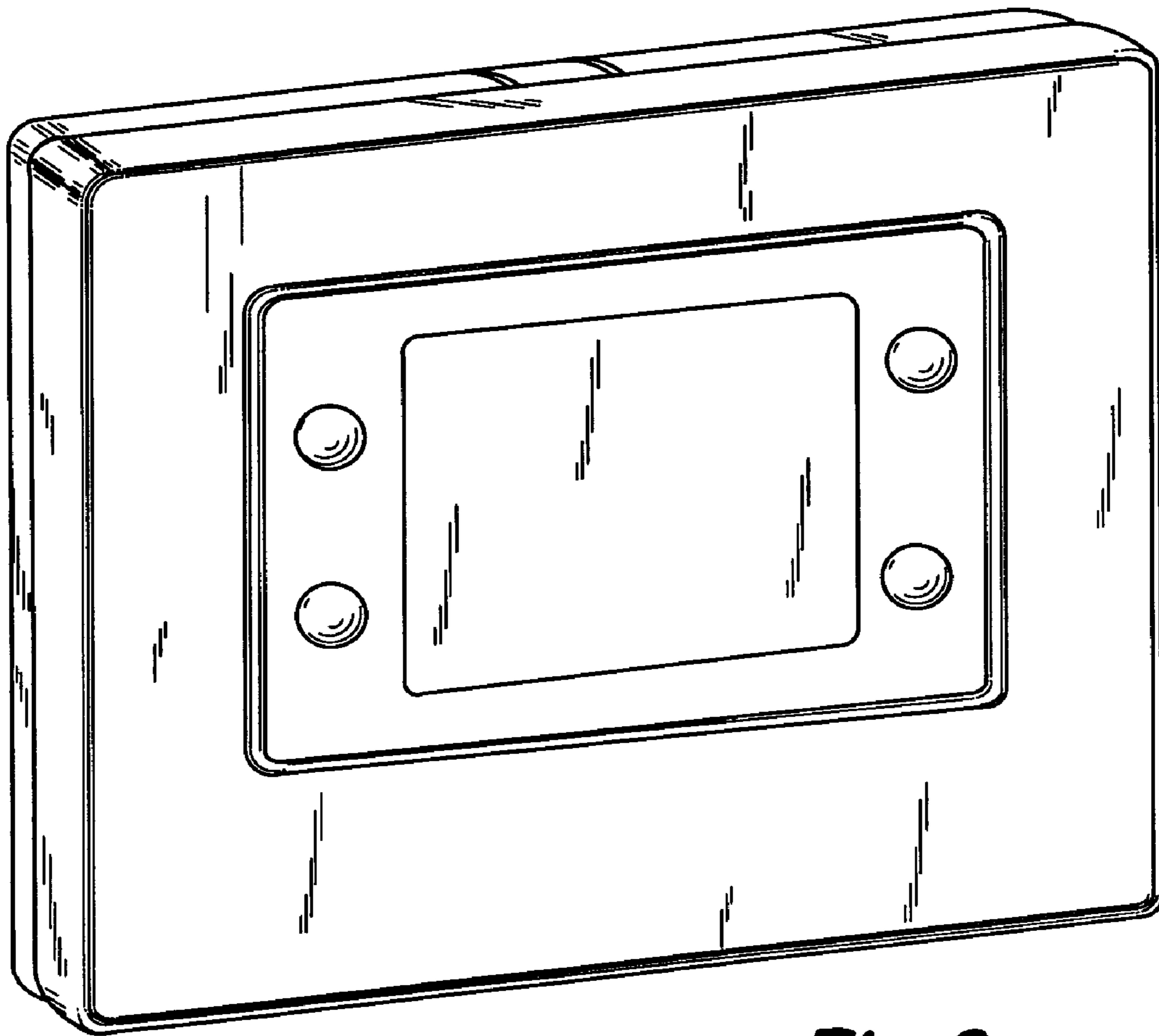
*Fig. 5*



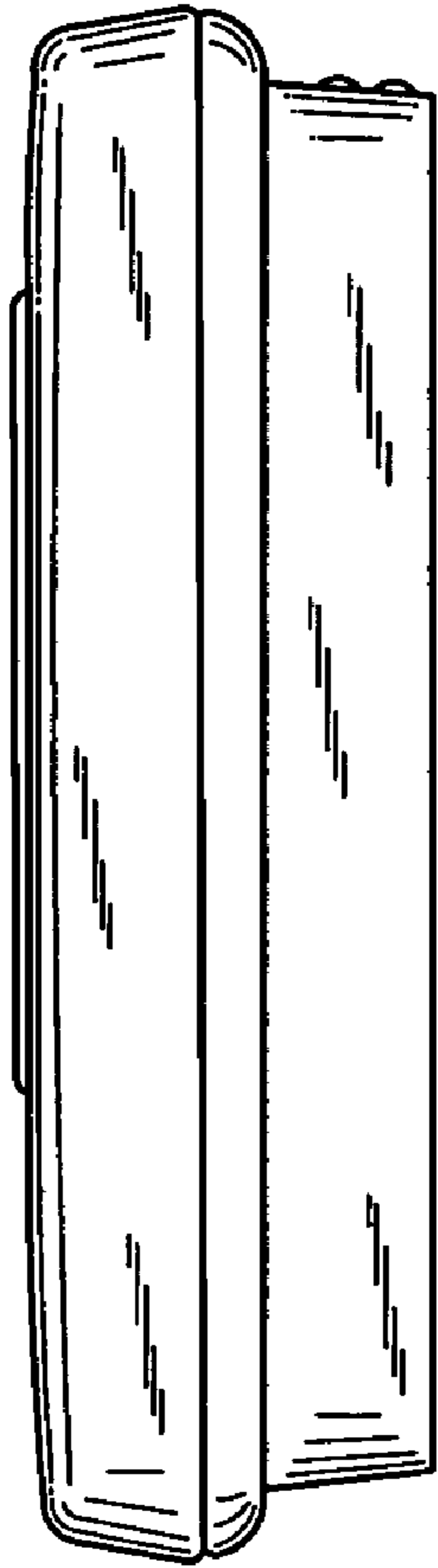
*Fig. 6*



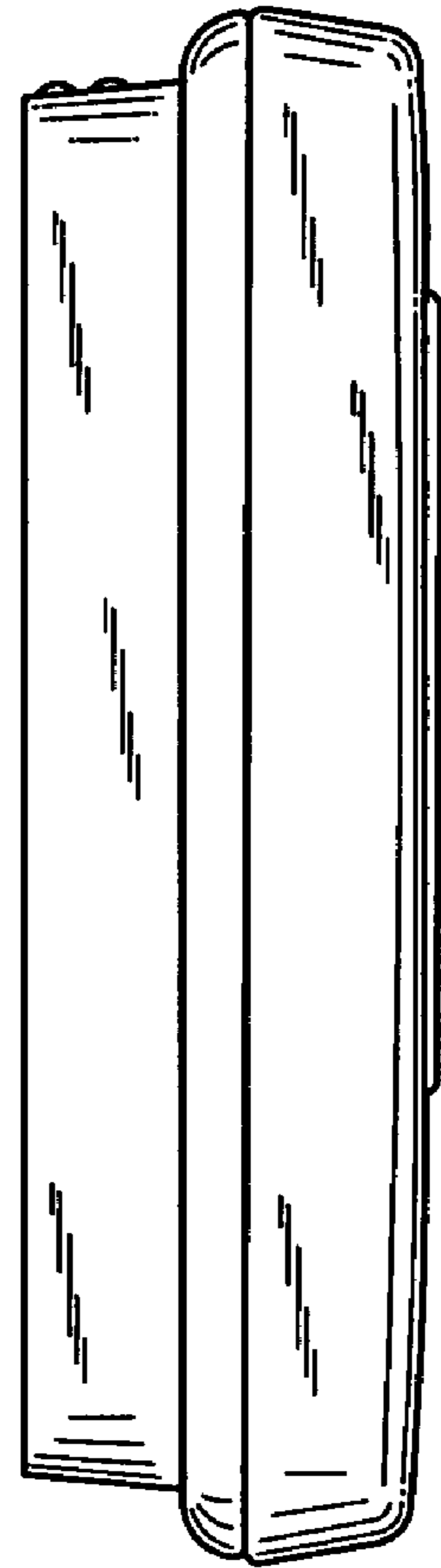
*Fig. 7*



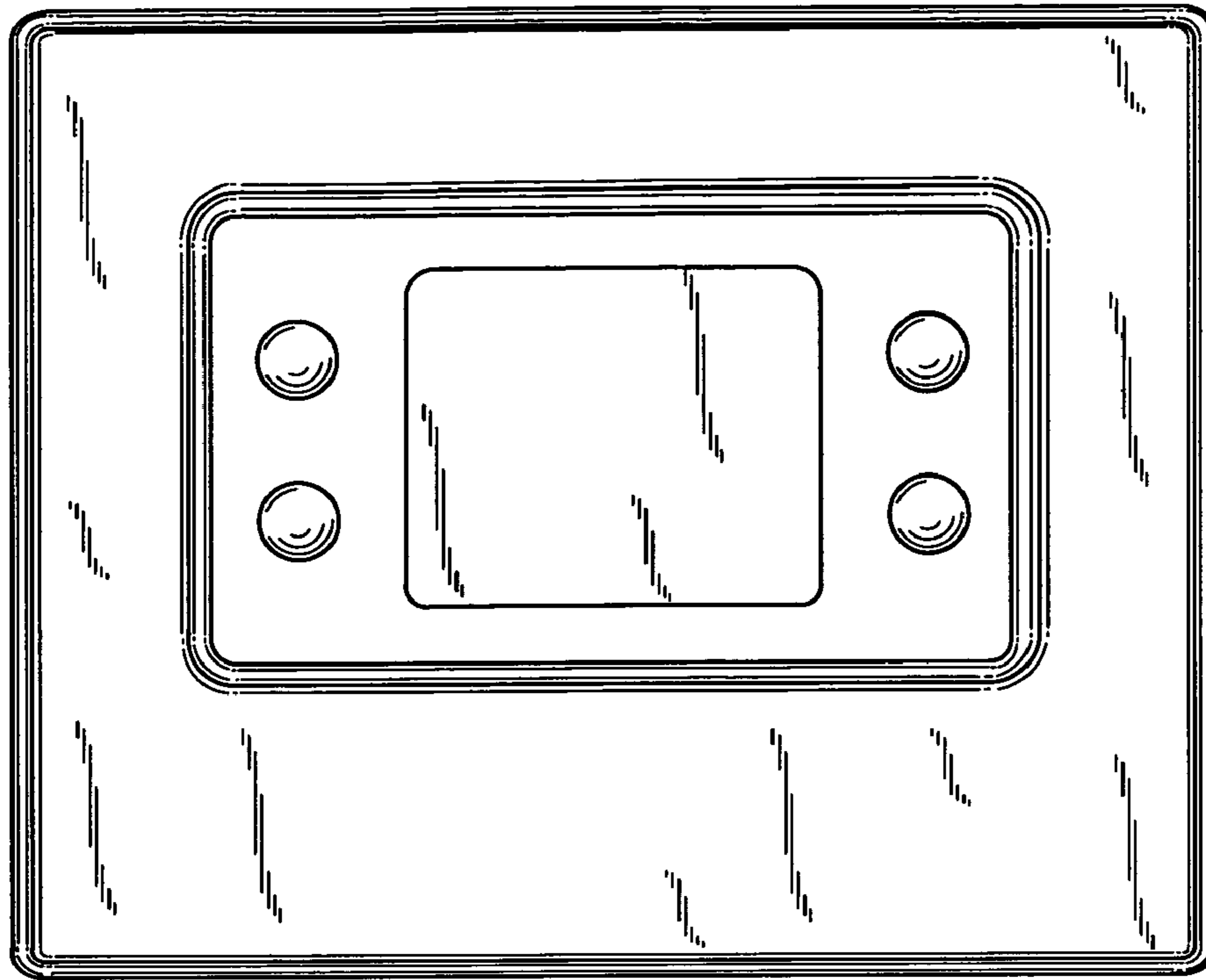
*Fig. 8*



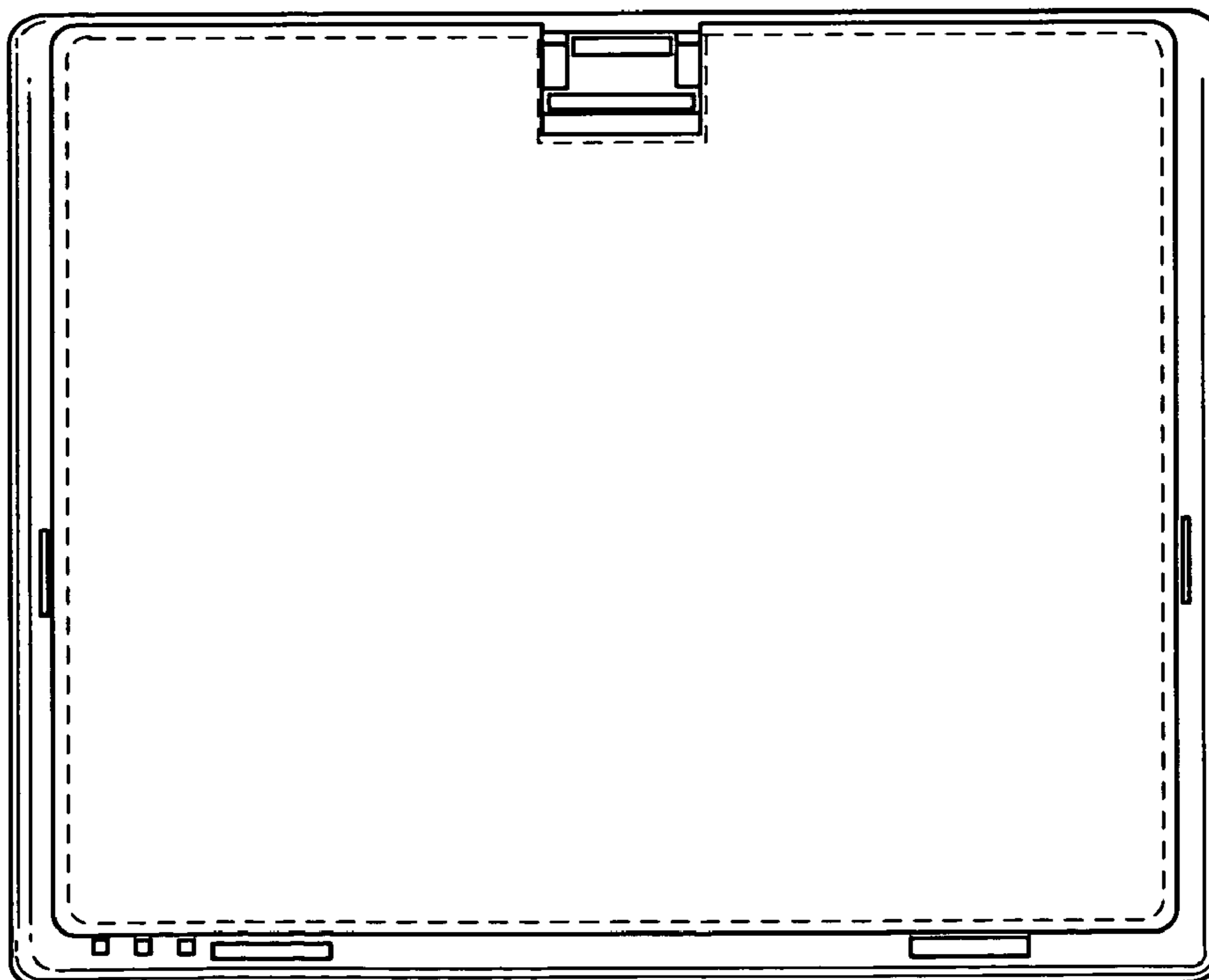
*Fig. 9*



*Fig. 10*

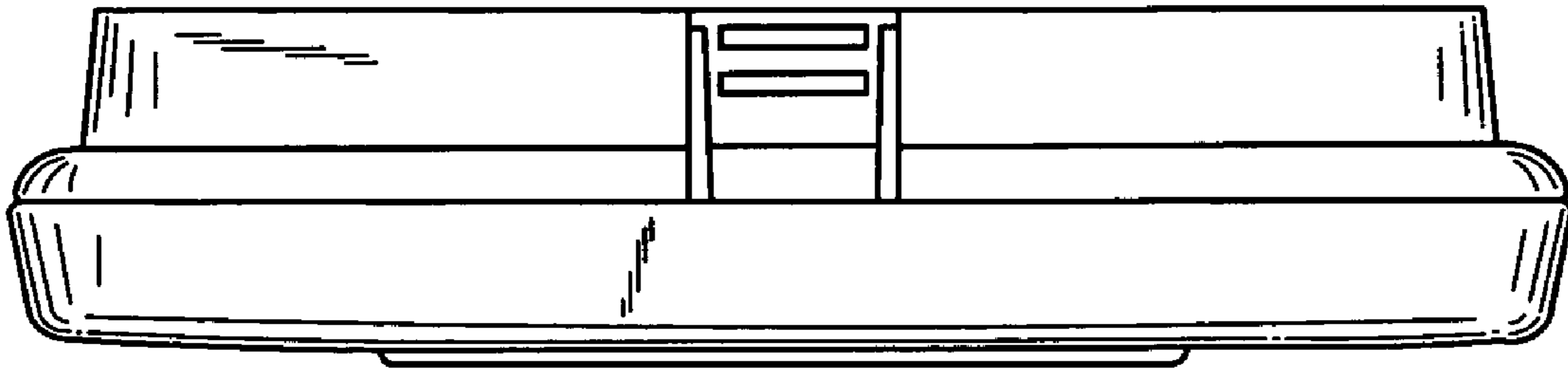


*Fig. 11*

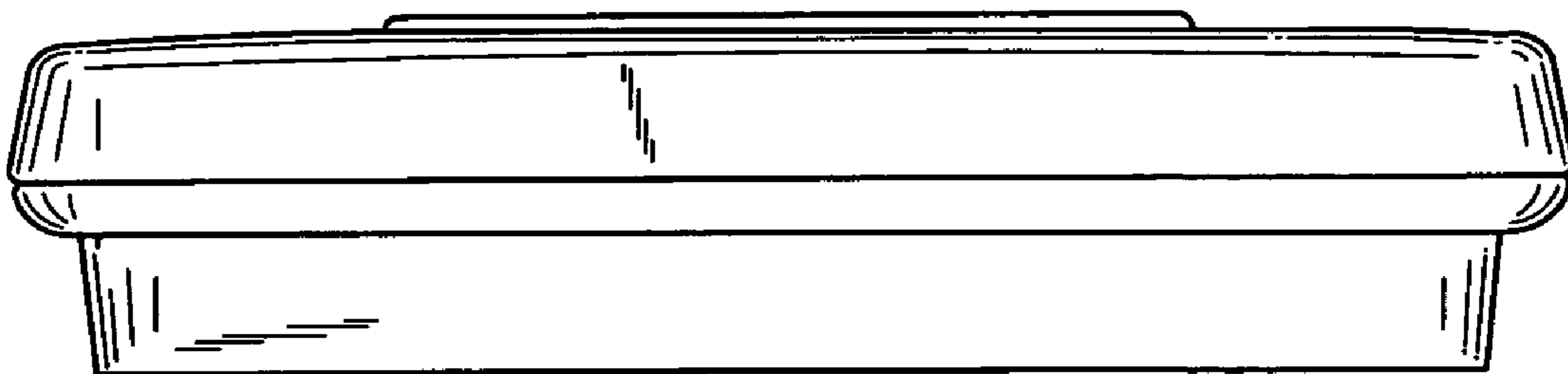


*Fig. 12*





*Fig. 13*



*Fig. 14*