



US00D582770S

(12) **United States Design Patent**
Turchi

(10) **Patent No.:** **US D582,770 S**
(45) **Date of Patent:** **** Dec. 16, 2008**

(54) **DISPENSING PUMP HEAD**

(75) Inventor: **Mario Alexander Turchi**, Edgewater,
NJ (US)

(73) Assignee: **Reckitt Benckiser Inc.**, Parsippany, NJ
(US)

(**) Term: **14 Years**

(21) Appl. No.: **29/306,111**

(22) Filed: **Apr. 2, 2008**

(30) **Foreign Application Priority Data**

Oct. 8, 2007 (EM) 000803374

(51) **LOC (8) Cl.** **09-07**

(52) **U.S. Cl.** **D9/448**

(58) **Field of Classification Search** D9/688,
D9/686, 685, 682, 448, 447; D23/238, 226,
D23/213; 222/402.15, 383.1, 153.11, 153.02
See application file for complete search history.

(56) **References Cited**

U.S. PATENT DOCUMENTS

- 4,168,788 A * 9/1979 Quinn 222/383.1
- D358,198 S * 5/1995 Wadsworth D23/226
- D366,692 S * 1/1996 Wadsworth D23/213
- D377,602 S * 1/1997 Wadsworth D9/448
- D381,581 S * 7/1997 Wadsworth D9/448
- D400,102 S * 10/1998 Tada D9/448
- D406,060 S * 2/1999 Dumont et al. D9/448
- D409,487 S * 5/1999 Wadsworth et al. D9/448
- D409,918 S * 5/1999 Wadsworth et al. D9/448
- D423,934 S * 5/2000 Brozell D9/448
- D437,225 S * 2/2001 Keung D9/448
- 6,332,562 B1 * 12/2001 Sweeton 222/383.1

- D454,787 S * 3/2002 Cummings D9/448
- D456,262 S * 4/2002 Cummings D9/448
- D494,866 S * 8/2004 Guala D9/448
- D521,864 S * 5/2006 Cartoni D9/448
- D525,124 S * 7/2006 Sweeton D9/448
- D525,524 S * 7/2006 Sweeton D9/448
- D525,525 S * 7/2006 Sweeton D9/448
- D530,201 S * 10/2006 Sweeton D9/448
- D535,560 S * 1/2007 Sweeton D9/448
- D541,655 S * 5/2007 Alluigi D9/448
- D550,079 S * 9/2007 Yang D9/448
- D551,549 S * 9/2007 Maas et al. D9/448
- D565,948 S * 4/2008 Maas et al. D9/448

* cited by examiner

Primary Examiner—Susan Bennett Hattan

(57) **CLAIM**

The ornamental design for a dispensing pump head, as shown and described.

DESCRIPTION

FIG. 1 is a front perspective view of a dispensing pump head; FIG. 2 is a front elevation view thereof; the broken line showing of elements behind the trigger and inside the shroud depicting environmental subject matter only and forming no part of the claimed design,

FIG. 3 is an elevation view of the rear thereof;

FIG. 4 is an elevation view of the right side thereof;

FIG. 5 is an elevation view of the left side thereof;

FIG. 6 is a plan view of the top thereof; and,

FIG. 7 is a bottom plan view thereof, the broken line defining boundary of the claimed design and forming no part thereof.

1 Claim, 4 Drawing Sheets

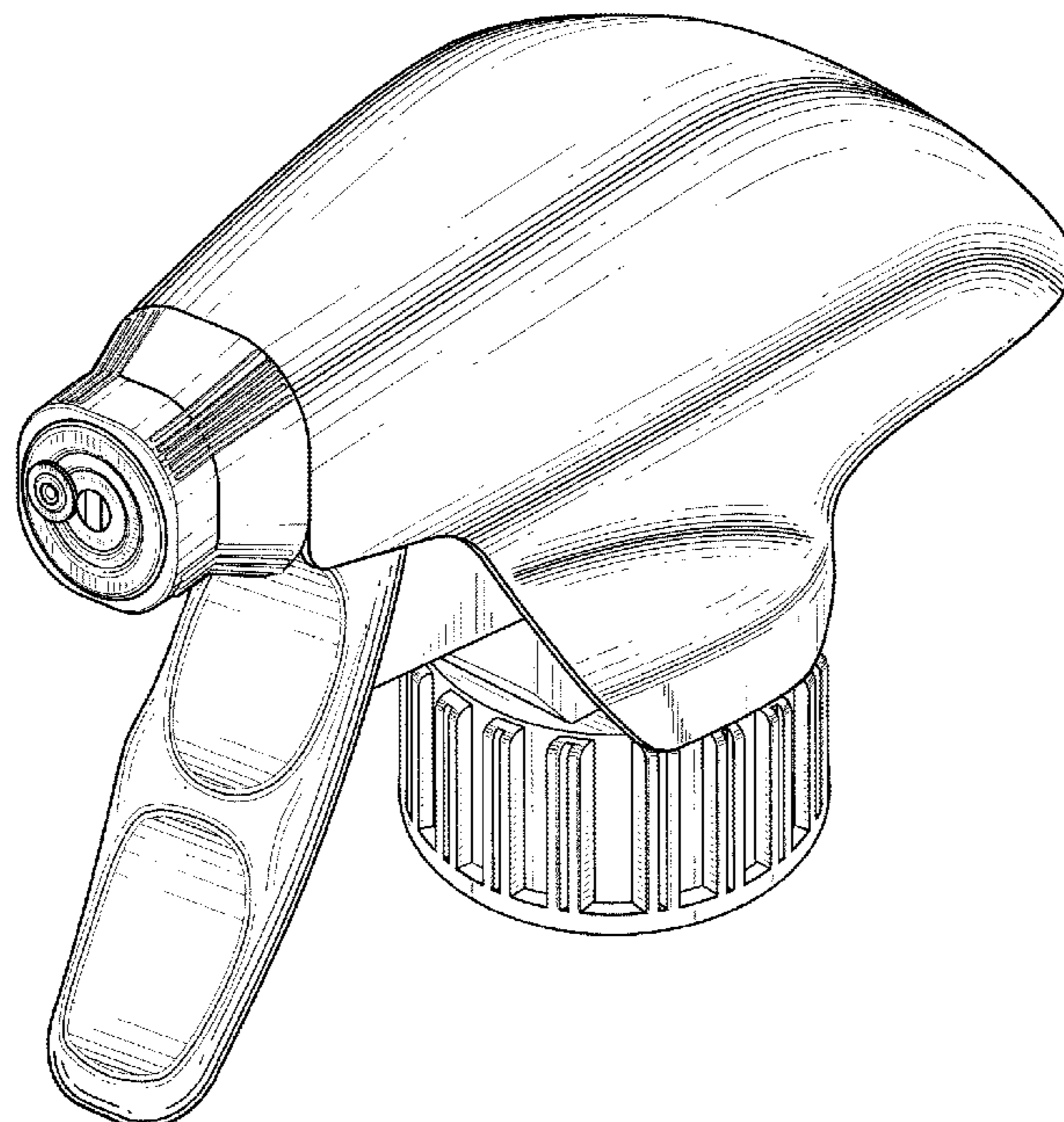

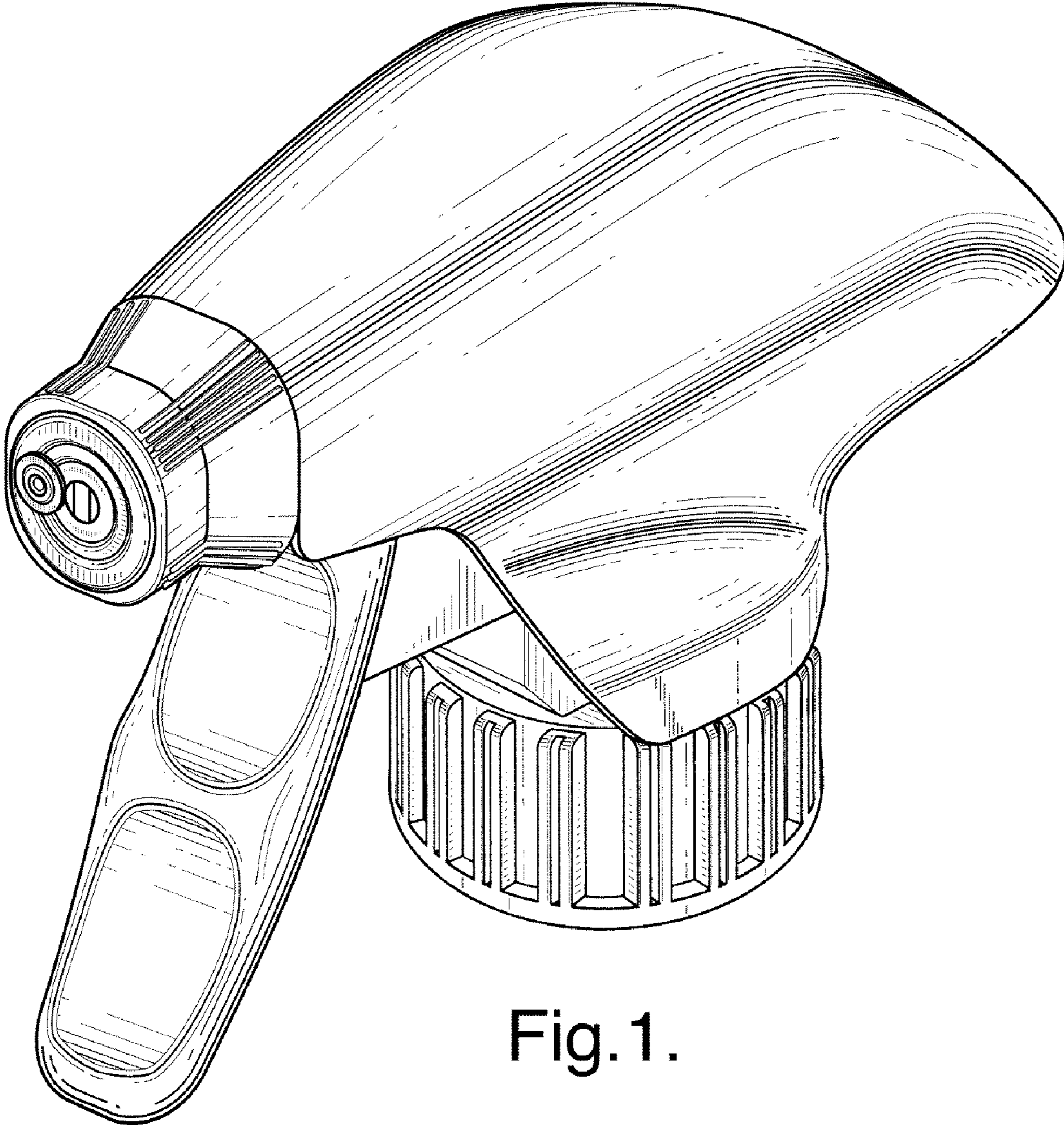

Fig. 1.

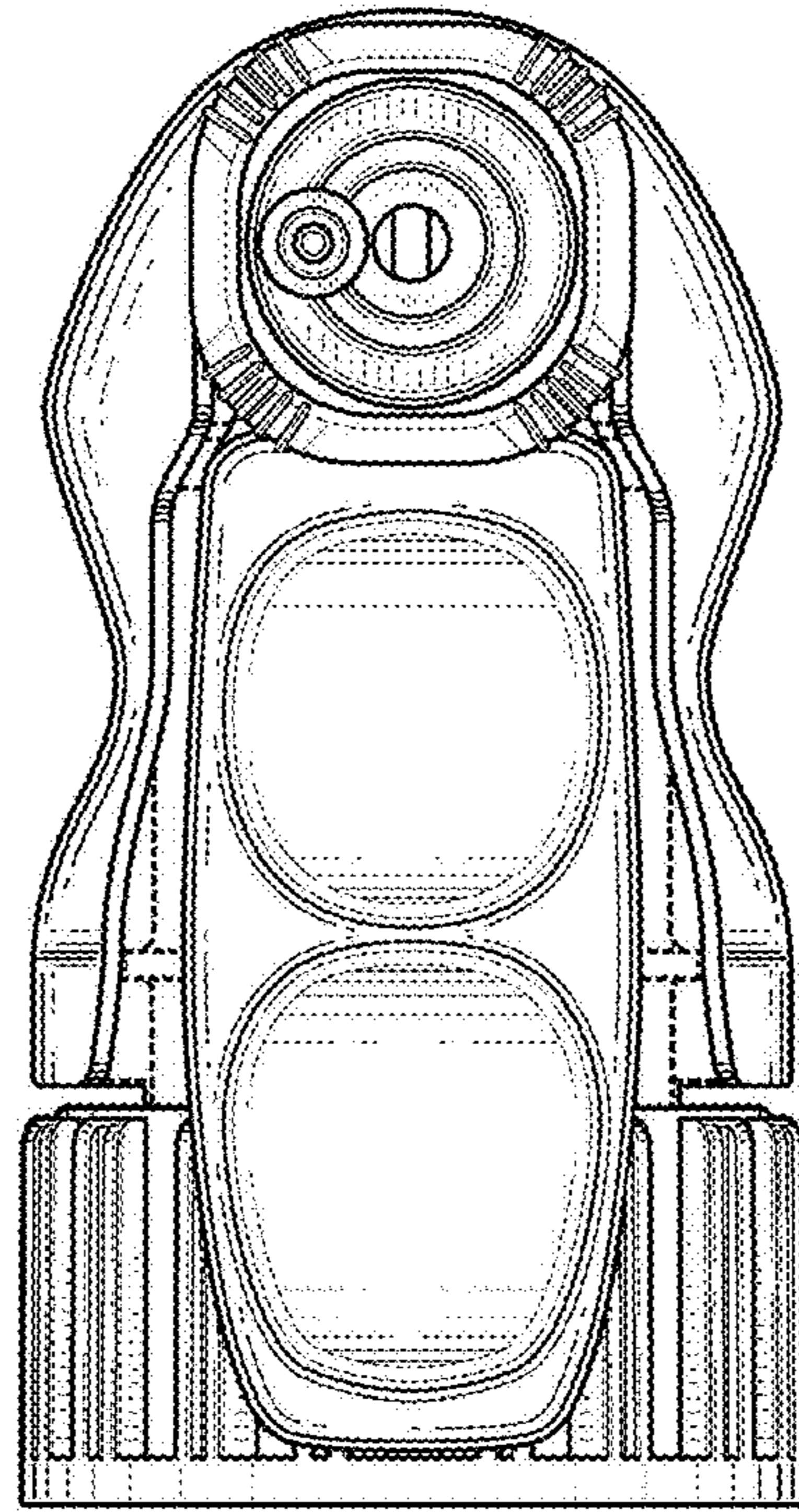

Fig.2.

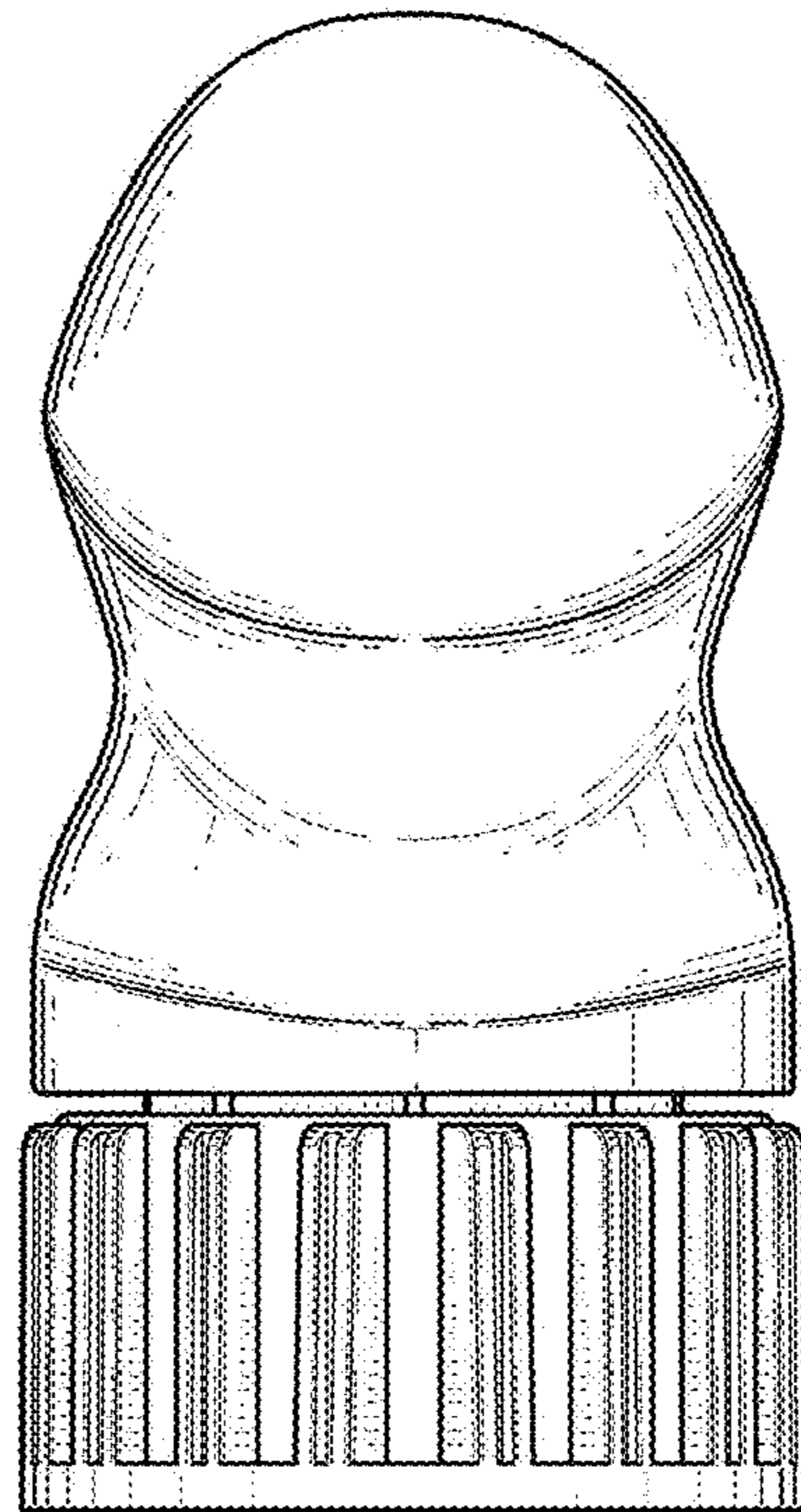

Fig.3.

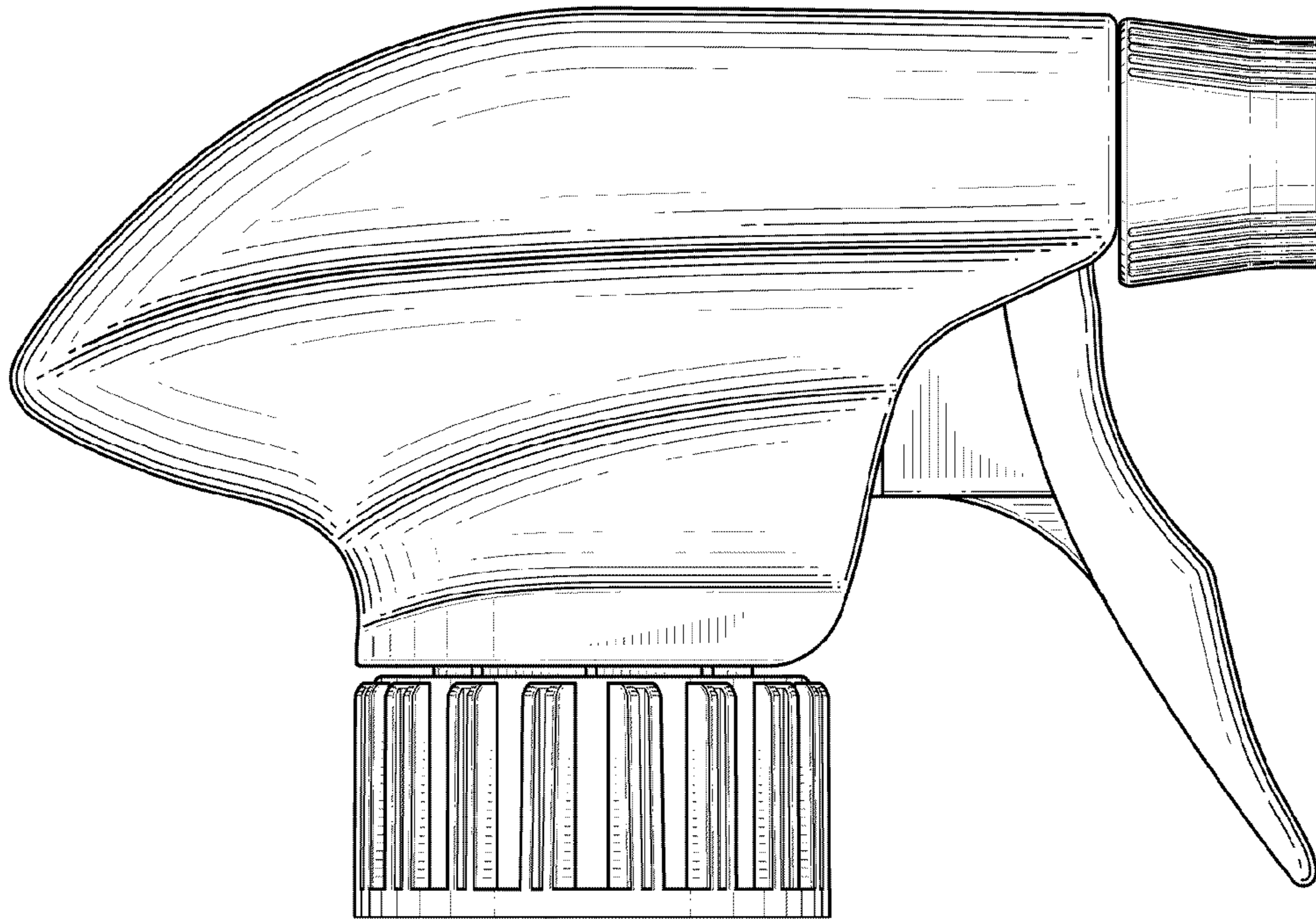

Fig.4.

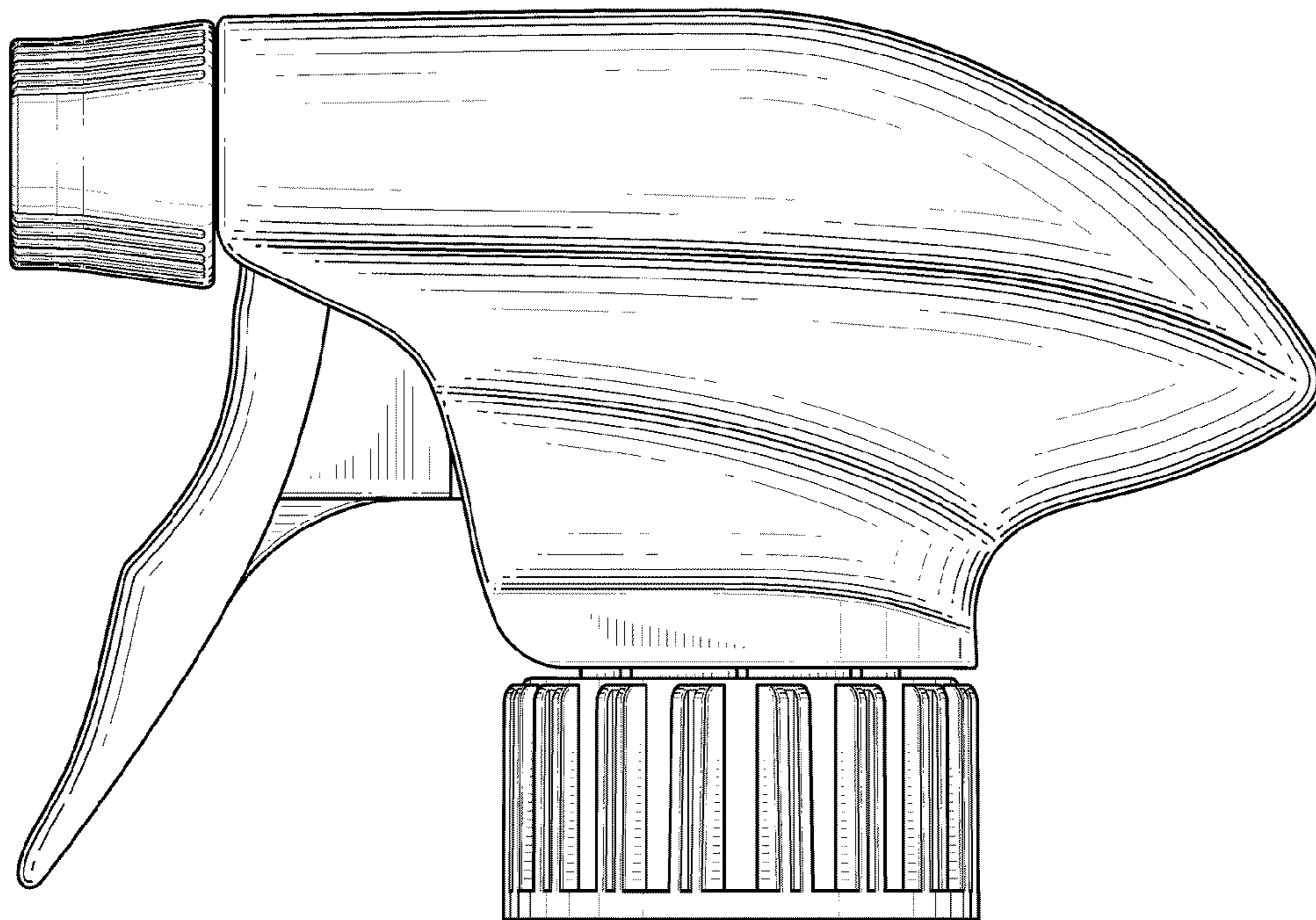

Fig.5.

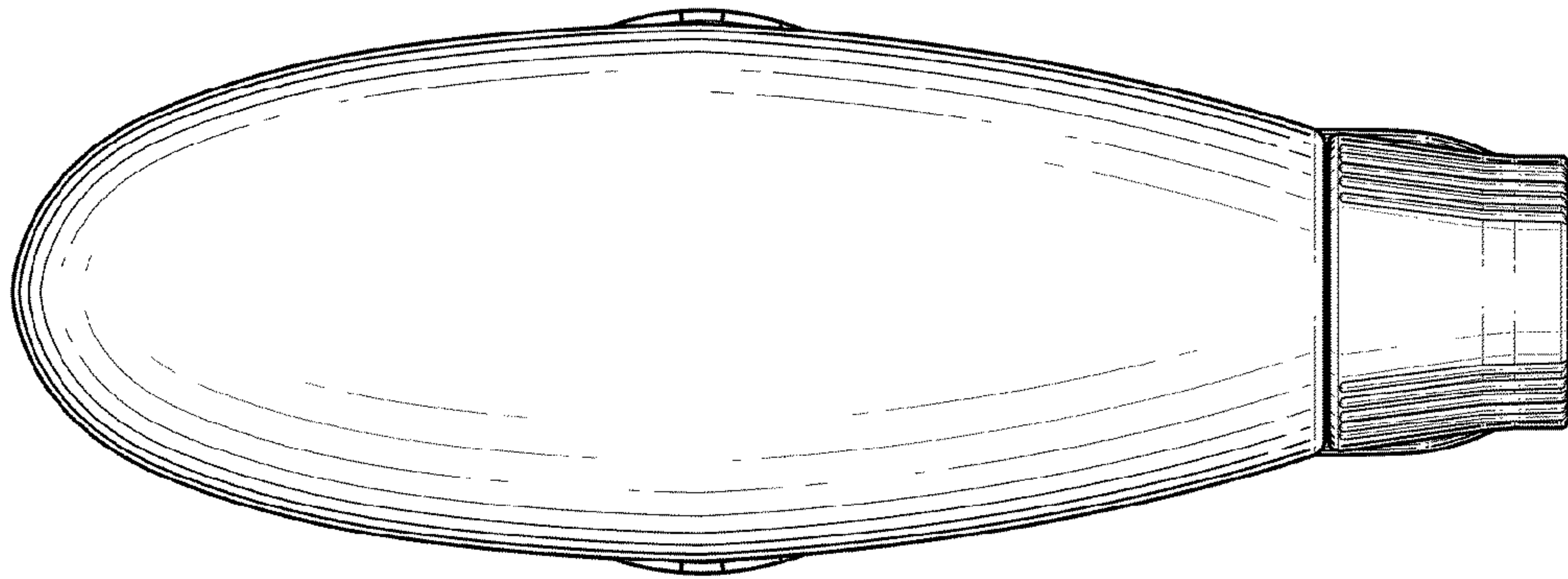

Fig.6.

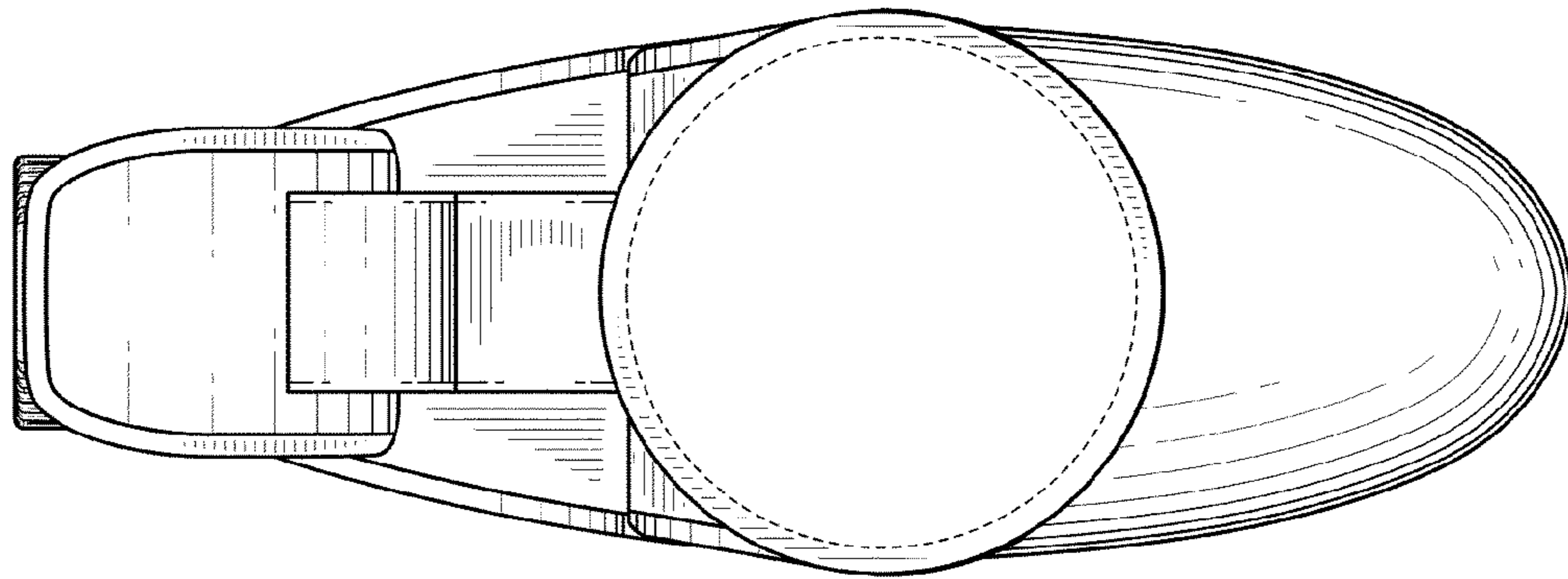

Fig.7.