



US00D582728S

(12) **United States Design Patent**  
**Fite, IV et al.**

(10) **Patent No.:** **US D582,728 S**  
(45) **Date of Patent:** **\*\* Dec. 16, 2008**

(54) **FOLDABLE PLASTIC DISH**

(76) Inventors: **Francis Bartow Fite, IV**, 730 39<sup>th</sup> Ave., Seattle, WA (US) 98122; **Ng Hon Ming**, Rm. 1102, Tung Moon House, Tai Hang Tung Estates, Kowloon, Shek Kip Mei, Hong Kong (CN); **Tang Lai Ho**, Rm. 902, 9/F, Lei Yan House, Lei On Court, Lam Tin, Kowloon, Hong Kong (CN)

3,863,832 A \* 2/1975 Gordon et al. .... 229/125.35  
D261,618 S \* 11/1981 Oliff et al. .... D9/433  
D296,747 S \* 7/1988 Johnson ..... D7/554.3  
5,411,204 A \* 5/1995 DeMay ..... 229/114  
6,079,555 A \* 6/2000 Posson ..... 206/204  
D440,826 S \* 4/2001 Quaintance ..... D7/554.3  
D567,592 S \* 4/2008 Fite et al. .... D7/568

\* cited by examiner

(\*\*) Term: **14 Years**

*Primary Examiner*—Charles A. Rademaker

*Assistant Examiner*—Charles D Hanson

(21) Appl. No.: **29/279,797**

(74) *Attorney, Agent, or Firm*—John R. Benefiel

(22) Filed: **May 8, 2007**

(57) **CLAIM**

**Related U.S. Application Data**

The ornamental design for a foldable plastic dish, as shown and described.

(62) Division of application No. 11/254,237, filed on Oct. 19, 2005.

**DESCRIPTION**

(51) **LOC (8) Cl.** ..... **07-01**

FIG. 1 is a perspective view of a foldable plastic dish showing our new design;

(52) **U.S. Cl.** ..... **D7/587**

FIG. 2 is a bottom view thereof;

(58) **Field of Classification Search** ..... D7/360,

FIG. 3 is a top view thereof;

D7/392.1, 538, 542, 545, 546, 555, 560, 601,

FIG. 4 is a left side view thereof;

D7/602, 543, 548, 552.1–554.4, 584, 586–588,

FIG. 5 is a front view thereof;

D7/394, 585, 565, 571; D9/430, 431, 433,

FIG. 6 is a right side view thereof;

D9/702, 703, 655–657; 220/608, 574; 211/74;

FIG. 7 is a rear view thereof; and,

229/106

FIG. 8 is a plan view thereof; in an unfolded condition.

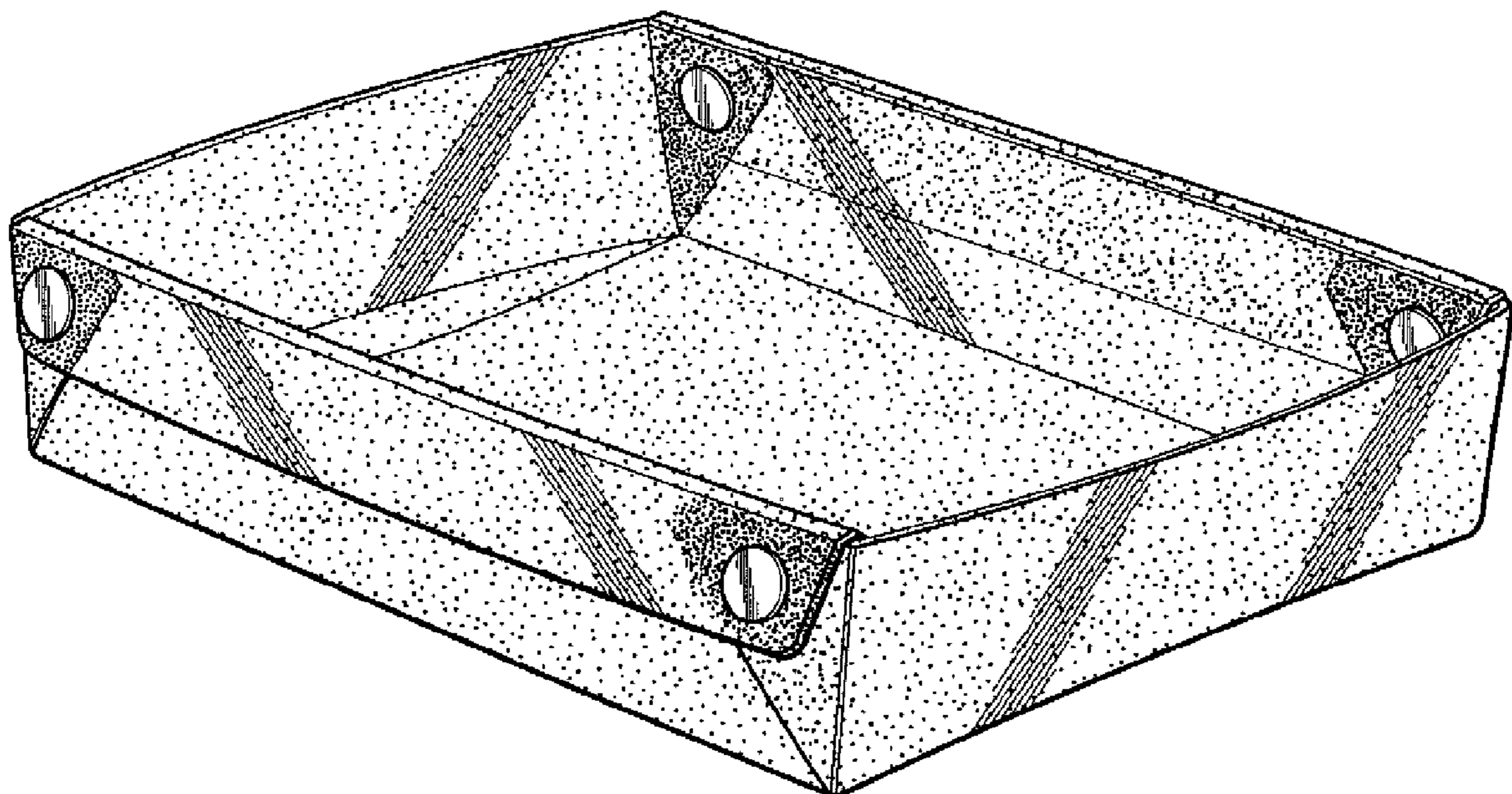
See application file for complete search history.

(56) **References Cited**

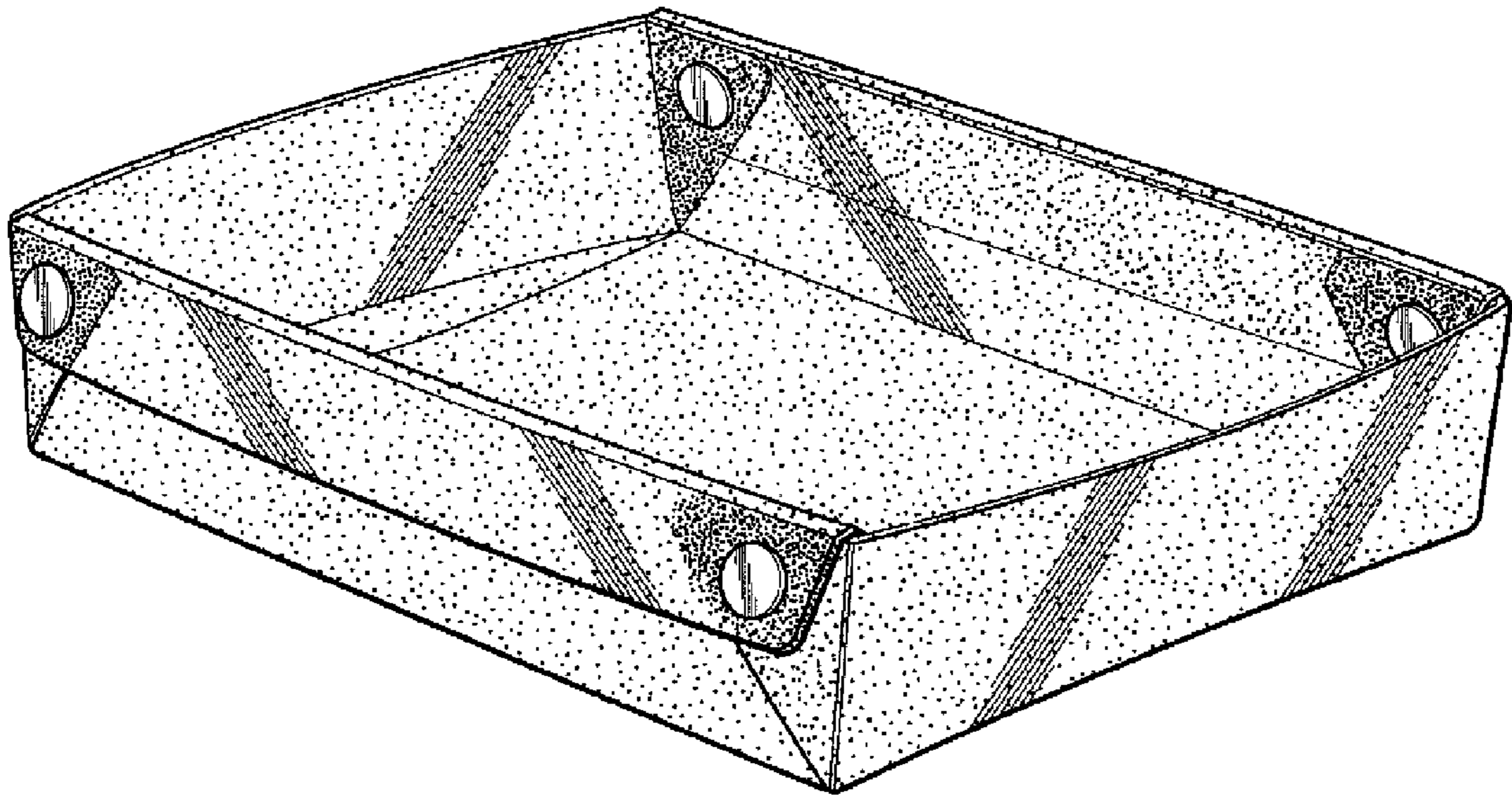
**U.S. PATENT DOCUMENTS**

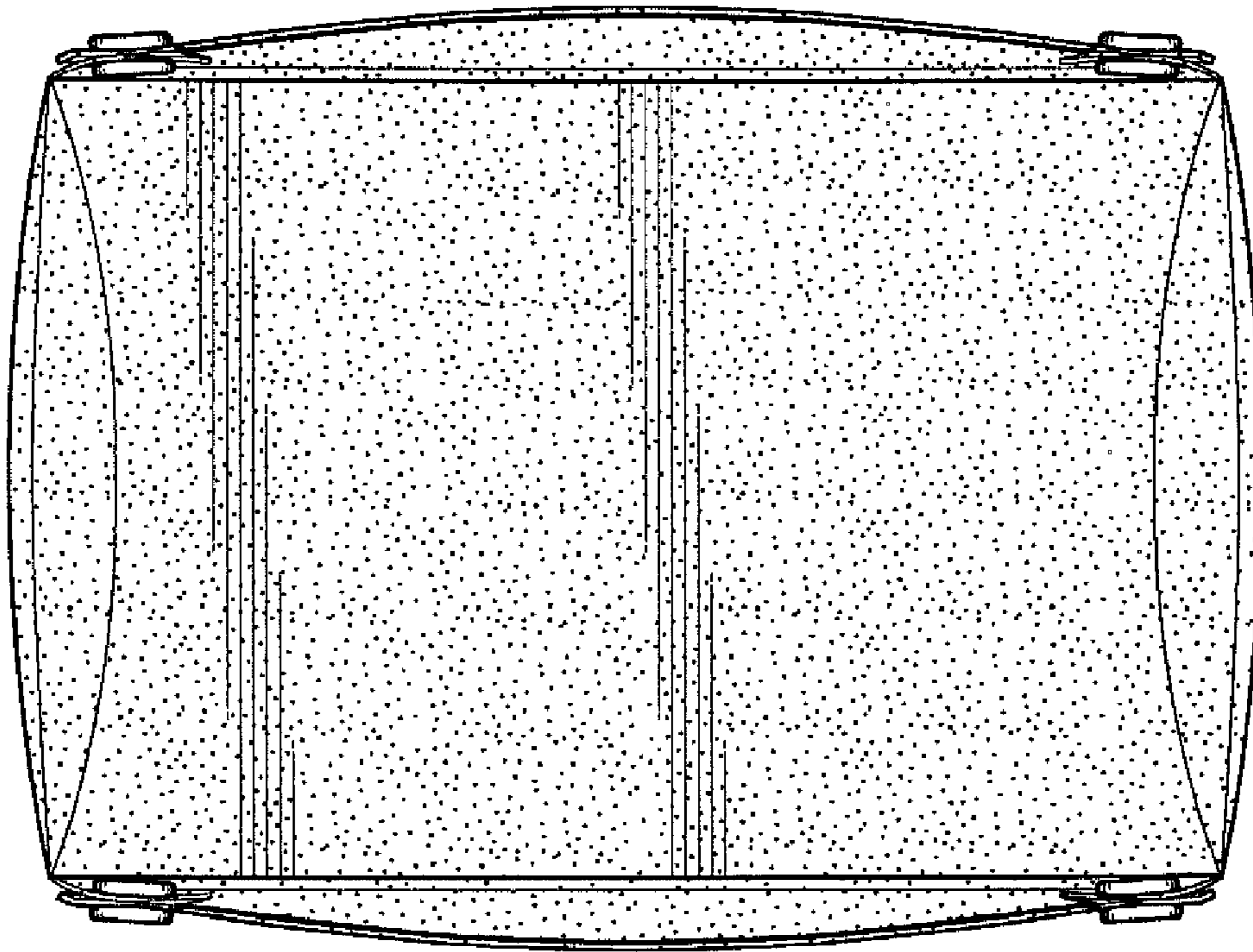
**1 Claim, 5 Drawing Sheets**

3,316,102 A \* 4/1967 Martin et al. .... 426/129

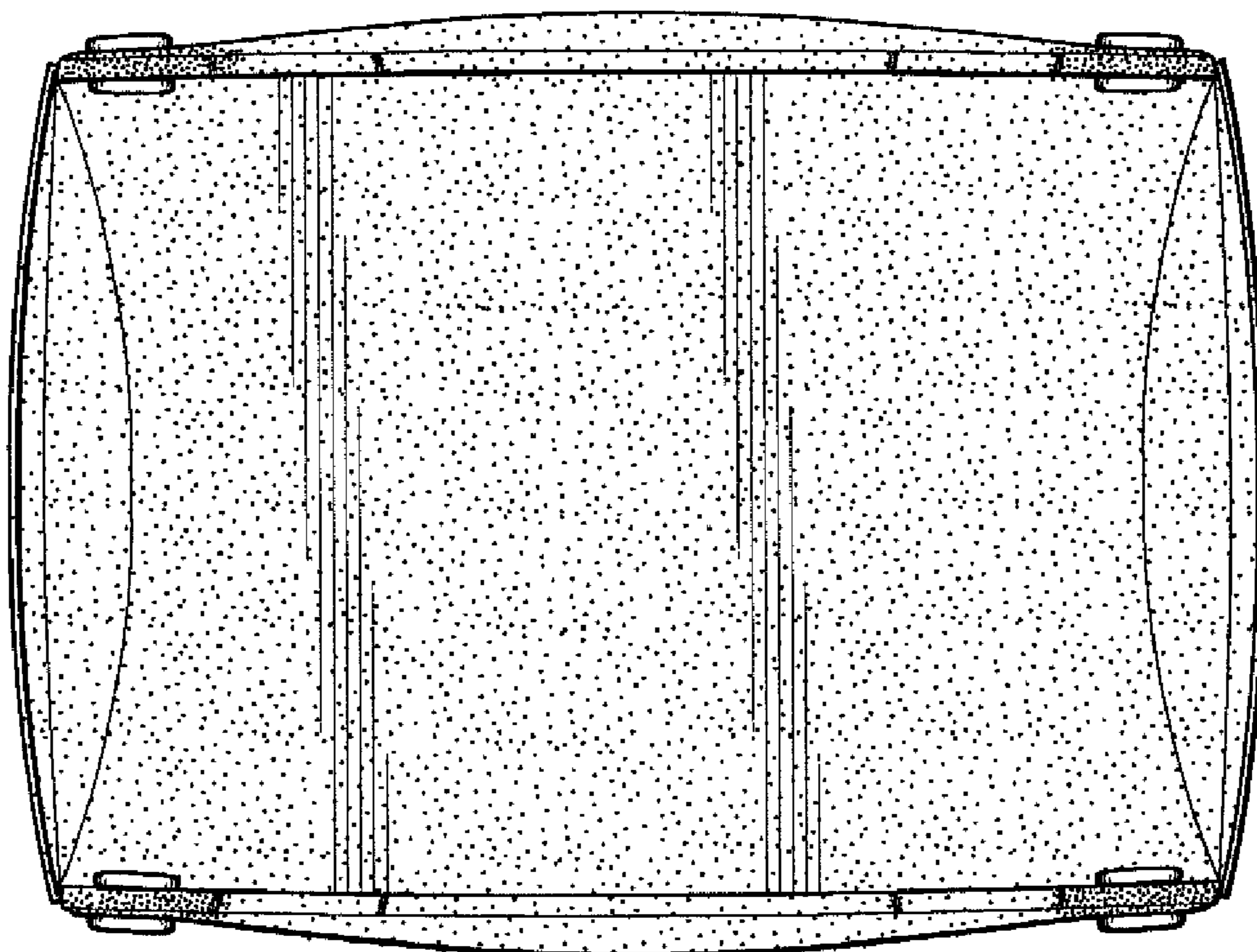


**FIG - 1**

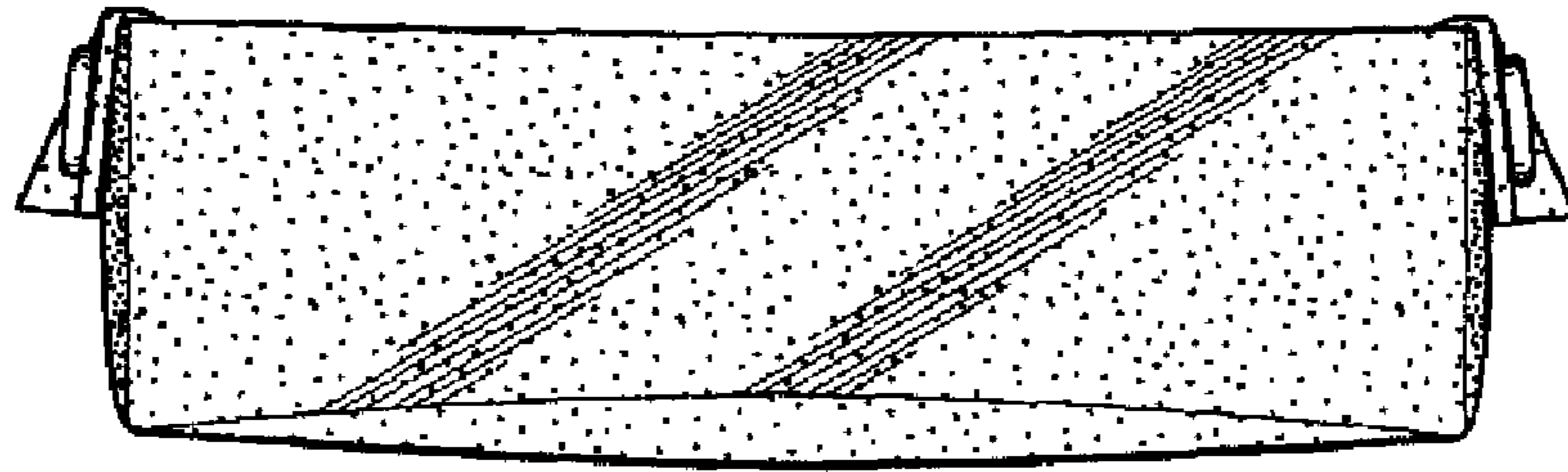




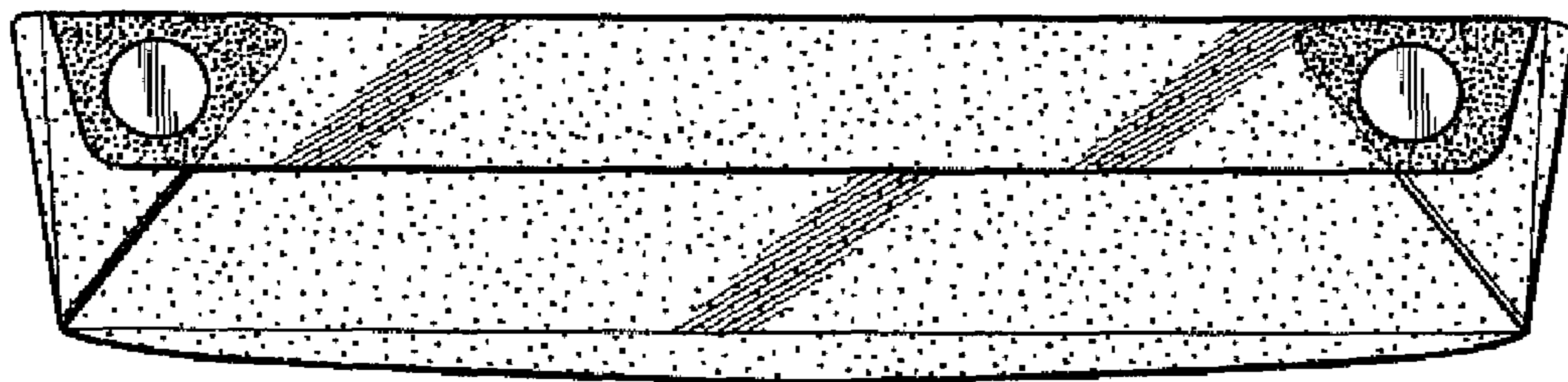
**FIG - 2**



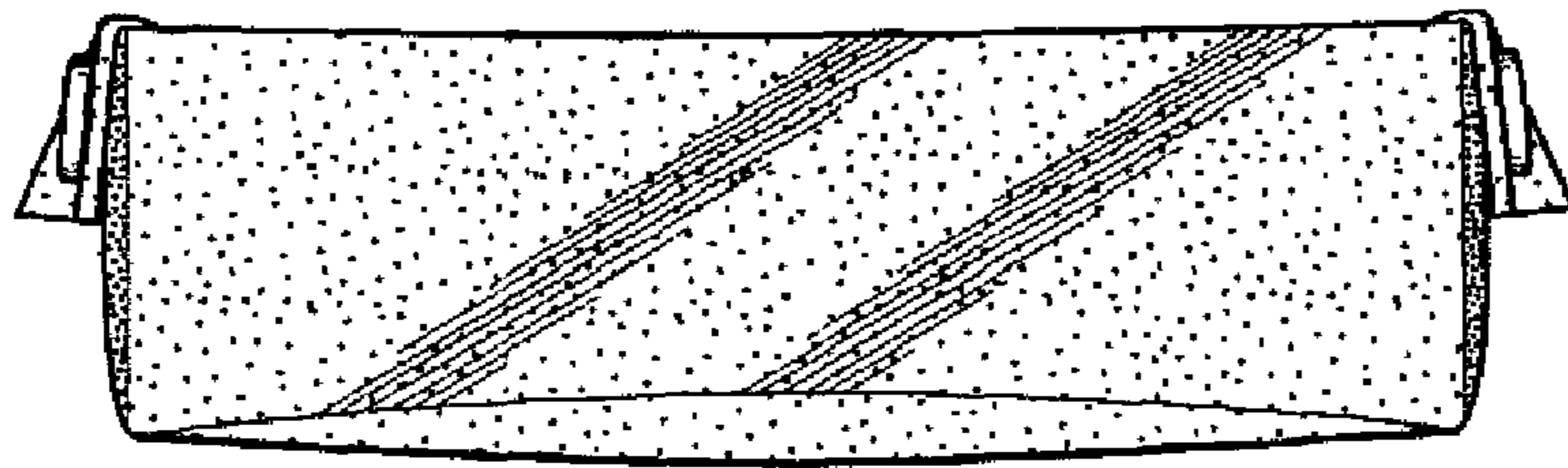
**FIG - 3**



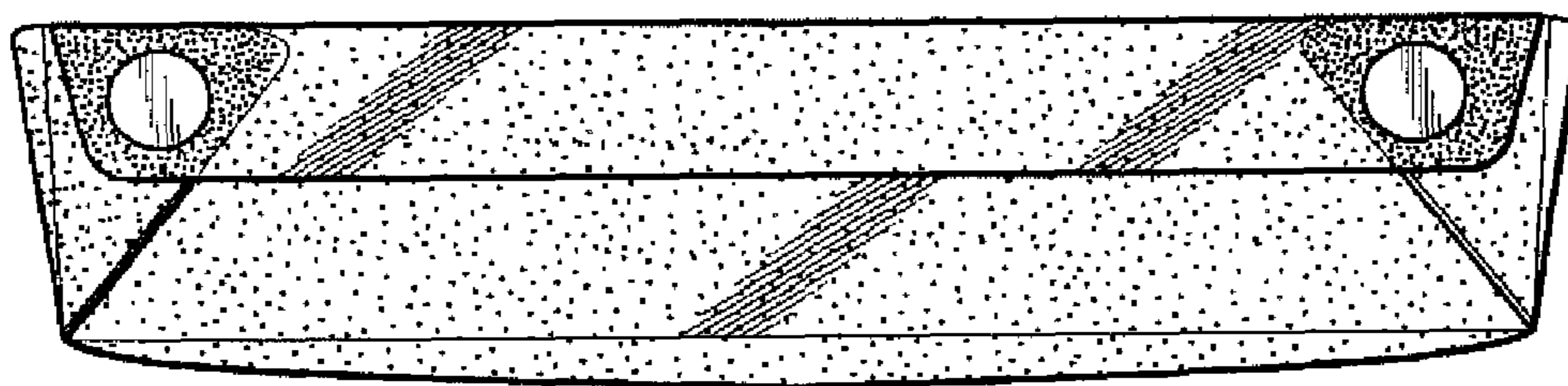
**FIG - 4**



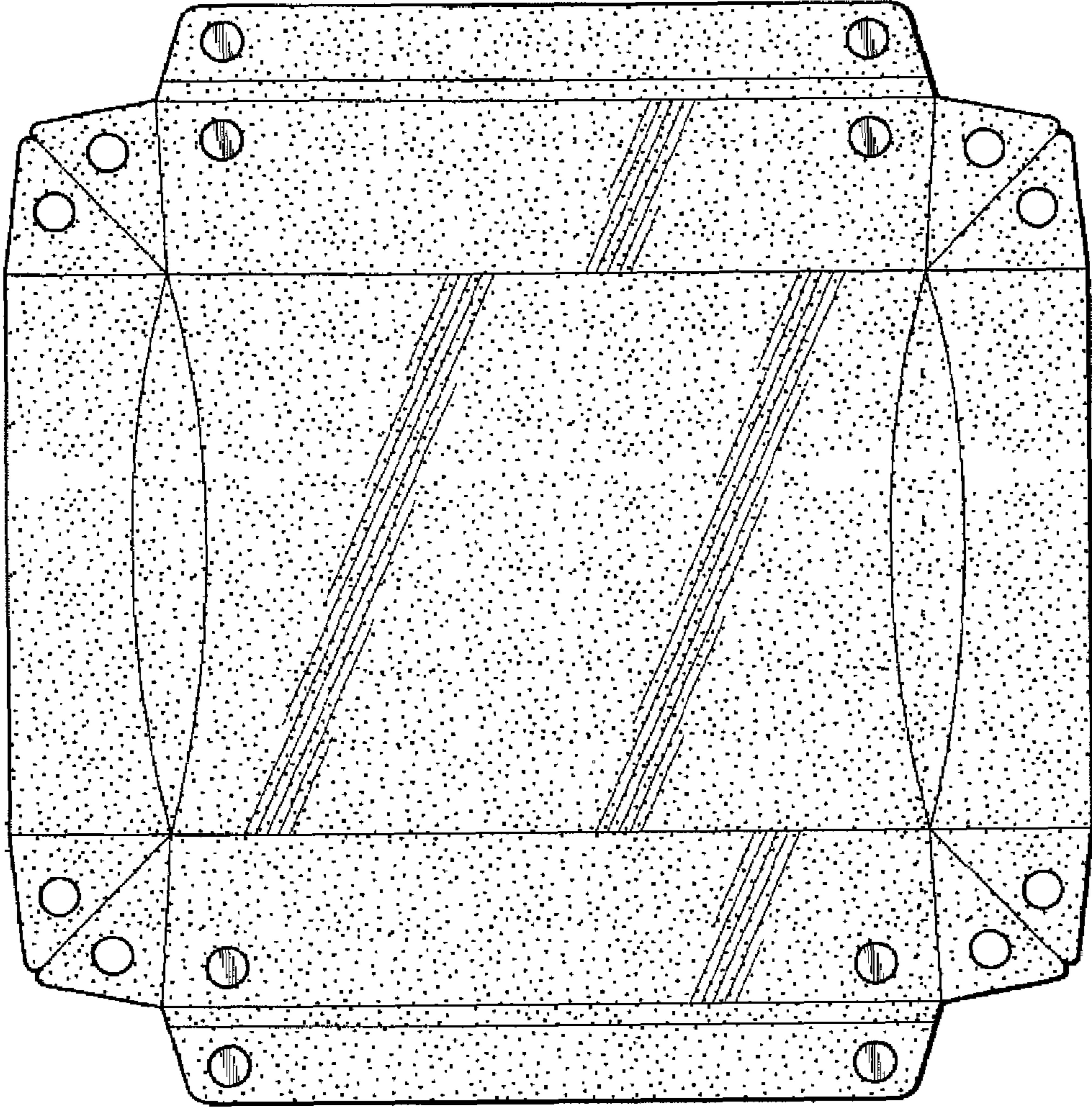
**FIG - 5**



**FIG - 6**



**FIG - 7**



**FIG - 8**