



US00D582673S

(12) **United States Design Patent**
Mangano

(10) **Patent No.:** **US D582,673 S**

(45) **Date of Patent:** **** Dec. 16, 2008**

(54) **VERSATILE AND RECONFIGURABLE LUGGAGE**

5,931,551 A 8/1999 Wang
6,076,641 A 6/2000 Kinzer et al.
6,450,599 B1 9/2002 Mamuyac
6,481,574 B1 11/2002 Pakosh
6,609,598 B2 * 8/2003 Hsu 190/103

(75) Inventor: **Joy Mangano**, St. James, NY (US)

(73) Assignee: **Ingenious Designs LLC**, Edgewood, NY (US)

(Continued)

(**) Term: **14 Years**

Primary Examiner—Philip S Hyder
Assistant Examiner—Roselynn Cody

(21) Appl. No.: **29/265,729**

(74) *Attorney, Agent, or Firm*—Kenyon & Kenyon LLP

(22) Filed: **Sep. 8, 2006**

(57) **CLAIM**

(51) **LOC (8) Cl.** **03-01**

What is claimed is the ornamental design for versatile and reconfigurable luggage, as shown.

(52) **U.S. Cl.** **D3/279; D3/284; D3/902**

(58) **Field of Classification Search** D3/272,
D3/276, 278–279, 283–286, 288–289, 318–319,
D3/31, 902; 190/3–4, 6–7, 13 R, 14, 18 A,
190/18 R, 100, 103, 109–112, 115, 119, 903
See application file for complete search history.

DESCRIPTION

(56) **References Cited**

U.S. PATENT DOCUMENTS

823,700 A	6/1906	Sayer, Jr.	
923,807 A	6/1909	Bonsall	
944,593 A	12/1909	Bonsall	
1,057,195 A	3/1913	Wheary	
1,106,581 A *	8/1914	Peppard	190/4
1,314,556 A	9/1919	Wheary	
1,694,470 A	12/1928	Hursh	
1,702,052 A *	2/1929	McCutcheon	190/13 R
1,728,212 A	9/1929	McCollum	
D82,596 S *	11/1930	Apter	D3/272
D82,782 S *	12/1930	Apter	D3/272
1,818,525 A *	8/1931	Perez	190/3
2,244,887 A	6/1941	Manley	
2,533,333 A	12/1950	Kitson	
3,861,504 A	1/1975	McGraw	
3,869,034 A	3/1975	Thornton, Jr.	
4,738,340 A	4/1988	Crespi	
5,096,030 A	3/1992	Espinosa et al.	
5,628,397 A	5/1997	Ham	
5,671,831 A *	9/1997	Chiu	190/103
5,896,962 A	4/1999	Smith et al.	

FIG. 1 is a front view of the versatile and reconfigurable luggage in an open configuration;

FIG. 2 is a back view thereof;

FIG. 3 is a right perspective view thereof;

FIG. 4 is a left perspective view thereof;

FIG. 5 is a front view of the versatile and reconfigurable luggage in a closed configuration;

FIG. 6 is a right side view of the versatile and reconfigurable luggage in a closed configuration;

FIG. 7 is a back view of the versatile and reconfigurable luggage in a closed configuration; and,

FIG. 8 is a left side view of the versatile and reconfigurable luggage in a closed configuration.

Referring to FIG. 1, the dashed lines located on the left-hand side of the versatile and reconfigurable luggage denote unclaimed subject matter, while the dashed lines on the right-hand side thereof represent stitching. Referring to FIGS. 2–4 and 6–8, the smaller dashed lines represent unclaimed subject matter, while the larger dashed lines represent stitching. The dashed lines denoting unclaimed subject matter are directed to environment.

1 Claim, 8 Drawing Sheets

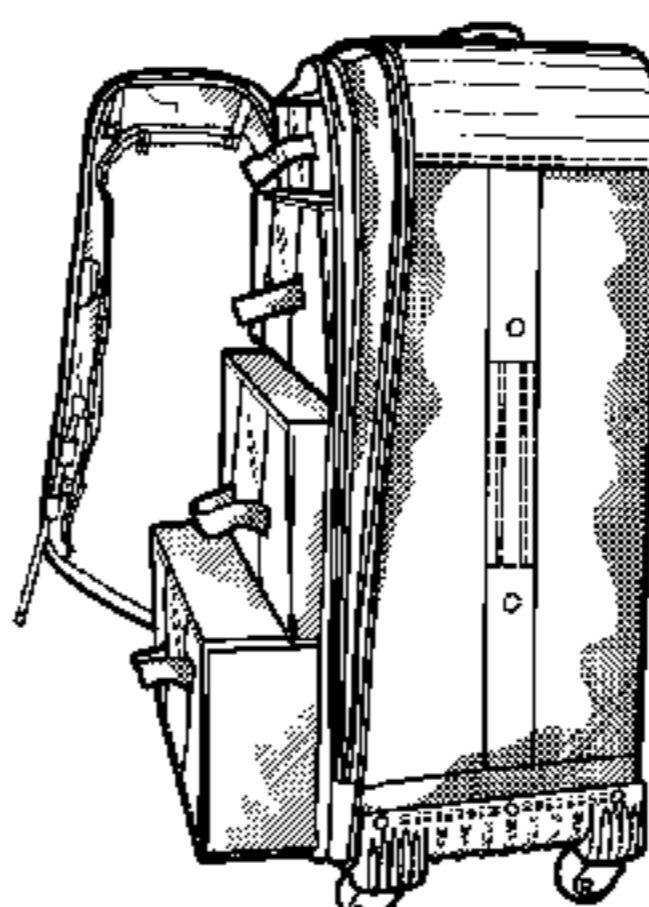
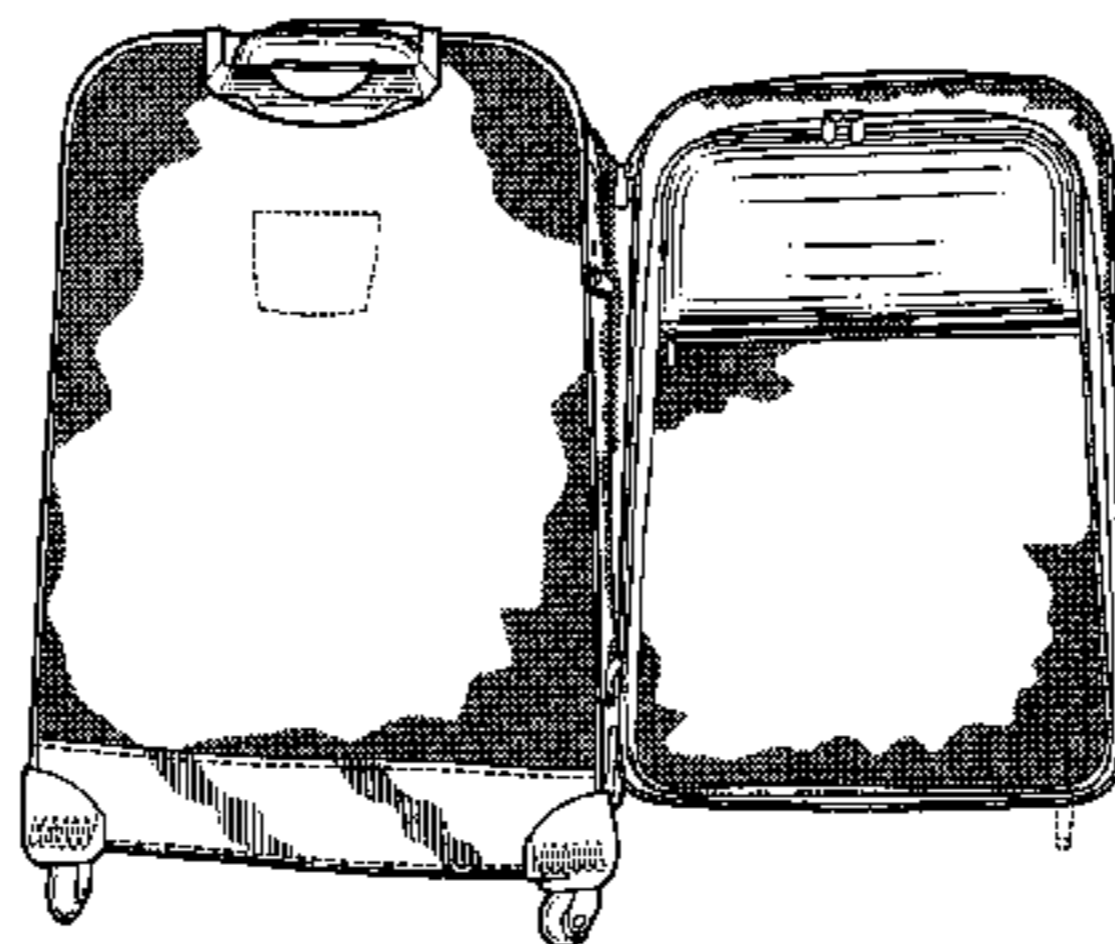

US D582,673 S

Page 2

U.S. PATENT DOCUMENTS

D501,601 S	2/2005	Platte, III			
D507,876 S *	8/2005	Fadely	D3/279		
6,923,516 B2	8/2005	Sheng-Bin			
D515,813 S	2/2006	Roberson			
D554,862 S *	11/2007	Hsieh	D3/279		
2004/0003975 A1 *	1/2004	Dulin	190/110		
2005/0029911 A1	2/2005	Sheng-Bin			
				2005/0098403 A1	5/2005 McIntyre
				2005/0126872 A1	6/2005 Dror
				2005/0145458 A1	7/2005 Cohen
				2006/0096821 A1	5/2006 McKaba
				2007/0089954 A1 *	4/2007 Eardley et al. 190/110
				2007/0151820 A1 *	7/2007 Lin et al. 190/103
				2007/0267262 A1 *	11/2007 Sederoff

* cited by examiner

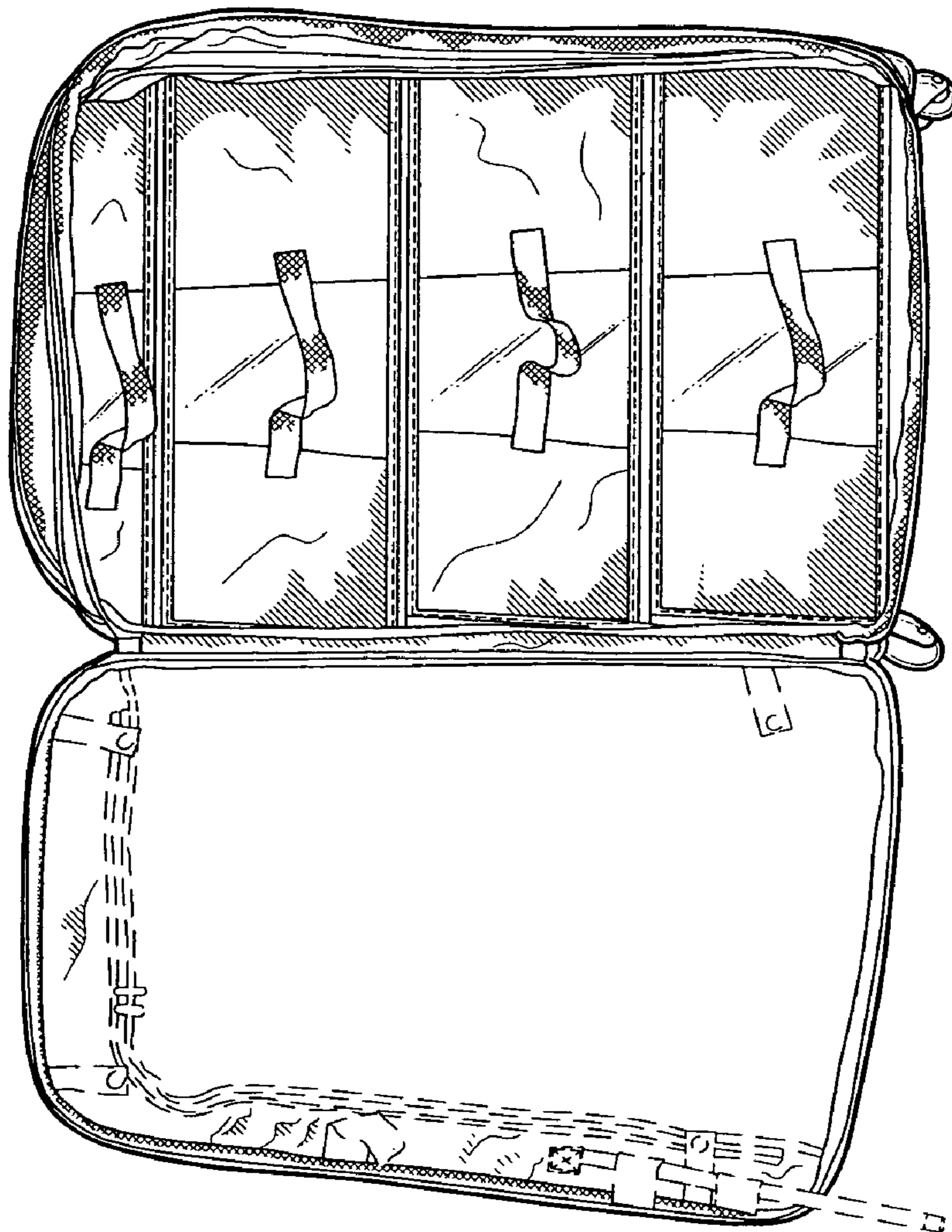

FIG. 1

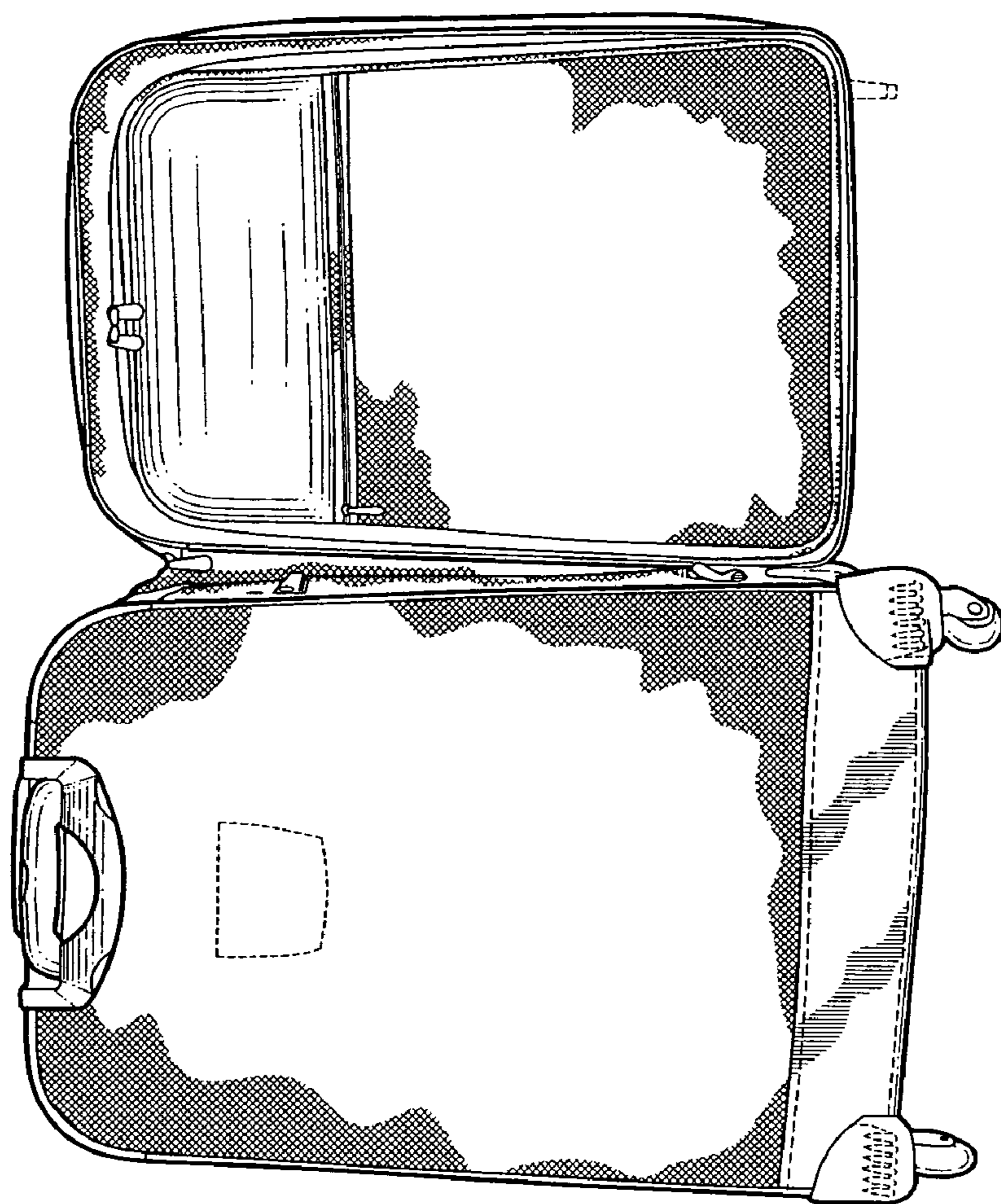

FIG. 2

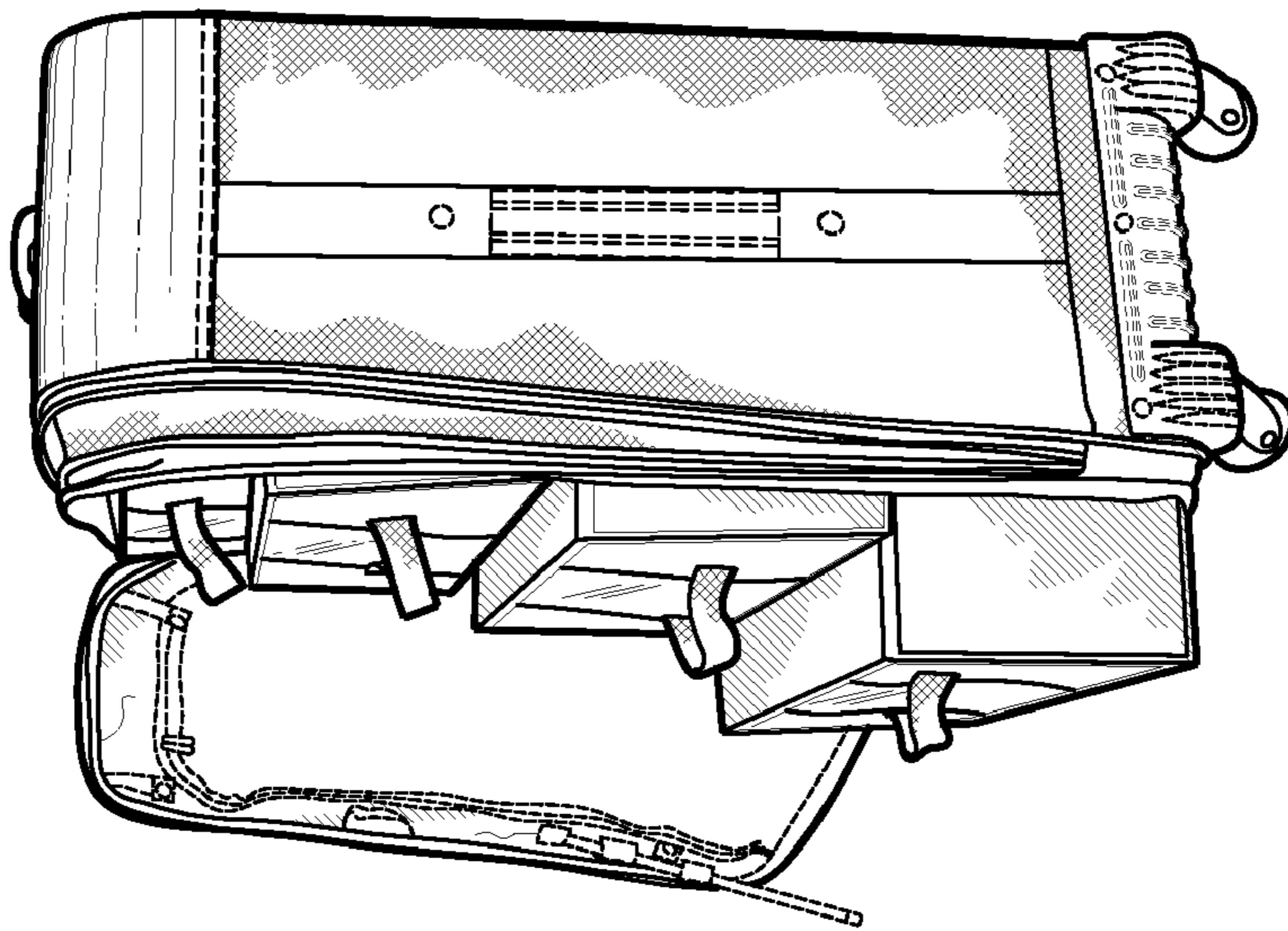

FIG. 3

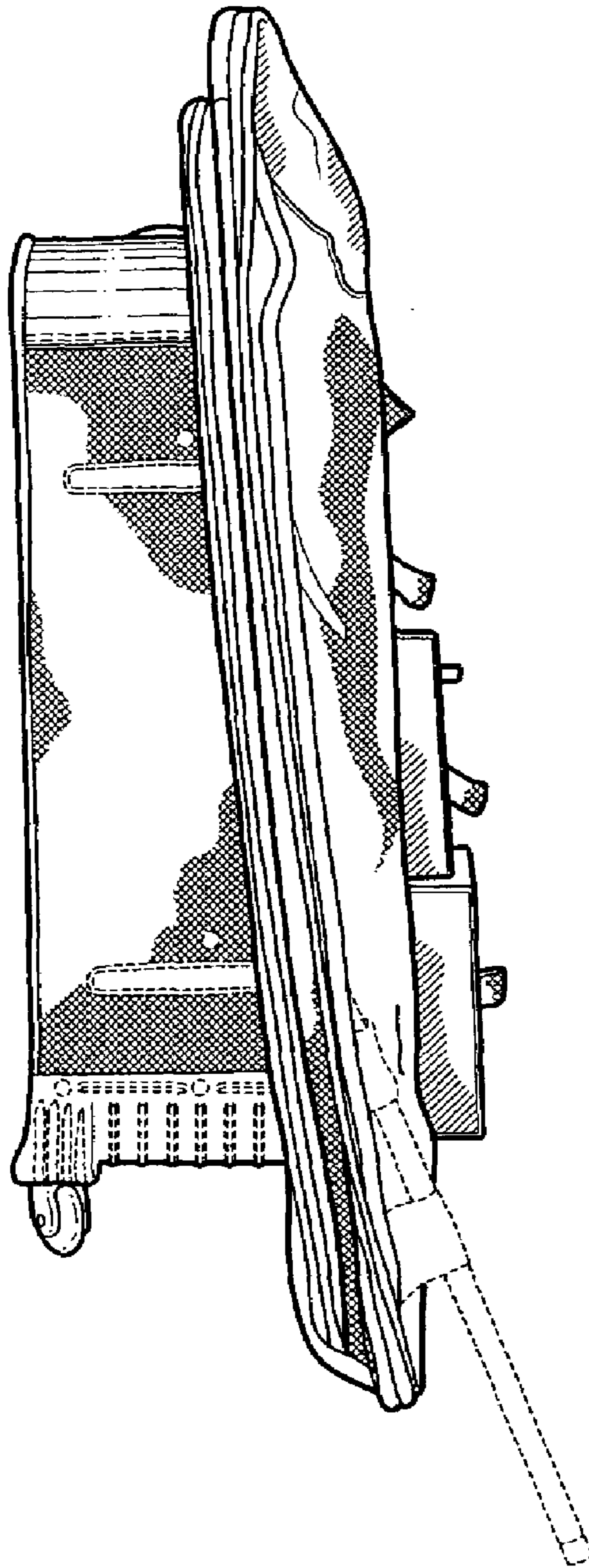

FIG. 4

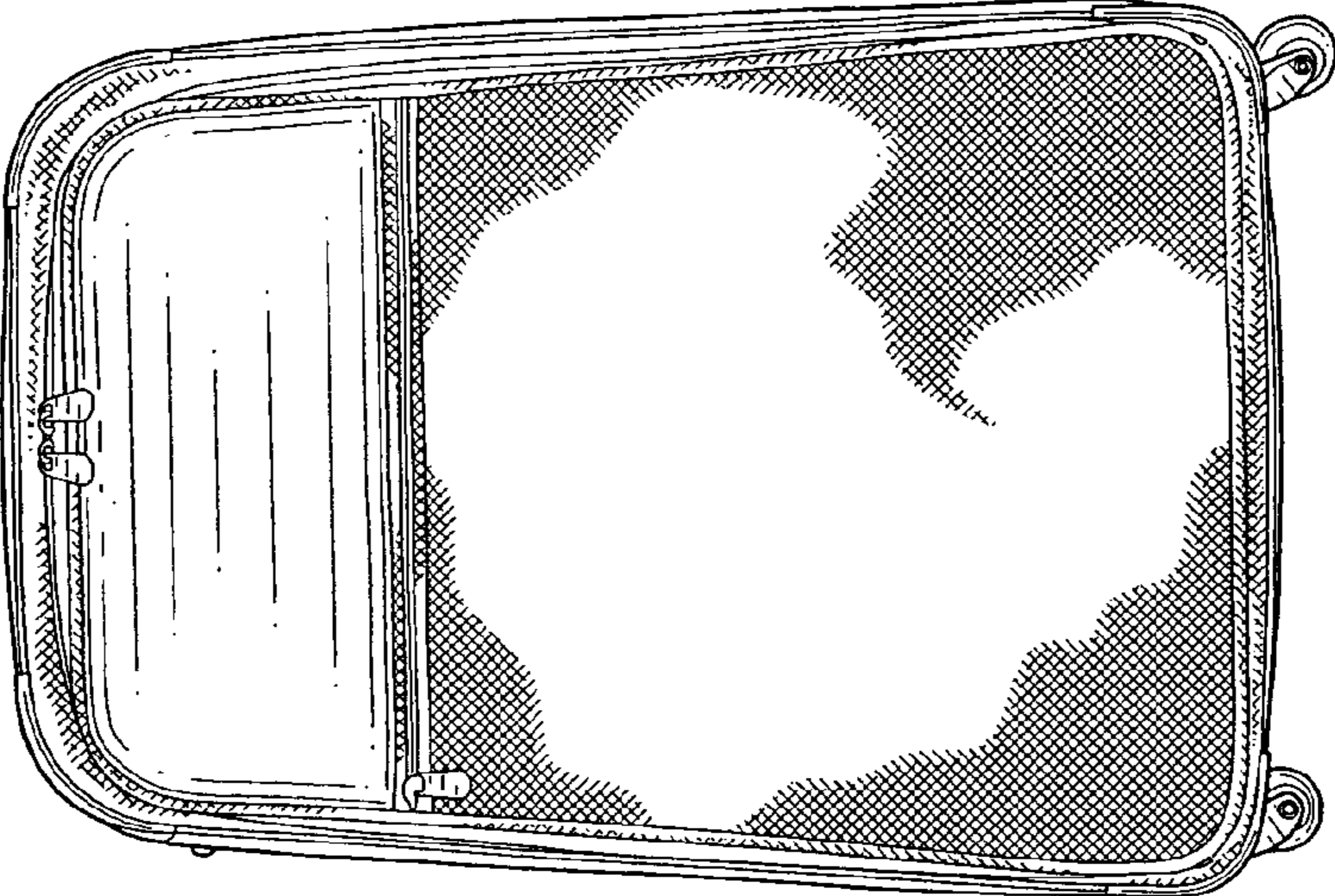

FIG. 5

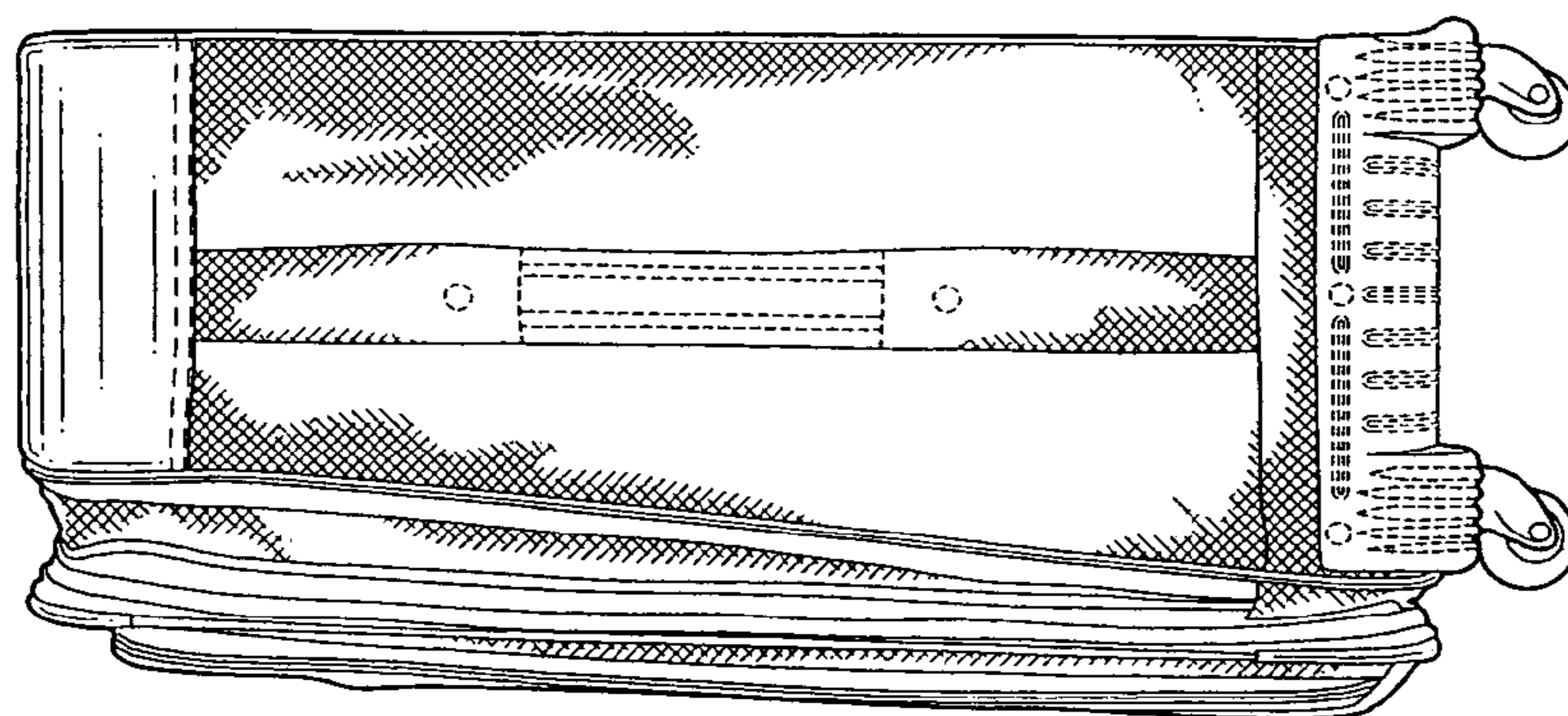

FIG. 6

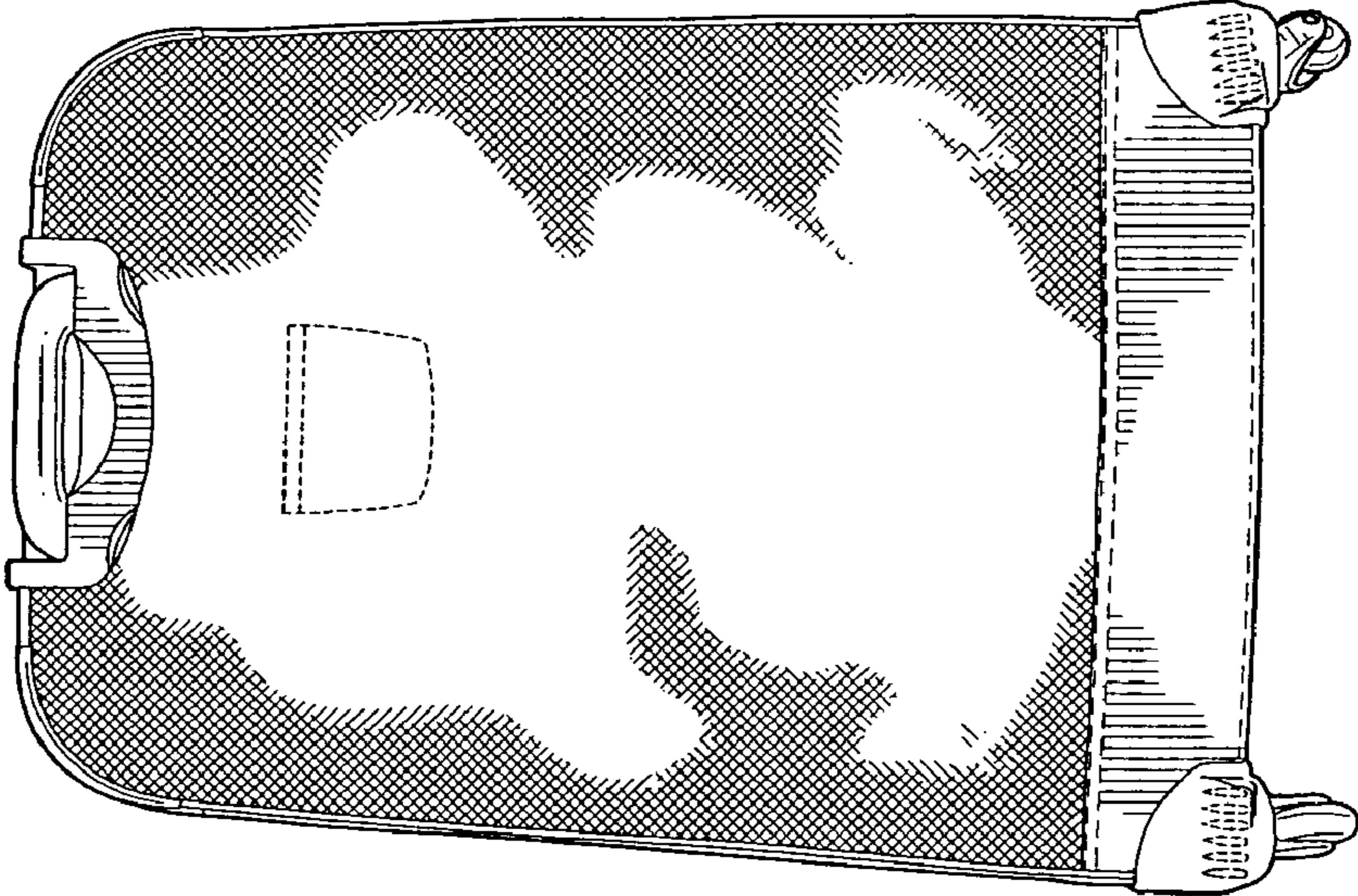

FIG. 7

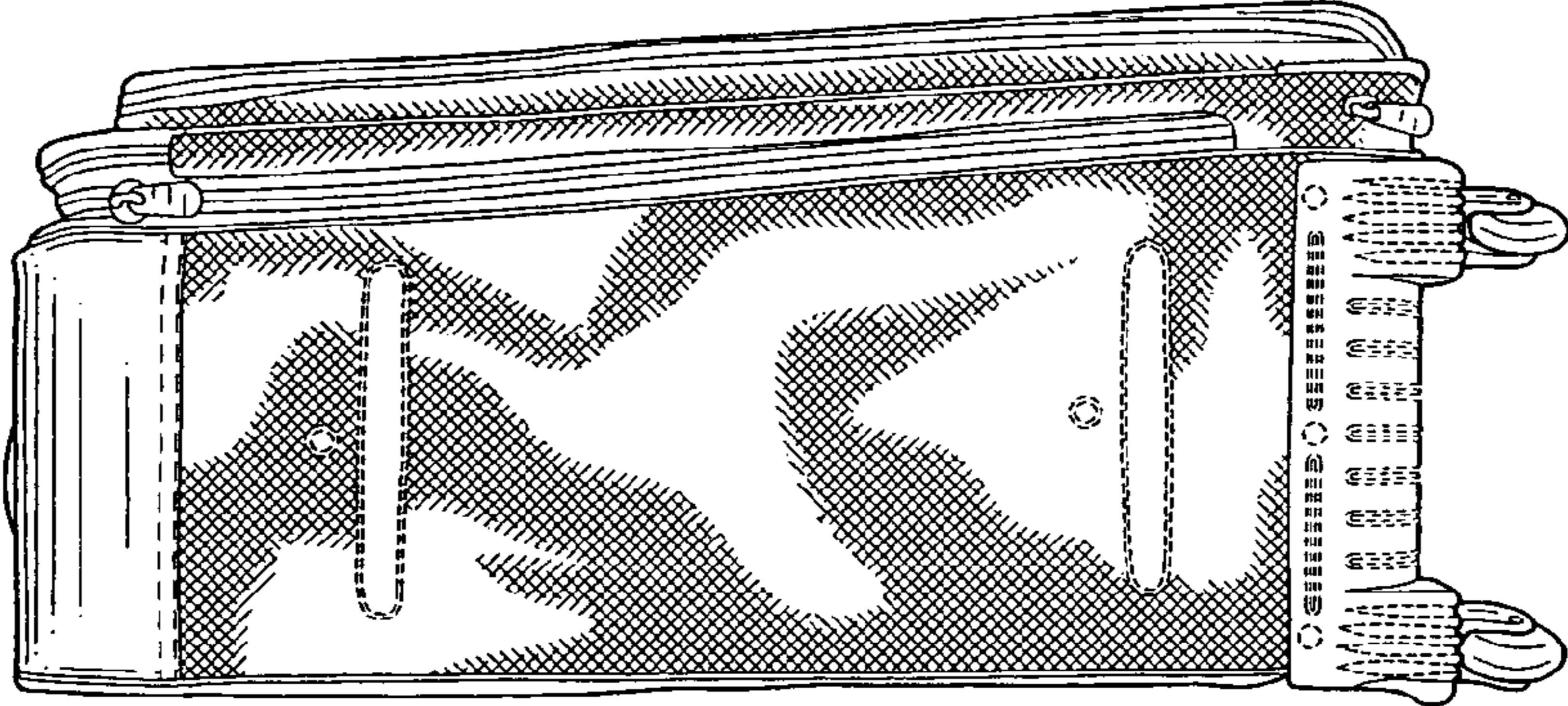

FIG.8