



US00D582669S

(12) **United States Design Patent**  
**Javits, Jr.**

(10) **Patent No.:** **US D582,669 S**  
(45) **Date of Patent:** **\*\* Dec. 16, 2008**

(54) **HANDBAG**

(75) Inventor: **Eric M. Javits, Jr.**, New York, NY (US)

(73) Assignee: **JAV-JR LLC**, Long Island City, NY (US)

(\*\*) Term: **14 Years**

(21) Appl. No.: **29/303,960**

(22) Filed: **Feb. 21, 2008**

(51) **LOC (8) Cl.** ..... **03-01**

(52) **U.S. Cl.** ..... **D3/243**

(58) **Field of Classification Search** ..... D3/232-233,  
D3/240-246, 318, 322, 324; 150/100, 103-104,  
150/107-110, 114, 118-119

See application file for complete search history.

(56) **References Cited**

**U.S. PATENT DOCUMENTS**

D94,871 S *	3/1935	Cesario	.....	D3/243
D324,451 S *	3/1992	Dixsaut	.....	D3/243
D507,873 S *	8/2005	Hanley	.....	D3/243
D523,241 S *	6/2006	Gonzalez	.....	D3/243
D545,059 S *	6/2007	Gerbi	.....	D3/246

\* cited by examiner

*Primary Examiner*—Holly H Baynham

(74) *Attorney, Agent, or Firm*—Alston & Bird LLP

(57) **CLAIM**

The ornamental design for handbag, as shown and described.

**DESCRIPTION**

FIG. 1 is a perspective view of handbag showing my new design;

FIG. 2 is a front elevation view thereof;

FIG. 3 is a rear elevation view thereof;

FIG. 4 is a top plan view thereof;

FIG. 5 is a bottom plan view thereof;

FIG. 6 is a right side elevation view thereof;

FIG. 7 is a left side elevation view thereof;

FIG. 8 is another perspective view thereof shown in an open configuration;

FIG. 9 is another top plan view thereof shown in an open configuration; and,

FIG. 10 is a right side elevation view thereof shown in an open configuration.

The broken lines shown herein are for illustrative purposes only and form no part of the claimed design.

**1 Claim, 9 Drawing Sheets**

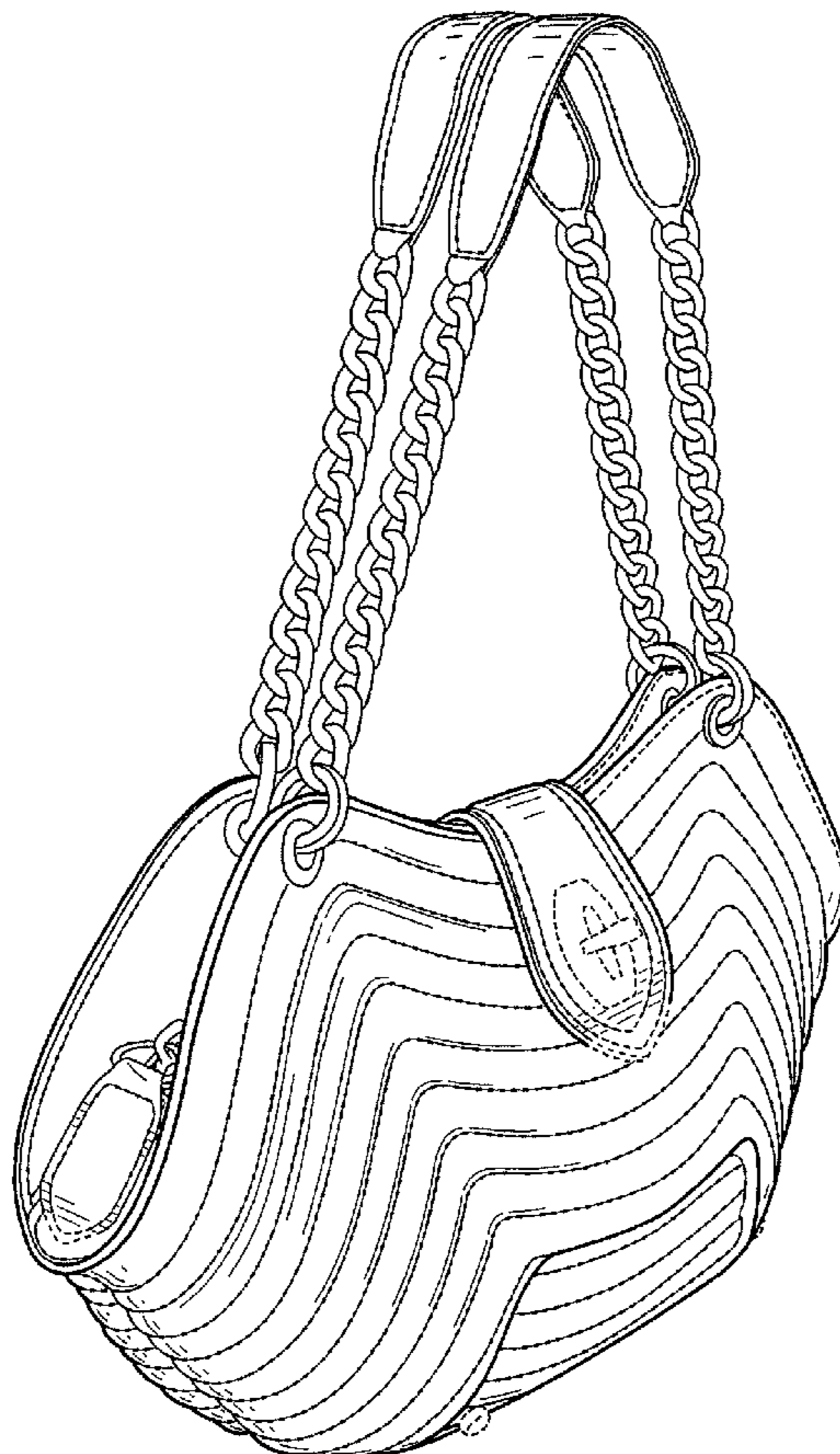

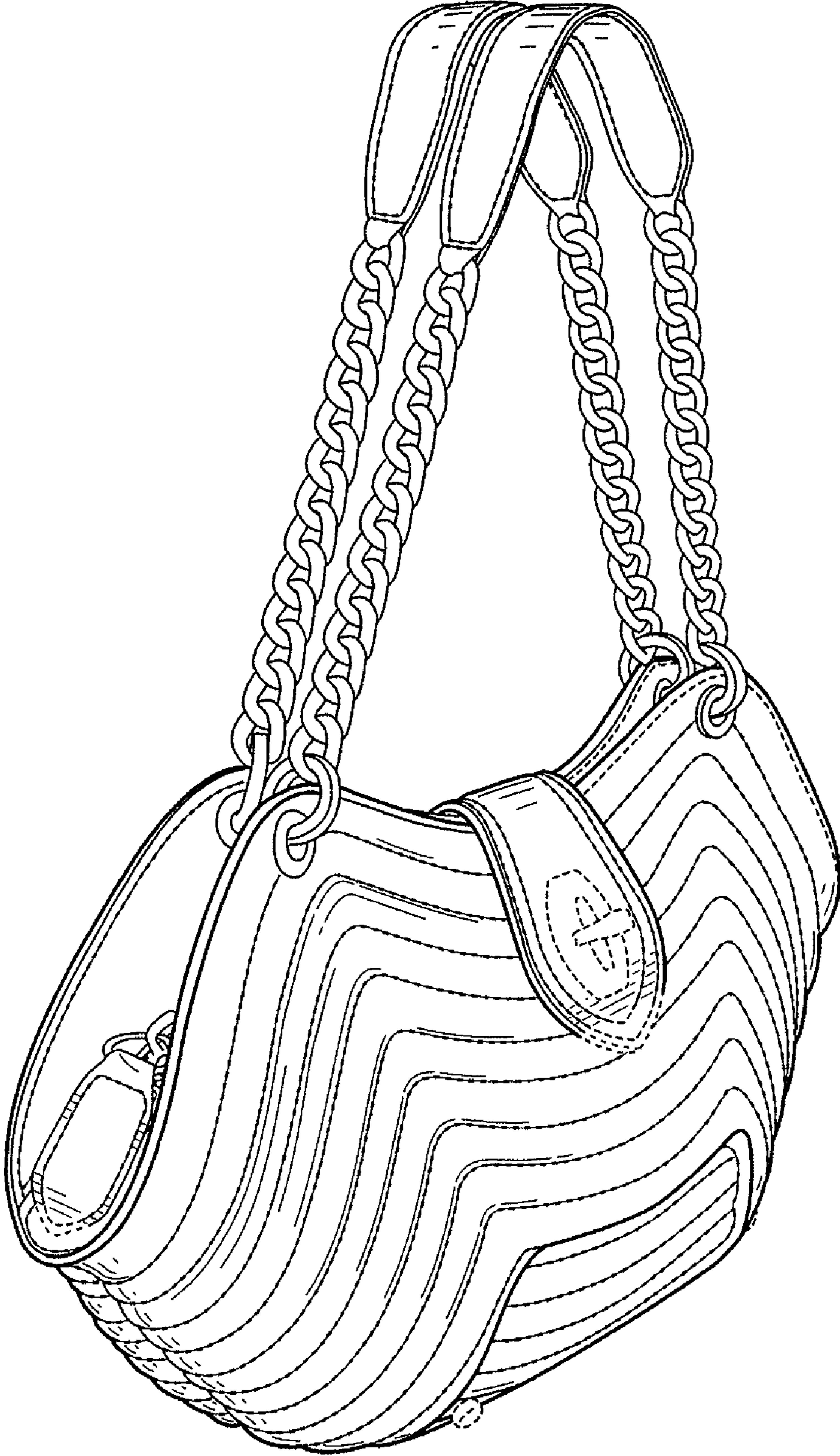

FIG. 1



FIG. 2





FIG. 3

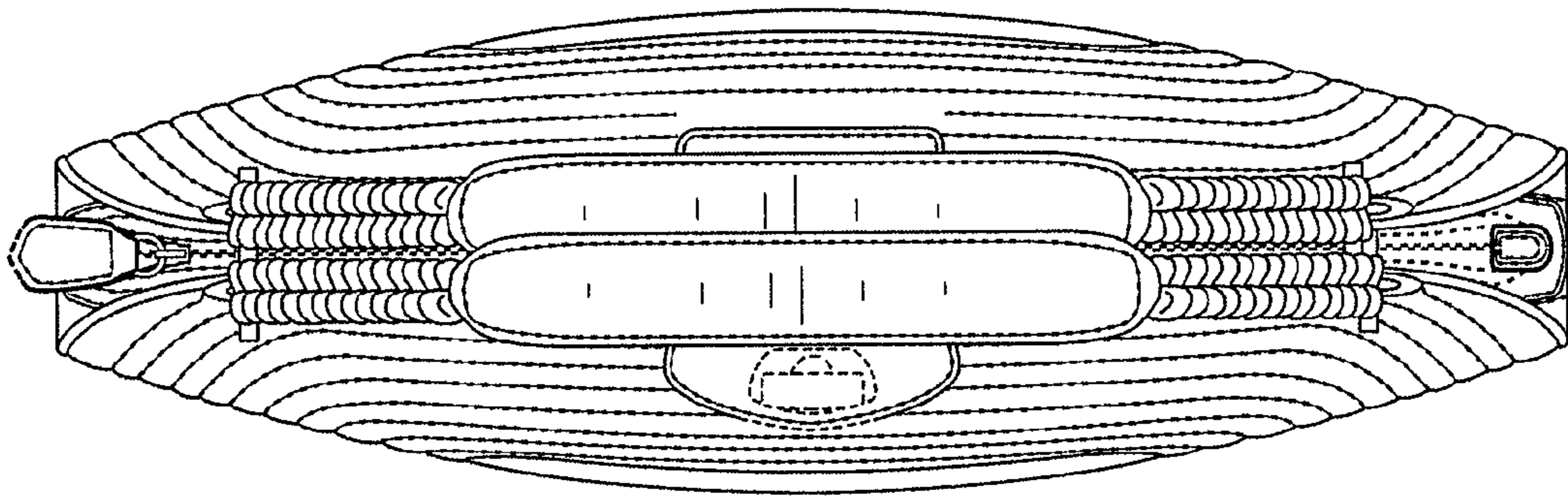

FIG. 4

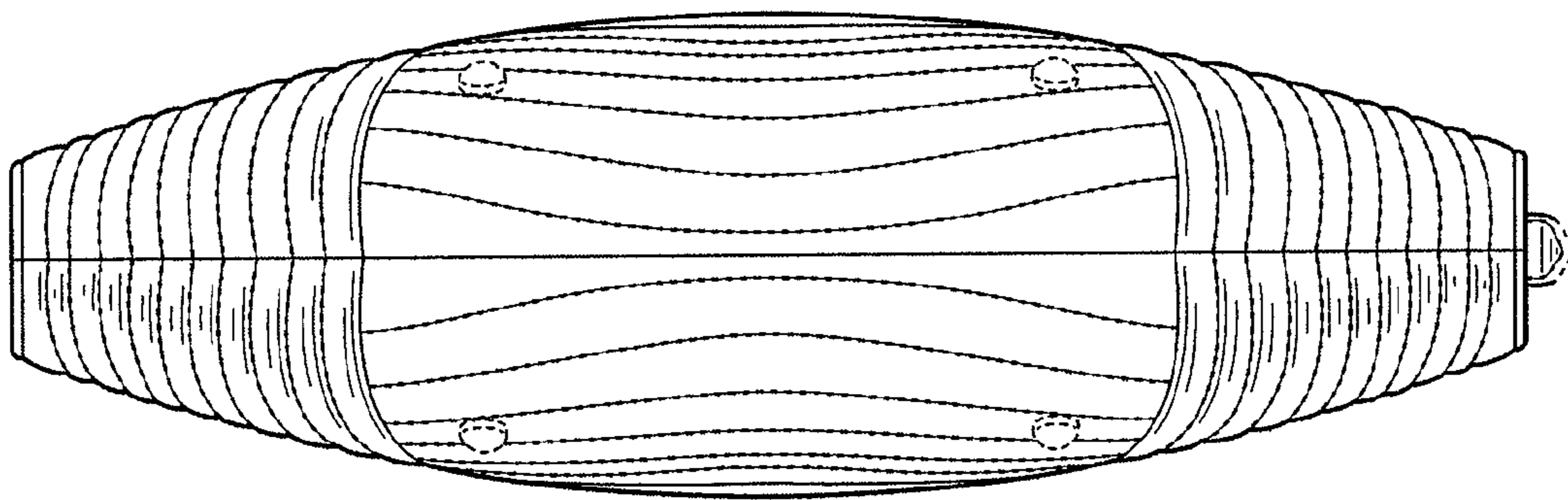

FIG. 5

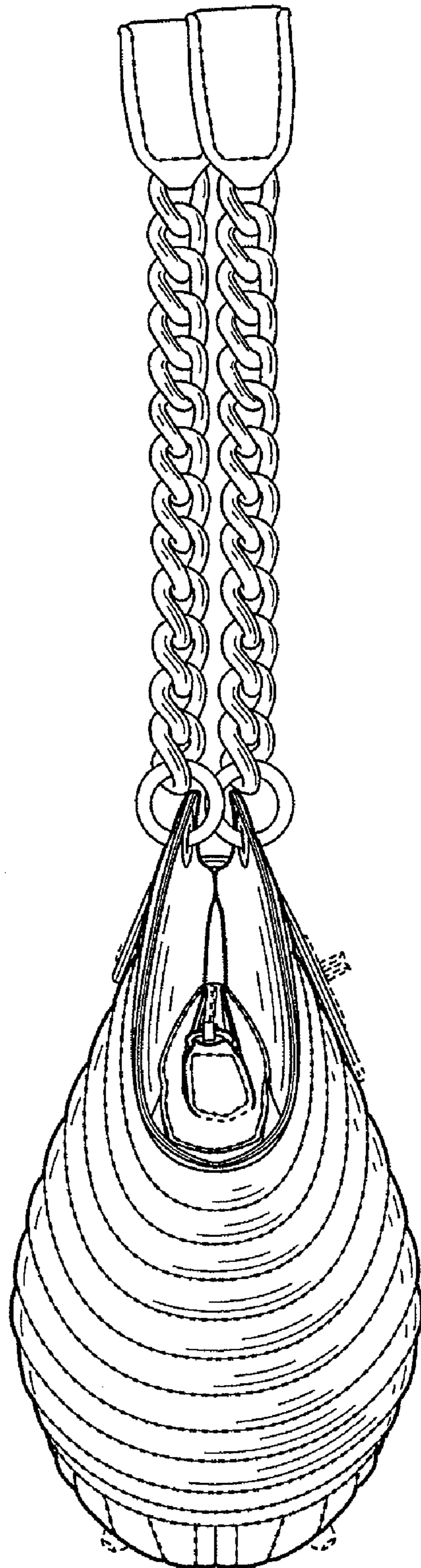

FIG. 6

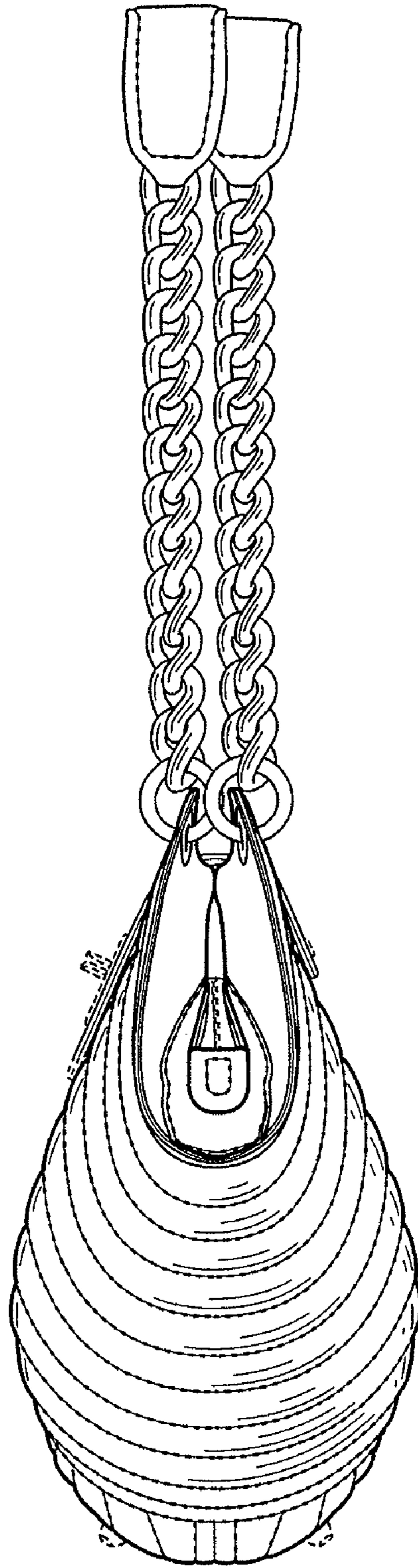

FIG. 7



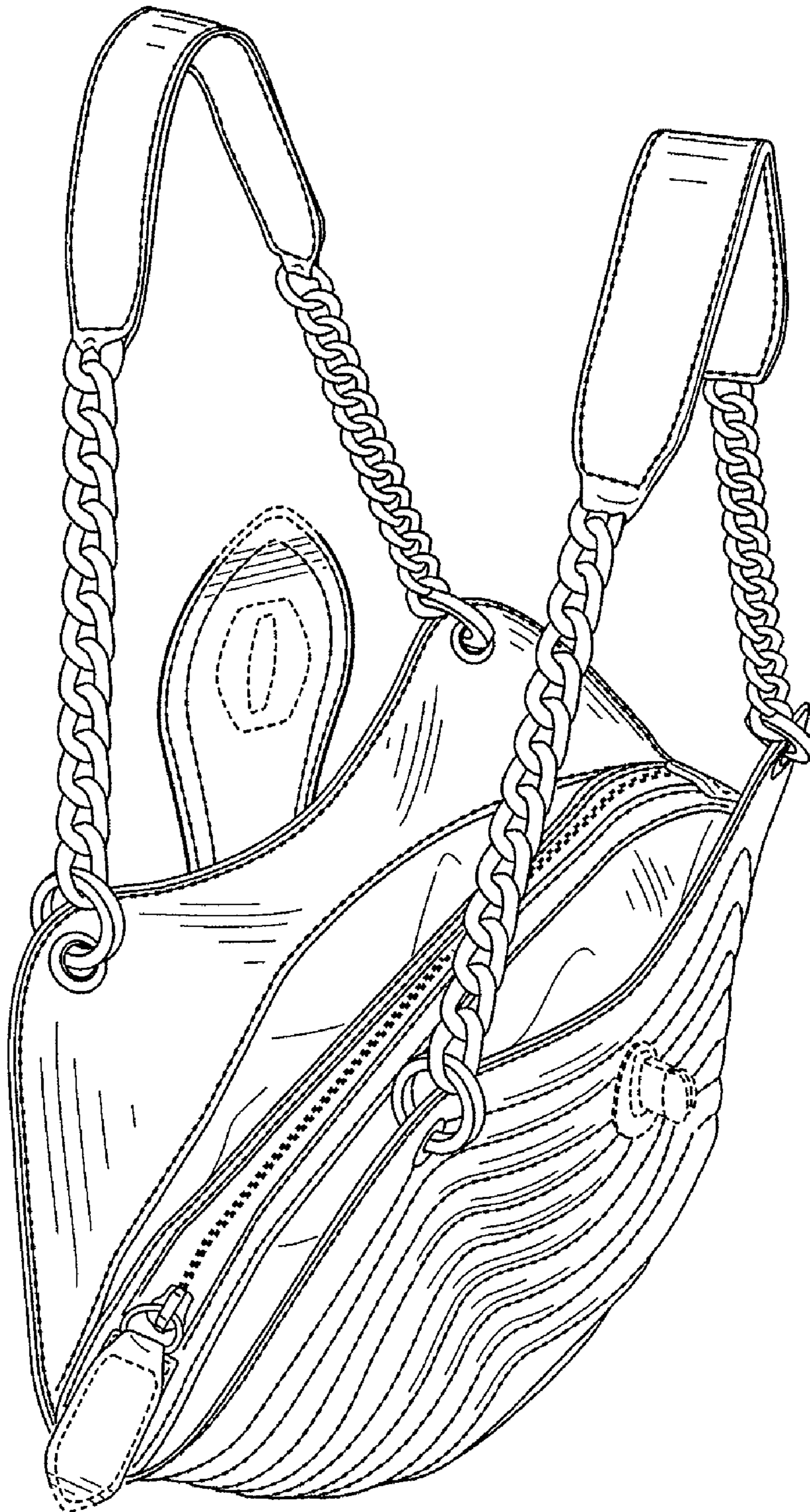

FIG. 8



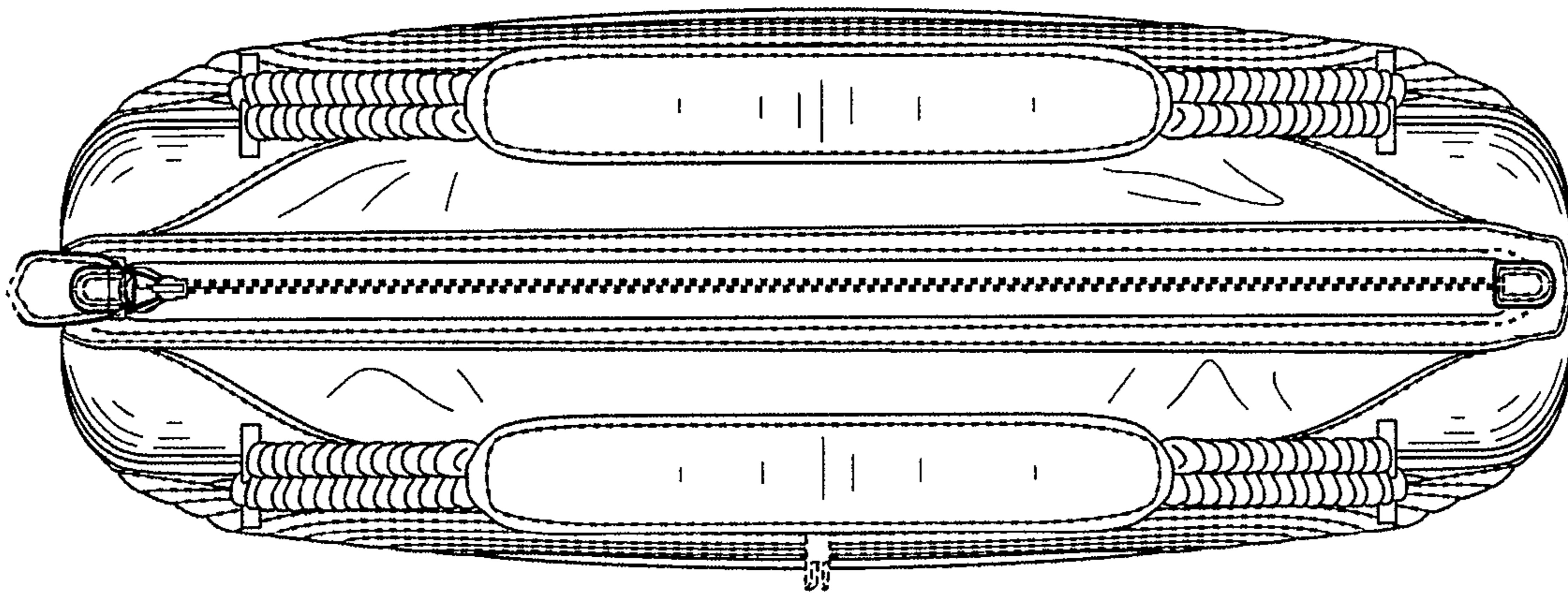

FIG. 9

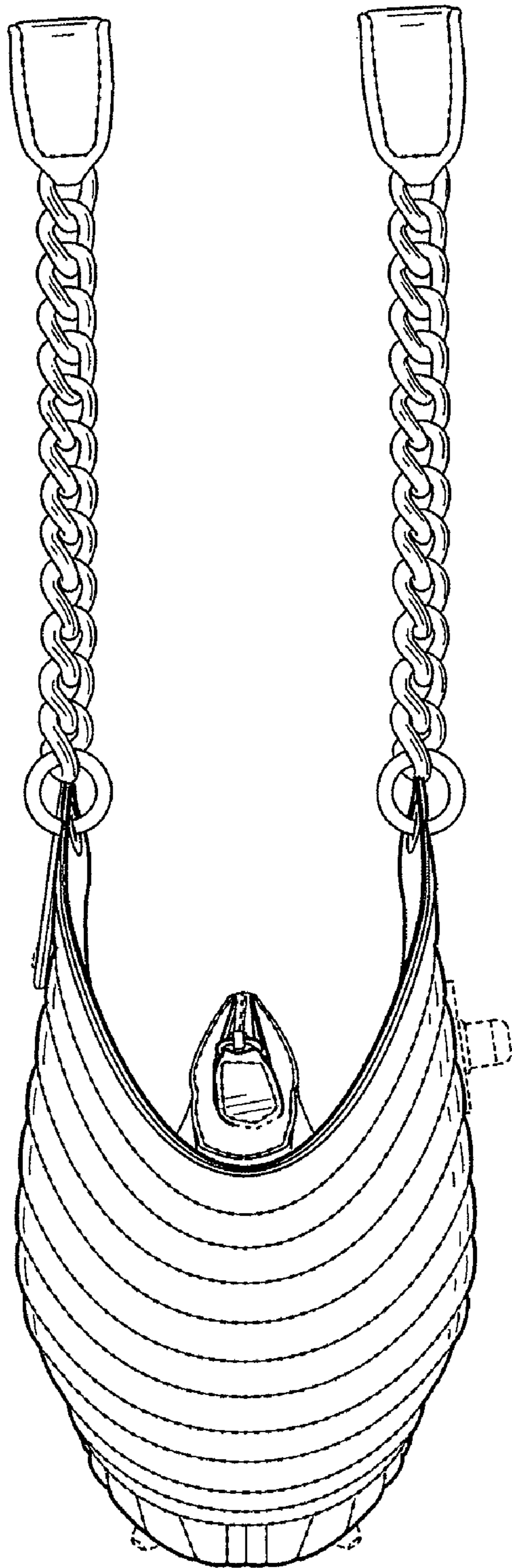

FIG. 10