



US00D582482S

(12) **United States Design Patent**
Schenker

(10) **Patent No.:** **US D582,482 S**

(45) **Date of Patent:** **** Dec. 9, 2008**

(54) **FILE BOX**

(75) Inventor: **David A. Schenker**, Cedarburg, WI (US)

(73) Assignee: **Innovative Storage Designs, Inc.**,
Mequon, WI (US)

(**) Term: **14 Years**

(21) Appl. No.: **29/295,343**

(22) Filed: **Sep. 27, 2007**

(51) **LOC (8) Cl.** **19-02**

(52) **U.S. Cl.** **D19/86**

(58) **Field of Classification Search** D3/281,
D3/282, 294, 304, 307, 905; D9/424, 425;
D19/75-78, 86, 90, 91, 92; 206/215, 425;
220/380, 675, 780, 781, 782

See application file for complete search history.

(56) **References Cited**

U.S. PATENT DOCUMENTS

4,848,580	A	*	7/1989	Wise	206/519
D328,425	S	*	8/1992	Brightbill	D3/282
D330,162	S	*	10/1992	Verchere	D9/424
D342,609	S	*	12/1993	Brightbill	D3/294
D378,874	S	*	4/1997	Dickinson et al.	D3/281
D379,266	S	*	5/1997	Dickinson et al.	D3/281

D382,403	S	*	8/1997	Koskinen	D3/307
D389,309	S	*	1/1998	Shaw	D3/294
D404,916	S	*	2/1999	Dickinson et al.	D3/281
D408,142	S	*	4/1999	Song	D3/282
D419,442	S	*	1/2000	McClung et al.	D9/425
D495,597	S	*	9/2004	Rubalcava et al.	D9/425

* cited by examiner

Primary Examiner—Elizabeth A Albert

(74) *Attorney, Agent, or Firm*—Andrus, Scales, Starke &
Sawall, LLP

(57) **CLAIM**

The ornamental design for a file box, as shown and described.

DESCRIPTION

FIG. 1 is a front perspective view of the file box;

FIG. 2 is a front elevation view of the file box;

FIG. 3 is a left side elevation view of the file box;

FIG. 4 is a top plan view of the file box; and,

FIG. 5 is a bottom plan view of the file box.

The broken line showing of the unclaimed part of the file box in all figures is included for the purpose of illustrating environment and forms no part of the claimed design.

1 Claim, 5 Drawing Sheets

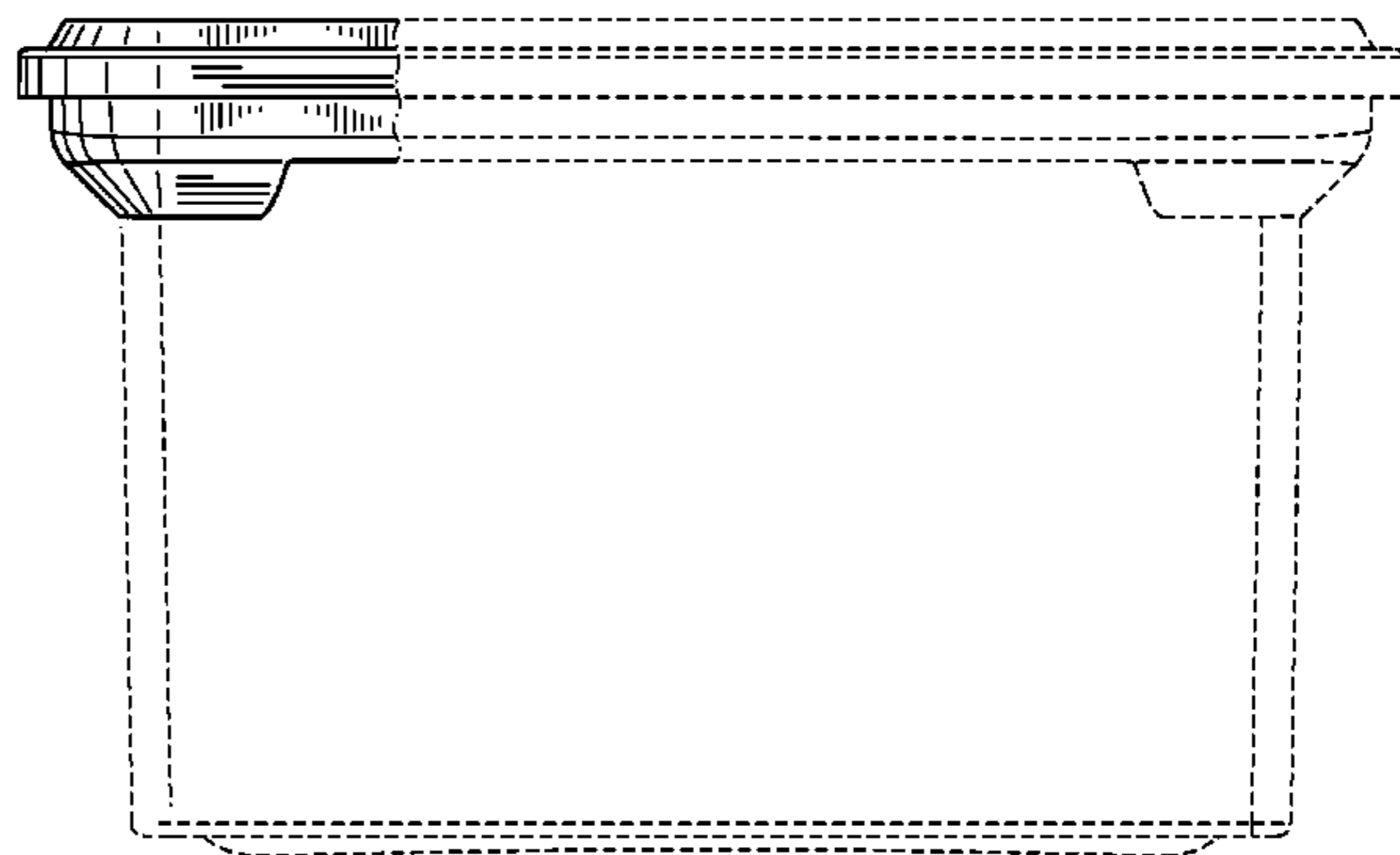
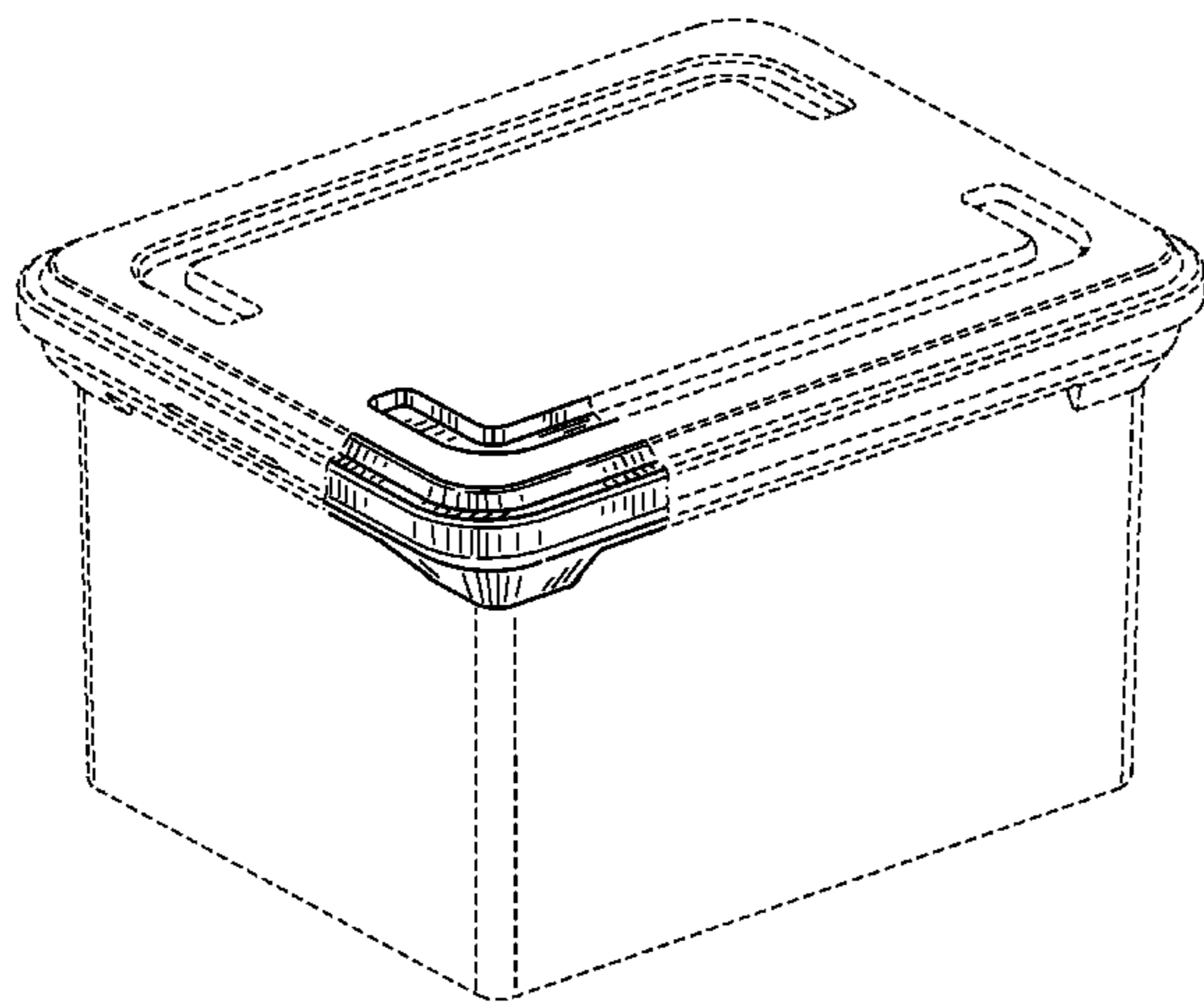

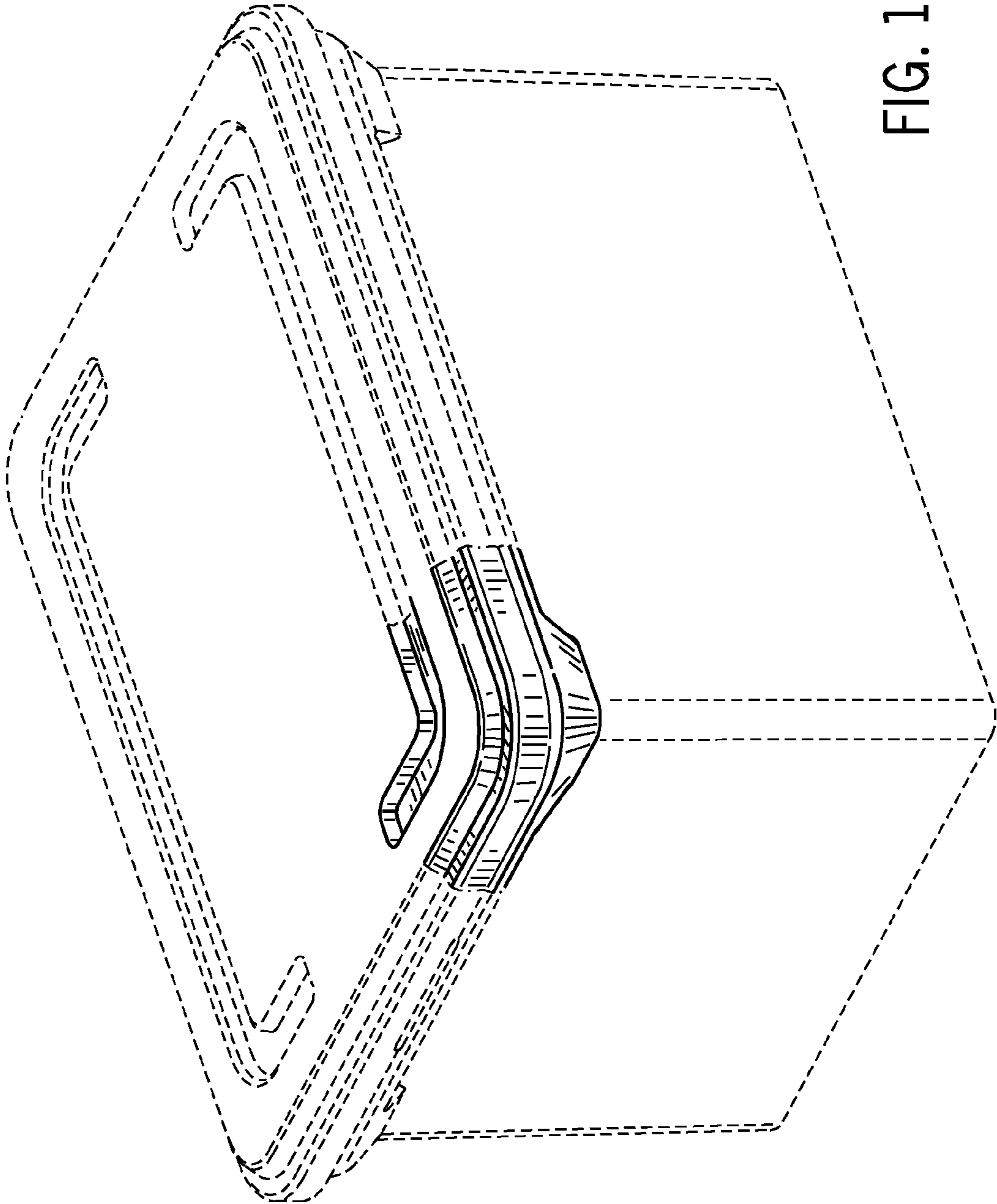

FIG. 1

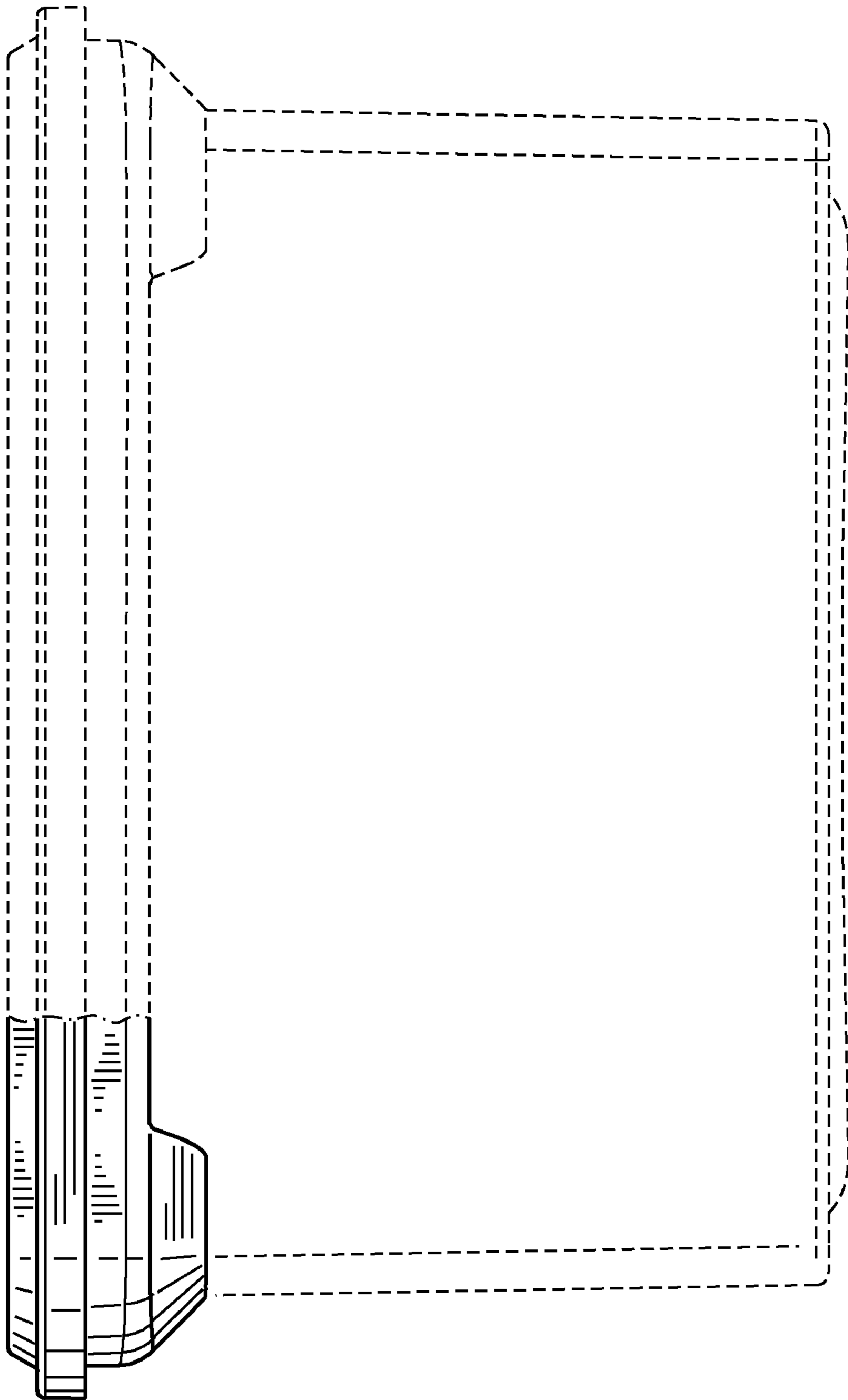

FIG. 2

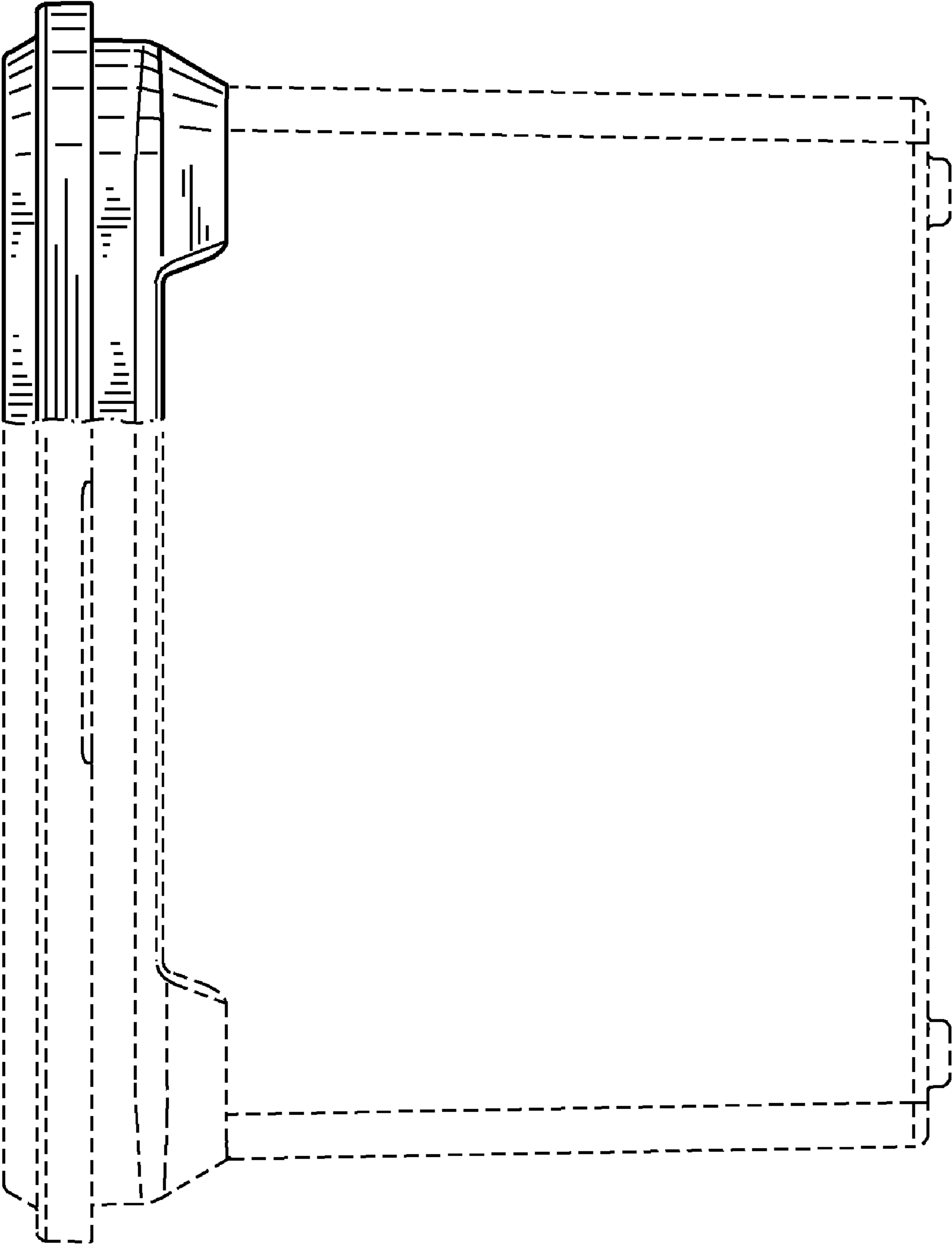

FIG. 3

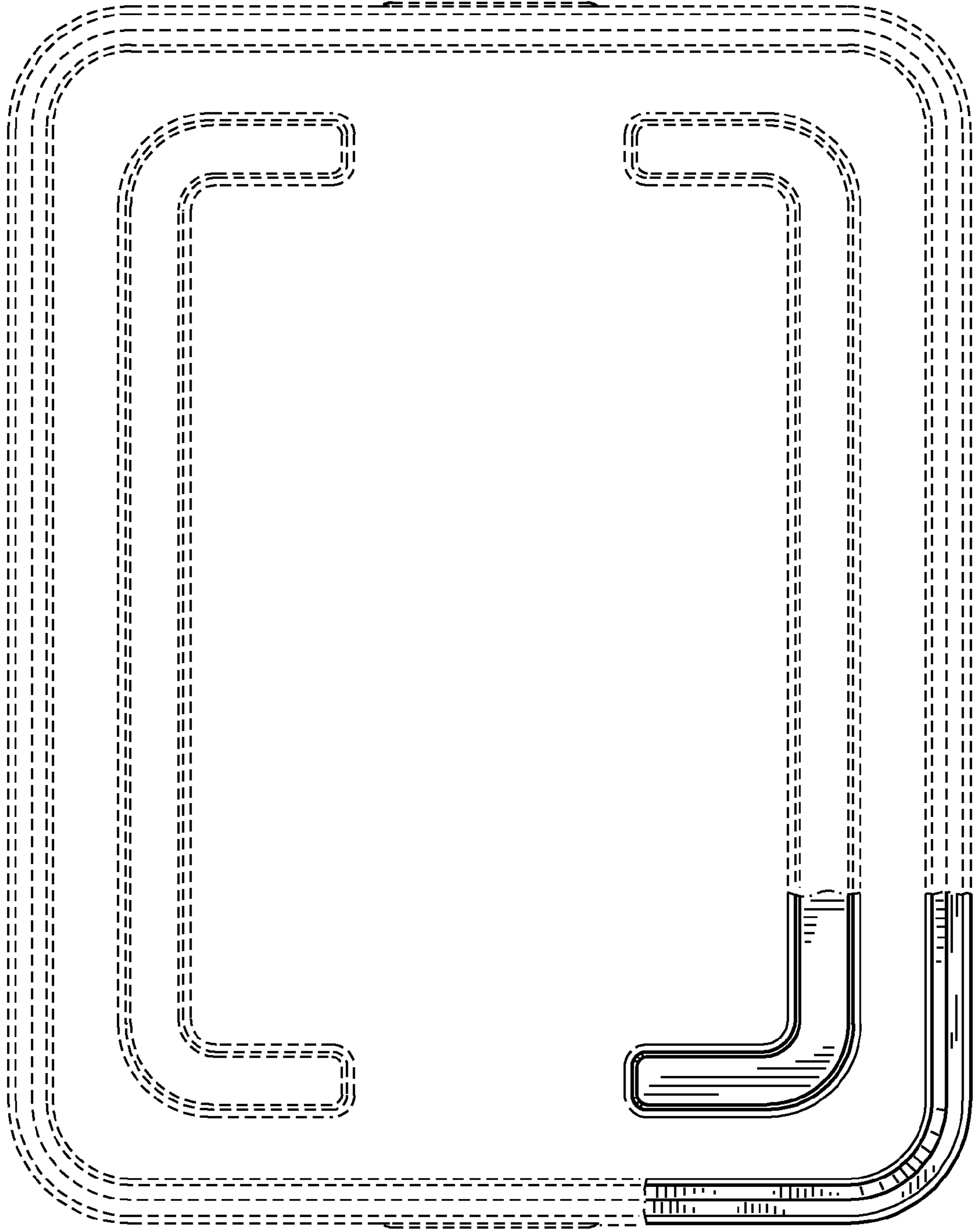

FIG. 4

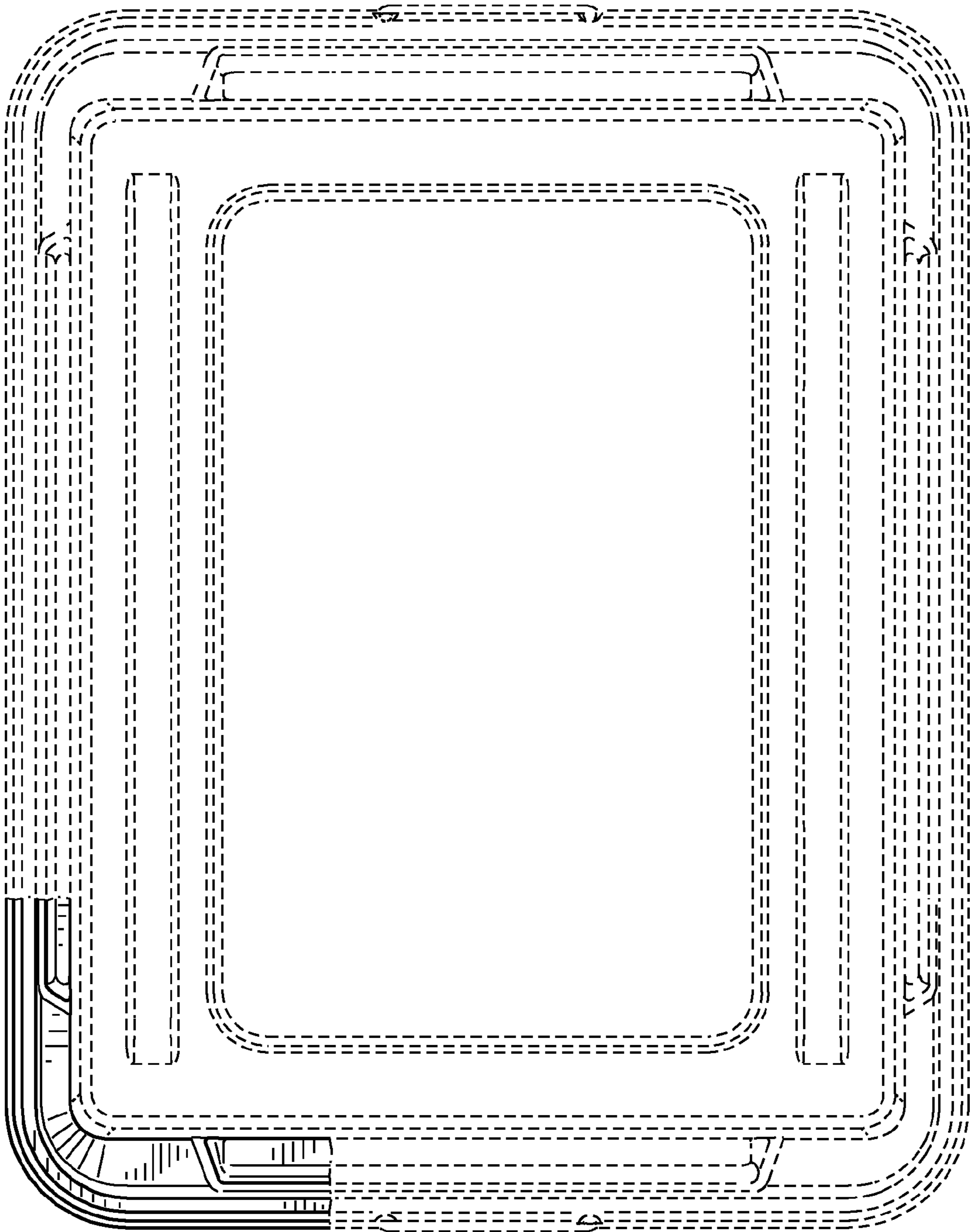

FIG. 5