



US00D582394S

(12) **United States Design Patent**  
**Hong et al.**

(10) **Patent No.:** **US D582,394 S**  
(45) **Date of Patent:** **\*\* Dec. 9, 2008**

(54) **AUDIO COMPONENT**

(75) Inventors: **Kyung Min Hong**, Yongin-Shi (KR);  
**Kyoung Joung Kim**, Seoul (KR)

(73) Assignee: **LG Electronics Inc.**, Seoul (KR)

(\*\*) Term: **14 Years**

(21) Appl. No.: **29/300,098**

(22) Filed: **Feb. 20, 2008**

(30) **Foreign Application Priority Data**

Aug. 27, 2007 (KR) ..... 30-2007-0036573

(51) **LOC (8) Cl.** ..... **14-01**

(52) **U.S. Cl.** ..... **D14/216**; D14/496; D14/156

(58) **Field of Classification Search** ..... D14/496,  
D14/204, 209–216, 435, 474, 217, 188, 156,  
D14/168; 369/1, 2, 75.11, 86, 99, 6–12;  
455/344–351; 181/167, 198, 199, 151, 153;  
381/300–302, 306, 333, 345, 361–364, 386–388,  
381/332, 336

See application file for complete search history.

(56) **References Cited**

**U.S. PATENT DOCUMENTS**

D511,337 S \* 11/2005 Kim ..... D14/156

D514,122 S \* 1/2006 Rodarte ..... D14/496

D516,082 S \* 2/2006 Lewis ..... D14/496  
D527,704 S \* 9/2006 Rodarte ..... D13/108  
D544,881 S \* 6/2007 Yang et al. .... D14/496  
D554,614 S \* 11/2007 Lin ..... D14/156  
D560,211 S \* 1/2008 Kim et al. .... D14/216  
D567,818 S \* 4/2008 Zhang ..... D14/496  
7,395,090 B2 \* 7/2008 Alden ..... 455/557  
7,398,535 B2 \* 7/2008 Zhang ..... 720/600

\* cited by examiner

*Primary Examiner*—Prabhakar Deshmukh

(74) *Attorney, Agent, or Firm*—Morgan Lewis & Bockius LLP

(57) **CLAIM**

We claim the ornamental design for an audio component, as shown and described.

**DESCRIPTION**

FIG. 1 is a perspective view of audio component showing the new design:

FIG. 2 is a front elevation view thereof;

FIG. 3 is a rear elevation view thereof;

FIG. 4 is a left-side elevation view thereof;

FIG. 5 is a right-side elevation view thereof;

FIG. 6 is a top plan view thereof; and,

FIG. 7 is a bottom plan view thereof.

**1 Claim, 4 Drawing Sheets**

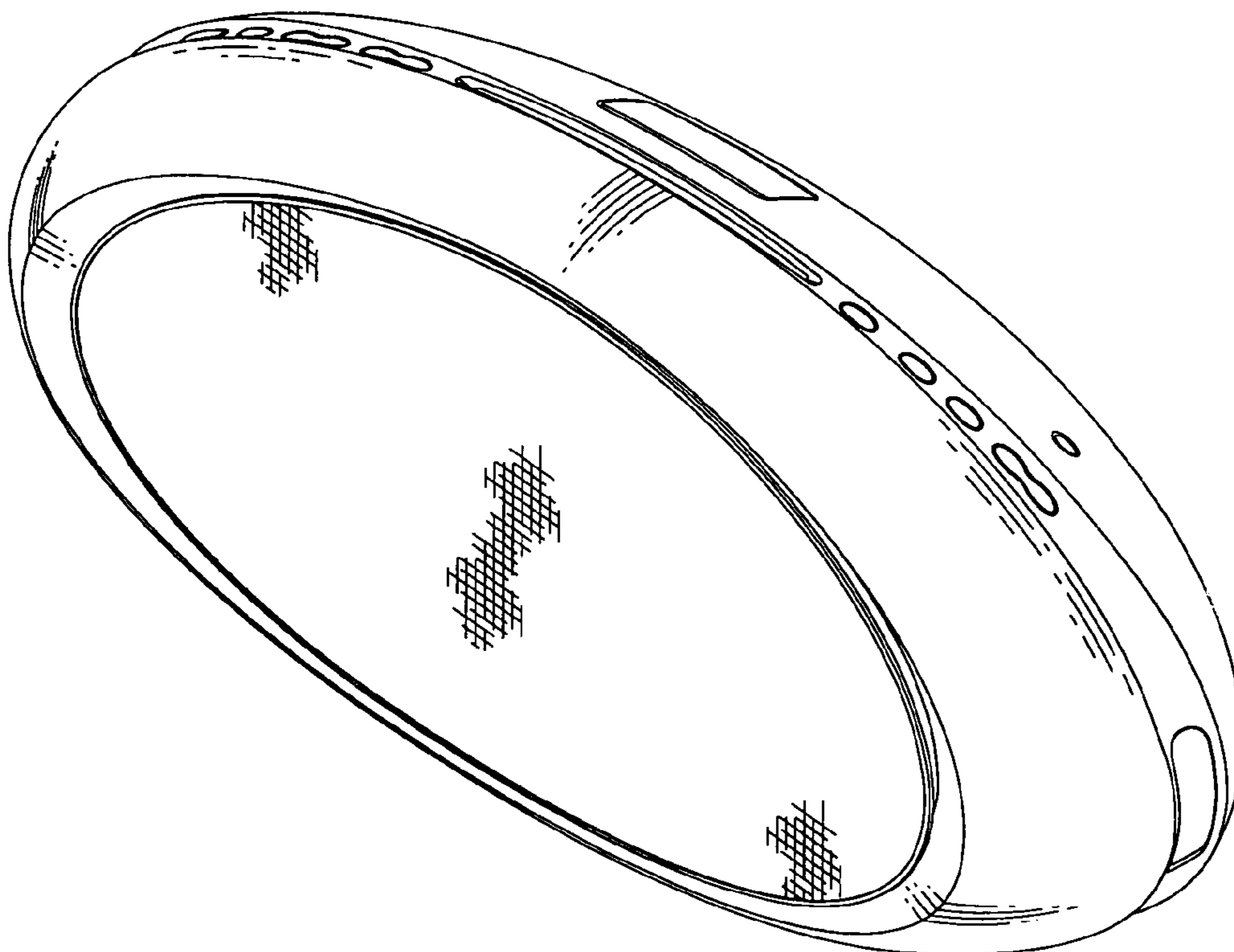

FIG. 1

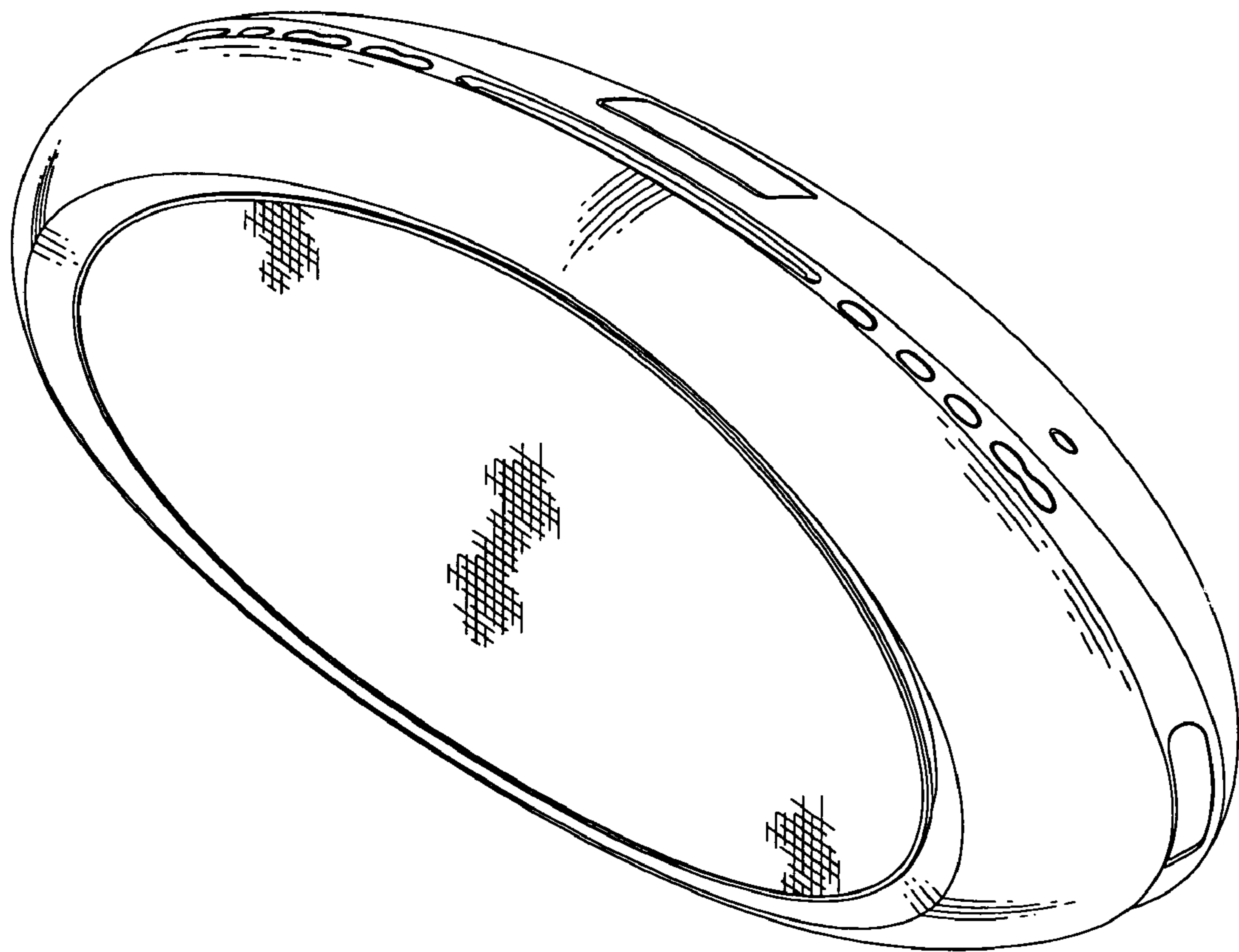

FIG. 2

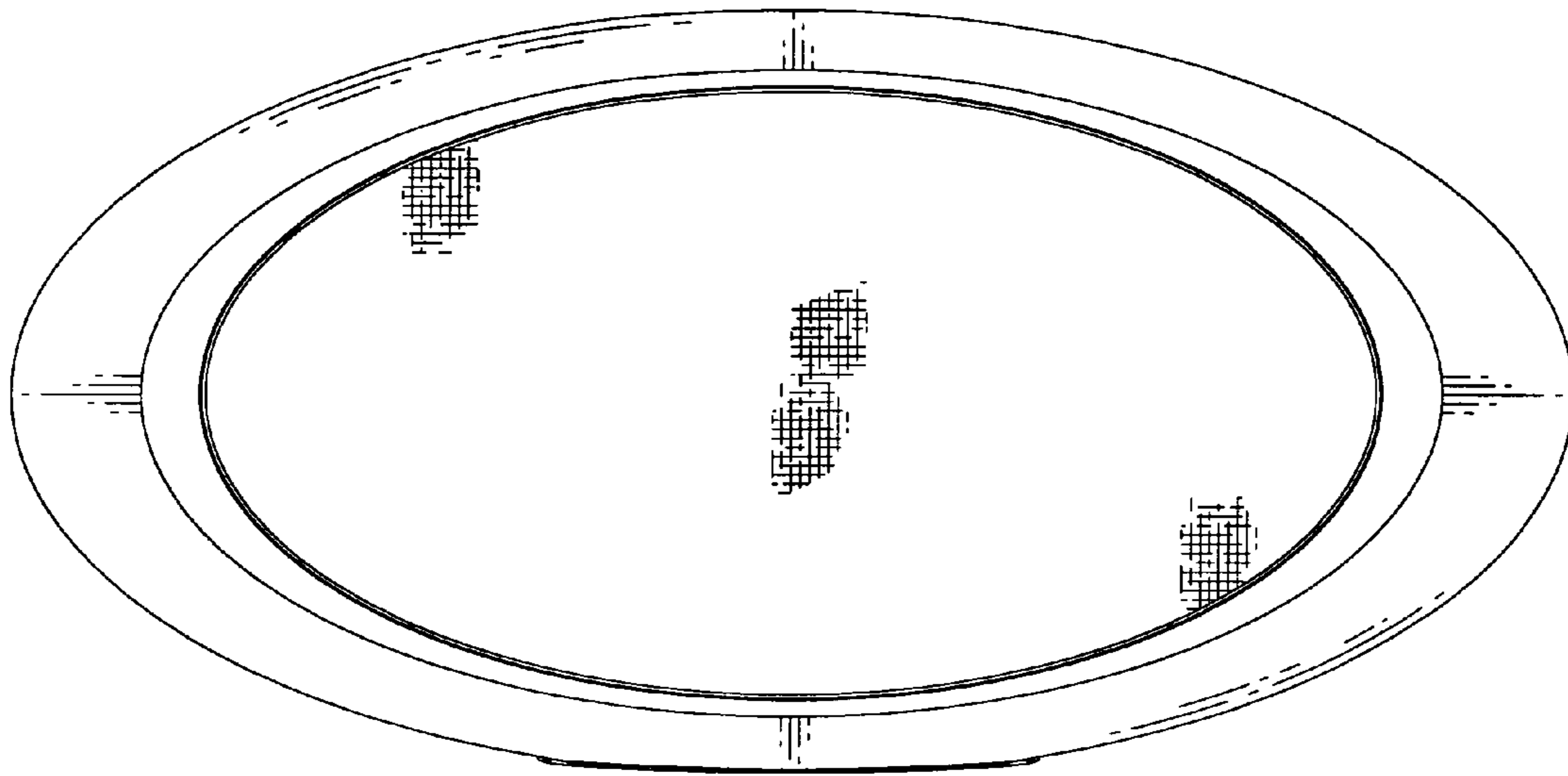

FIG. 3

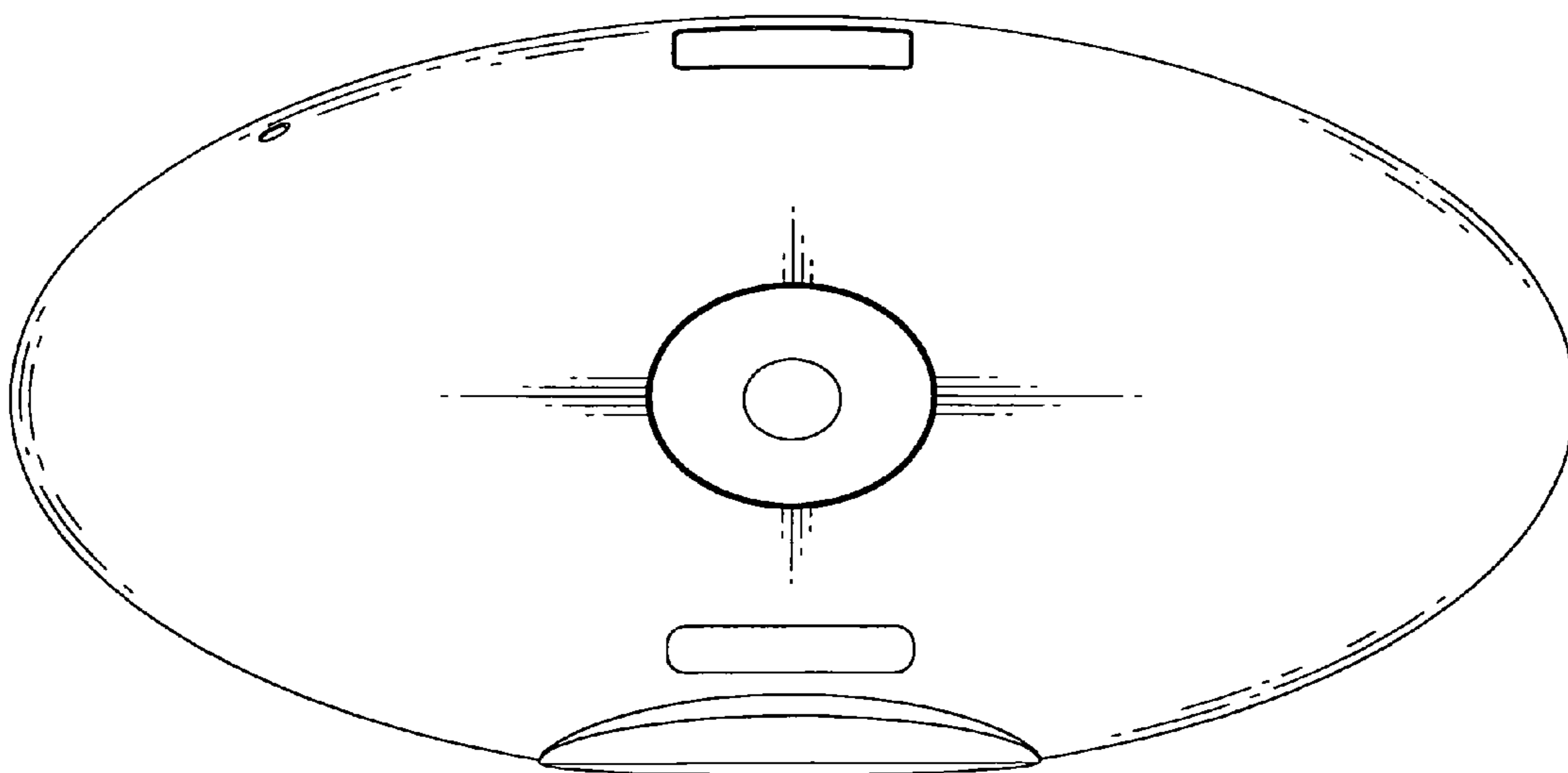

FIG. 4

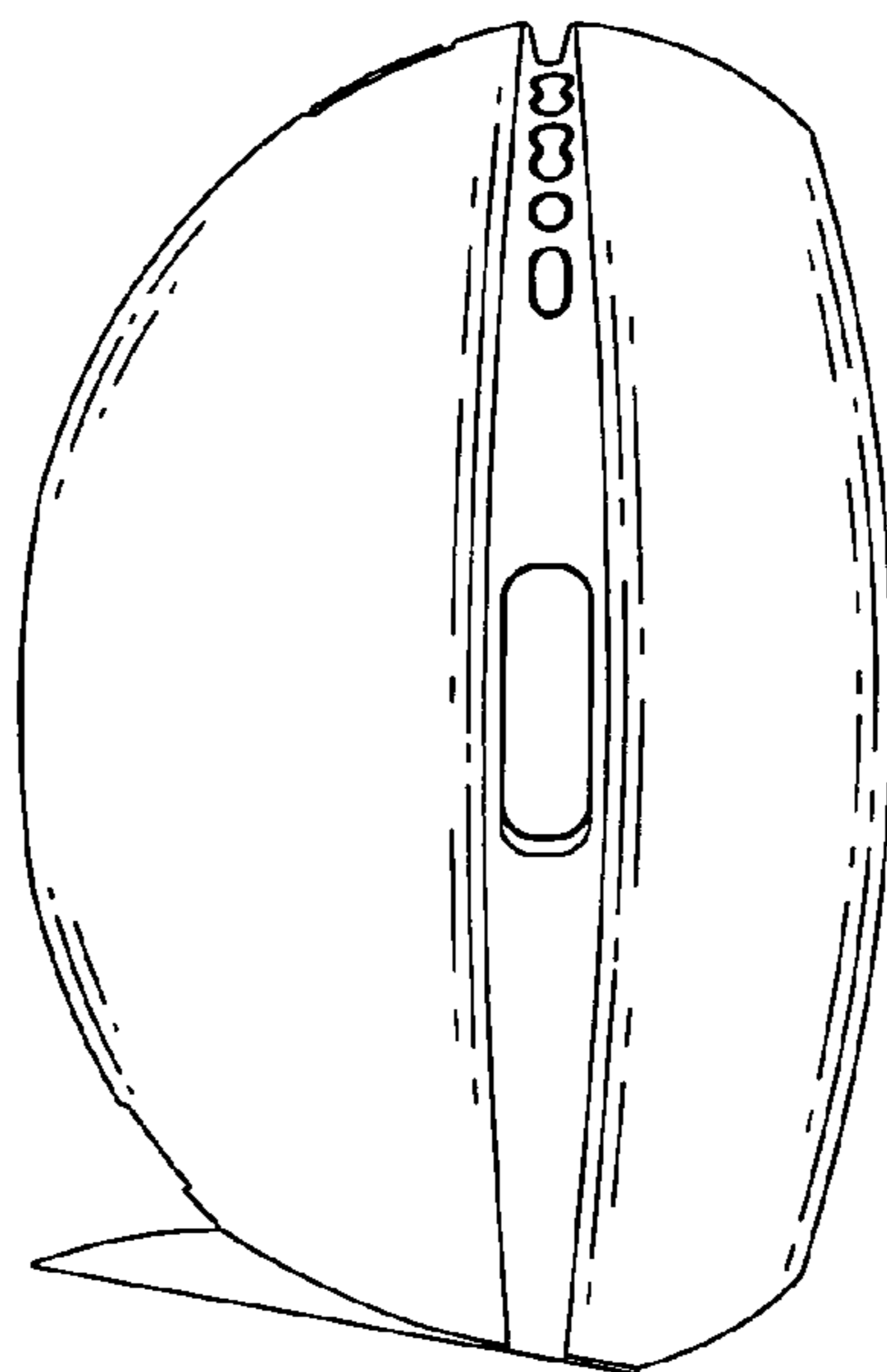

FIG. 5

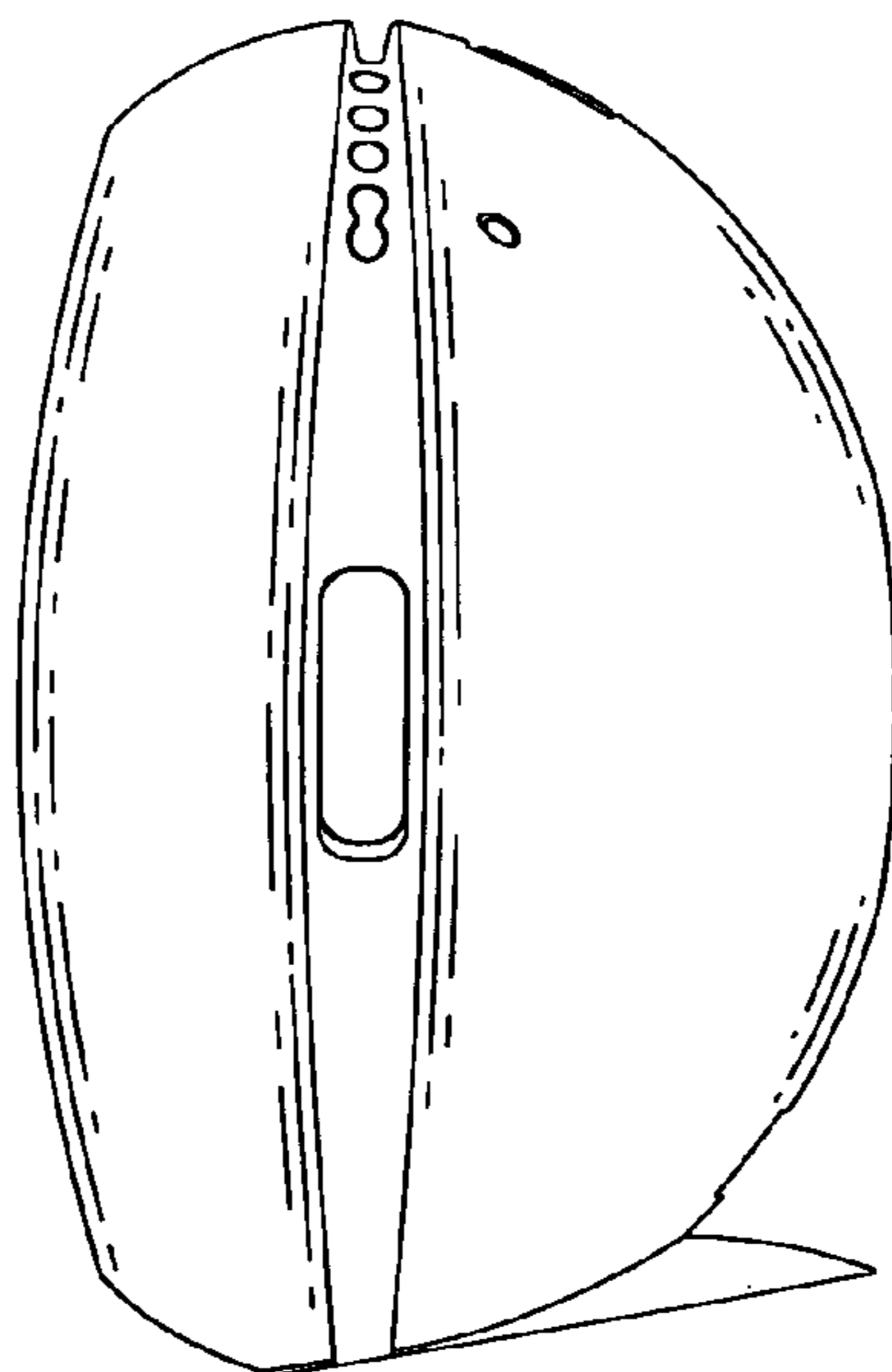

FIG.6

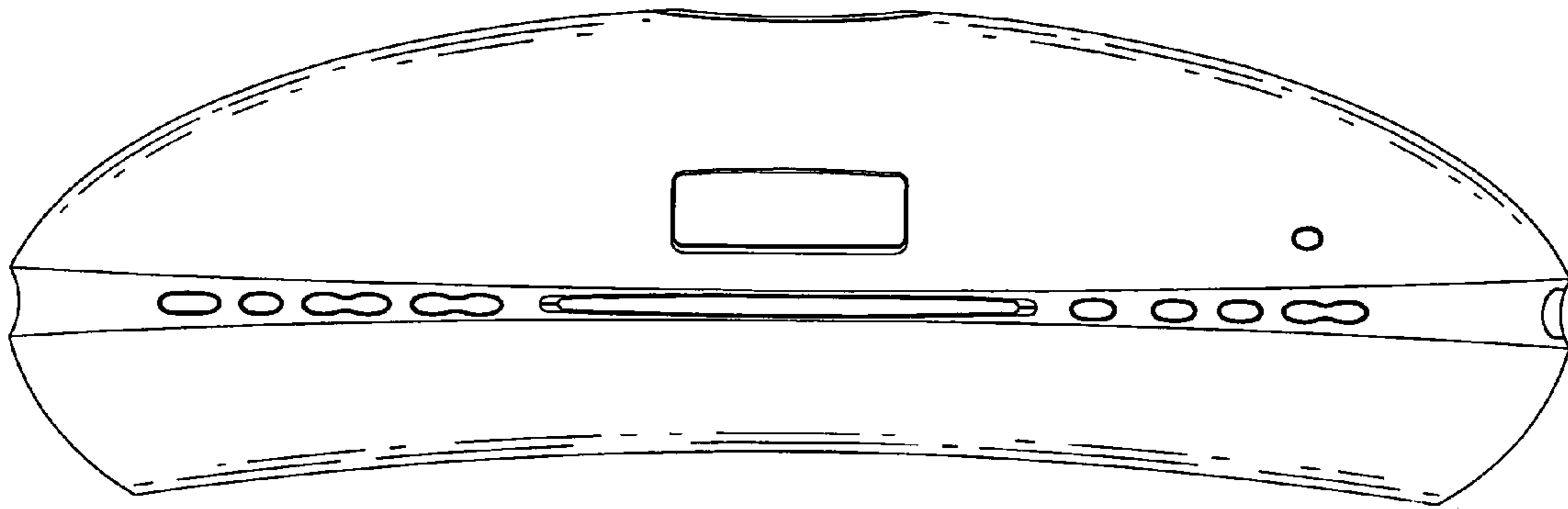

FIG.7

