



US00D582366S

(12) **United States Design Patent**
Yang et al.

(10) **Patent No.:** **US D582,366 S**
(45) **Date of Patent:** **** Dec. 9, 2008**

- (54) **LCD TELEVISION SET**
- (75) Inventors: **Jun-Ho Yang**, Kyunggi-do (KR);
Yun-Je Kang, Kyunggi-do (KR);
Kyoung-Hoon Kim, Seoul (KR)
- (73) Assignee: **Samsung Electronics Co., Ltd.**, Suwon,
Kyunggi-Do (KR)
- (**) Term: **14 Years**
- (21) Appl. No.: **29/307,943**
- (22) Filed: **May 20, 2008**
- (51) **LOC (8) Cl.** **14-03**
- (52) **U.S. Cl.** **D14/126**
- (58) **Field of Classification Search** D14/125-134,
D14/239, 371, 136, 374-377, 440, 450, 448,
D14/336, 342; 312/7.2; 348/836, 838, 180,
348/184, 325, 739; 341/12; 248/917-924,
248/465; 345/104, 133, 156, 168, 87, 173;
720/605, 669, 600, 655; 369/99, 197; 455/344,
455/347; D21/329, 515, 577, 622, 333, 433,
D21/448, 452, 450, 331; D6/477, 479; 273/148 B;
446/484, 175, 356; D10/15, 26
See application file for complete search history.

(56) **References Cited**
U.S. PATENT DOCUMENTS

D494,941 S	8/2004	Kim
D499,386 S	12/2004	Yang
D512,424 S	12/2005	Kim
D521,511 S	5/2006	Kim et al.
D521,996 S	5/2006	Kim et al.
D521,997 S	5/2006	Park et al.
D522,509 S	6/2006	Park et al.
D524,313 S	7/2006	Boo et al.
D527,003 S	8/2006	Kim et al.
D528,115 S	9/2006	Yoon
D528,116 S	9/2006	Won et al.
D529,910 S	10/2006	Ota
D532,764 S	11/2006	Kim et al.
D533,848 S	12/2006	Lee et al.
D534,510 S	1/2007	Kang et al.

D534,883 S	1/2007	Kang et al.
D535,267 S	1/2007	Kang et al.
D536,677 S	2/2007	Kim et al.
D537,079 S	2/2007	Park
D539,242 S	3/2007	Lee et al.
D539,281 S	3/2007	Kim et al.
D539,767 S	4/2007	Kang et al.
D540,277 S	4/2007	Kim et al.
D541,236 S	4/2007	Kim et al.
D541,763 S	5/2007	Kim
D542,746 S	5/2007	Kim
D542,747 S	5/2007	Kim et al.
D543,163 S	5/2007	Yang et al.
D543,164 S	5/2007	Yang et al.
D544,849 S	6/2007	Yang et al.
D545,312 S	6/2007	Kim

(Continued)

OTHER PUBLICATIONS

U.S. Appl. No. 29/269,013, Applicant: Jun-Ho Yang, et al., filed Nov. 17, 2006 entitled LCD Television Set.

(Continued)

Primary Examiner—Raphael Barkai
(74) *Attorney, Agent, or Firm*—Flynn, Thiel, Boutell & Tanis, P.C.

(57) **CLAIM**

The ornamental design for a LCD television set, as shown and described.

DESCRIPTION

FIG. 1 is a top front perspective view of a LCD television set showing our new design;
FIG. 2 is a front elevational view thereof;
FIG. 3 is a rear elevational view thereof;
FIG. 4 is a left side elevational view thereof;
FIG. 5 is a right side elevational view thereof;
FIG. 6 is a top plan view thereof; and,
FIG. 7 is a bottom plan view thereof.

1 Claim, 5 Drawing Sheets

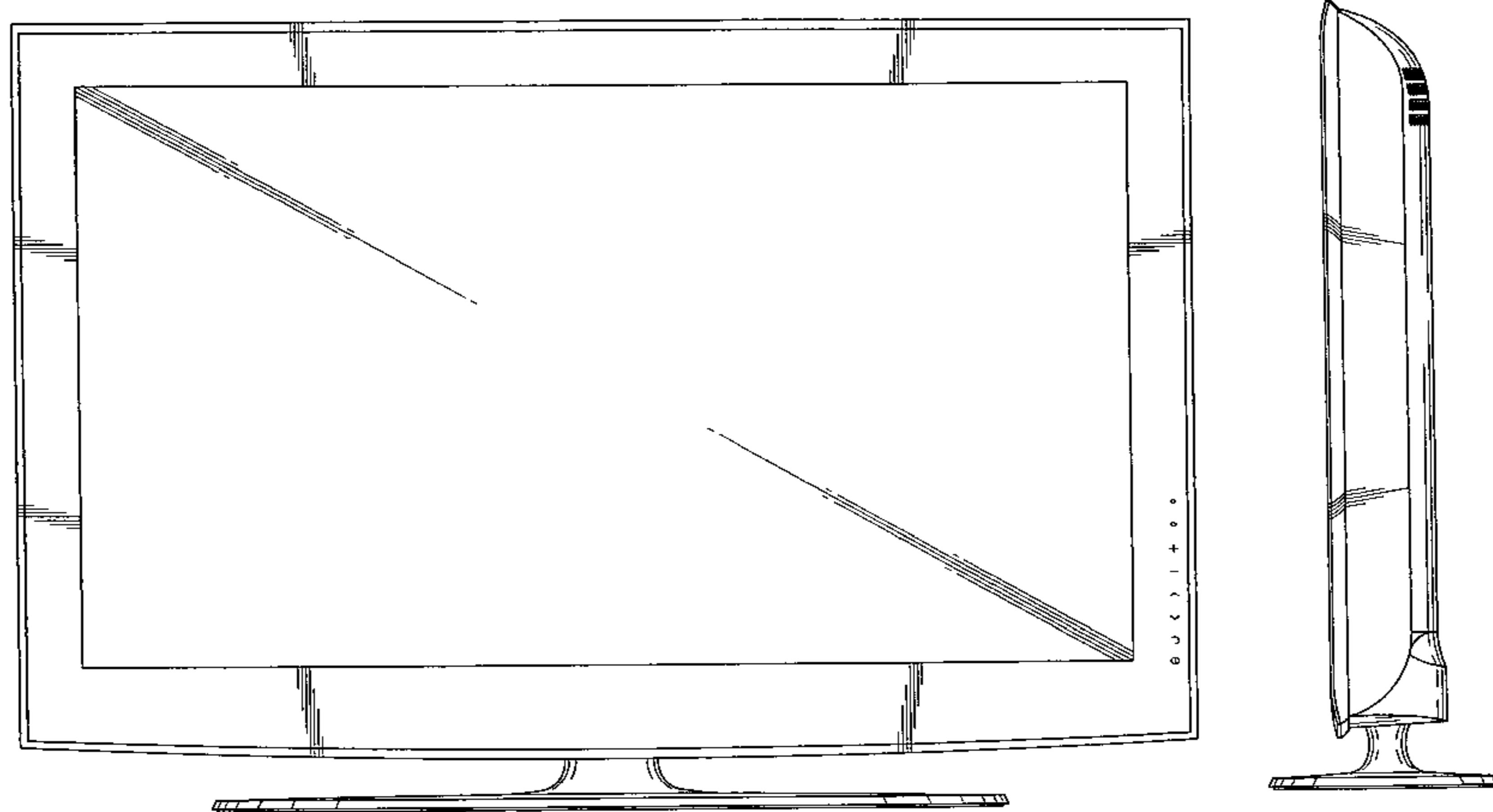

US D582,366 S

Page 2

U.S. PATENT DOCUMENTS

D545,313 S 6/2007 Kim
D545,314 S 6/2007 Kim
D545,315 S 6/2007 Kim
D545,316 S 6/2007 Kim
D545,776 S 7/2007 Kwon
D545,779 S * 7/2007 Kita D14/126
D545,820 S 7/2007 Won et al.
D546,331 S 7/2007 Kim
D547,276 S 7/2007 Yang et al.
D547,313 S 7/2007 Kim
D548,205 S 8/2007 Kim et al.
D548,206 S 8/2007 Han
D548,708 S 8/2007 Park et al.
D551,186 S 9/2007 Yang et al.
D551,194 S 9/2007 Kim et al.
D551,636 S 9/2007 Kang et al.
D553,108 S 10/2007 Won et al.
D554,601 S 11/2007 Won et al.
D556,159 S 11/2007 Park et al.
D556,160 S 11/2007 Lee et al.
D556,709 S 12/2007 Kim et al.
D556,755 S 12/2007 Lee et al.
D556,756 S 12/2007 Kataoka et al.
D556,757 S 12/2007 Kim et al.
D558,201 S 12/2007 Park et al.
D558,696 S 1/2008 Park et al.
D561,130 S 2/2008 Won et al.
D561,134 S 2/2008 Kim et al.
D561,135 S 2/2008 Won et al.
D561,136 S 2/2008 Won et al.
D564,472 S 3/2008 Won et al.
D565,521 S 4/2008 Yang et al.
D567,198 S 4/2008 Yang et al.

D567,199 S 4/2008 Kim et al.
D567,201 S * 4/2008 Profit D14/126
D569,818 S 5/2008 Kim et al.
D570,841 S 6/2008 Kim et al.
D571,320 S * 6/2008 Kita D14/126

OTHER PUBLICATIONS

U.S. Appl. No. 29/301,658, Applicant: Eui-Seok Kim, et al., filed Mar. 12, 2008 entitled LCD Monitor.
U.S. Appl. No. 29/291,990, Applicant: Dong-Hee Won, et al., filed Sep. 25, 2007 entitled LCD Television Receiver.
U.S. Appl. No. 29/271,976, Applicant: Kyoung-Hoon Kim, et al., filed Jan. 30, 2007 entitled LCD Television Set.
U.S. Appl. No. 29/271,977, Applicant: Jae-Beom Park, filed Jan. 30, 2007 entitled LCD Monitor.
U.S. Appl. No. 29/286,893, Applicant: Seung-Ho Lee, et al., filed May 22, 2007 entitled LCD Television Set.
U.S. Appl. No. 29/286,895, Applicant: Seung-Ho Lee, et al., filed May 22, 2007 entitled LCD Television Set.
U.S. Appl. No. 29/293,974, Applicant: Eui-Seok Kim, et al., filed Dec. 19, 2007 entitled LCD Monitor.
U.S. Appl. No. 29/293,973, Applicant: Eui-Seok Kim, et al., filed Dec. 19, 2007 entitled LCD Monitor.
U.S. Appl. No. 29/291,993, Applicant: Jun-Ho Yang, et al., filed Sep. 25, 2007 entitled PDP Television Receiver.
U.S. Appl. No. 29/291,992, Applicant: Jun-Ho Yang, et al., filed Sep. 25, 2007 entitled PDP Television Receiver.
U.S. Appl. No. 29/301,676, Applicant: Eui-Seok Kim, et al., filed Mar. 12, 2008 entitled LCD Monitor.
U.S. Appl. No. 29/307,941, Applicant: Jun-Ho Yang, et al., filed May 20, 2008 entitled LCD Television Set.
U.S. Appl. No. 29/307,957, Applicant: Jae-Seung Song, et al., filed May 20, 2008 entitled LCD Monitor.

* cited by examiner

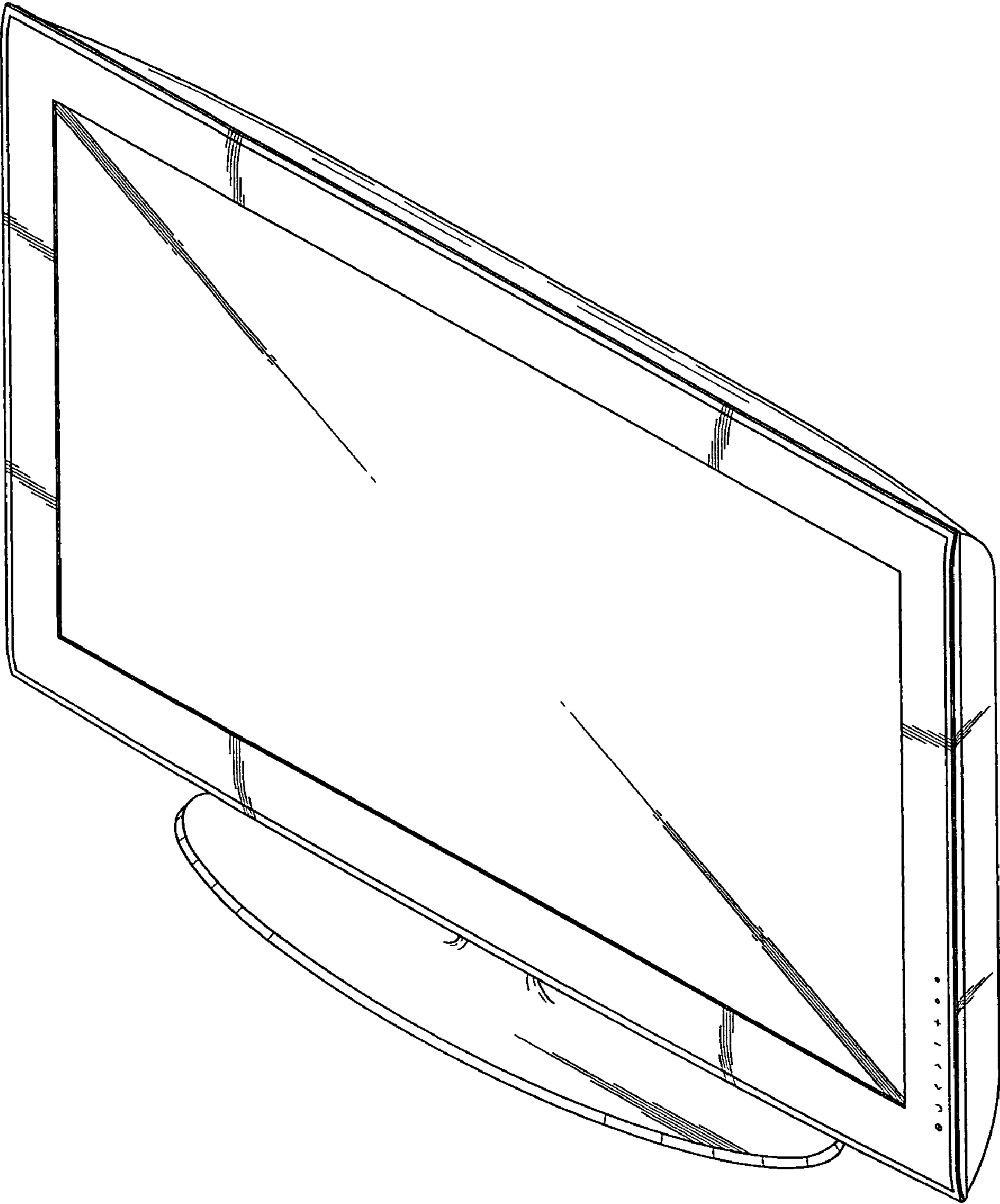

FIG. 1

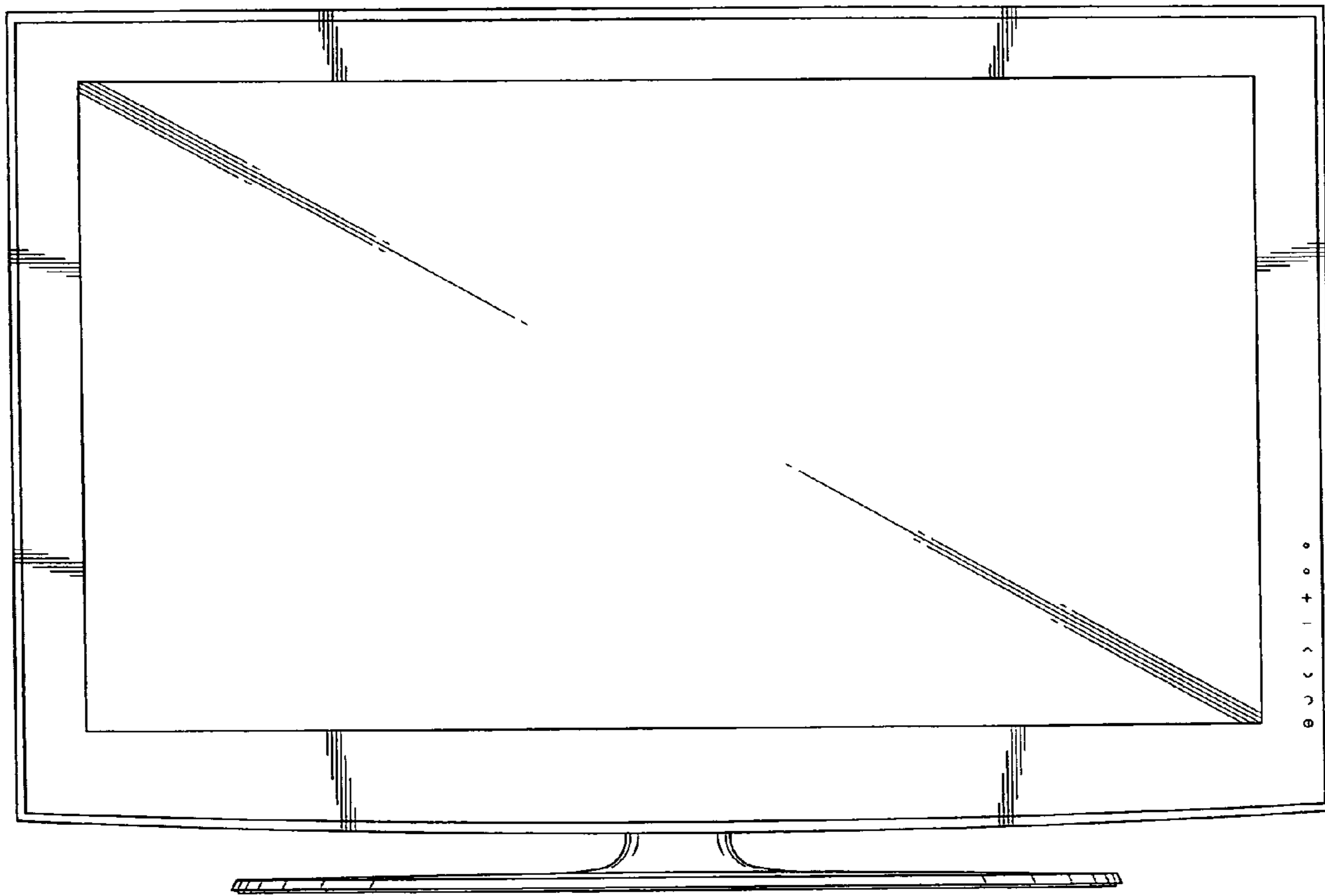

FIG. 2

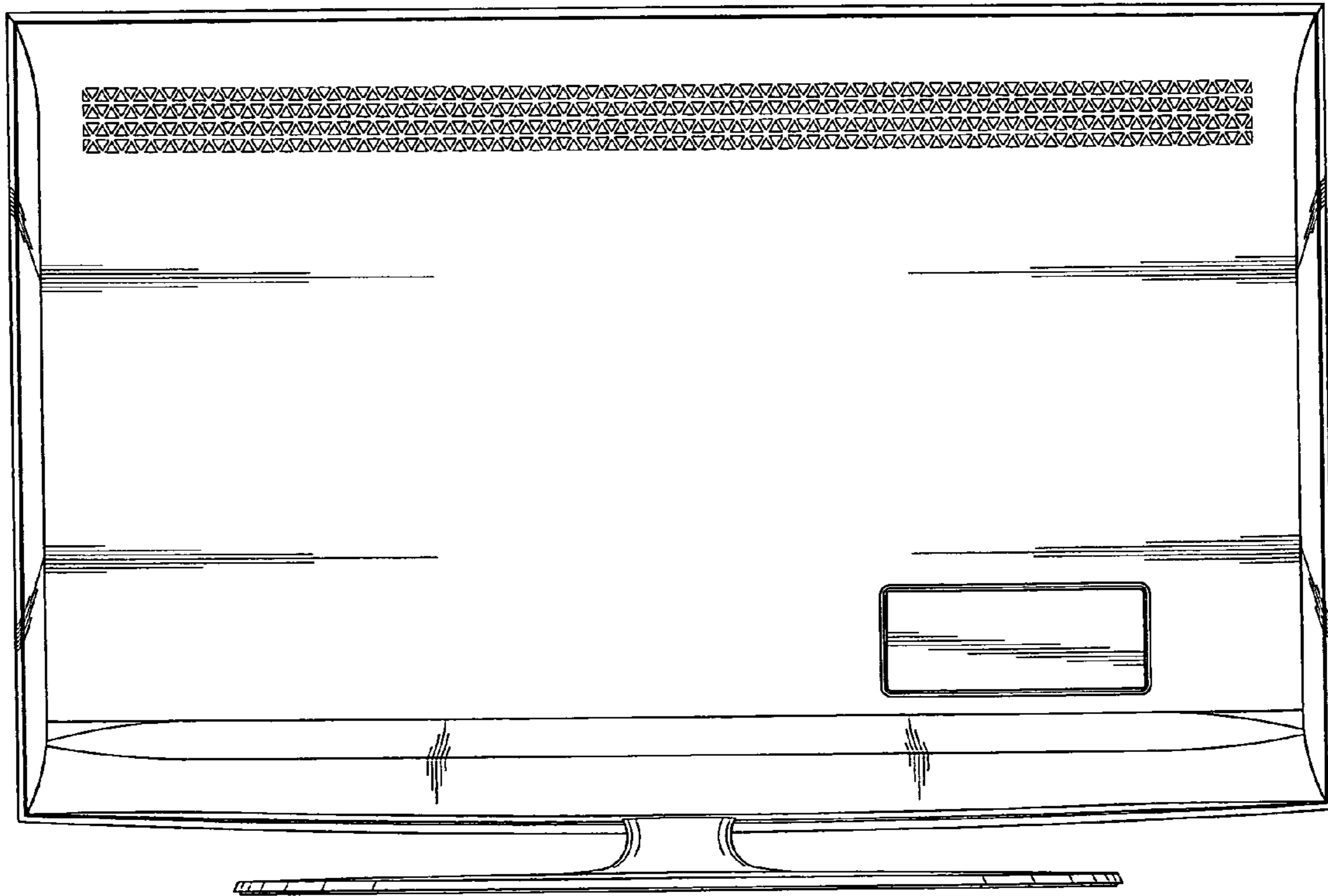

FIG.3

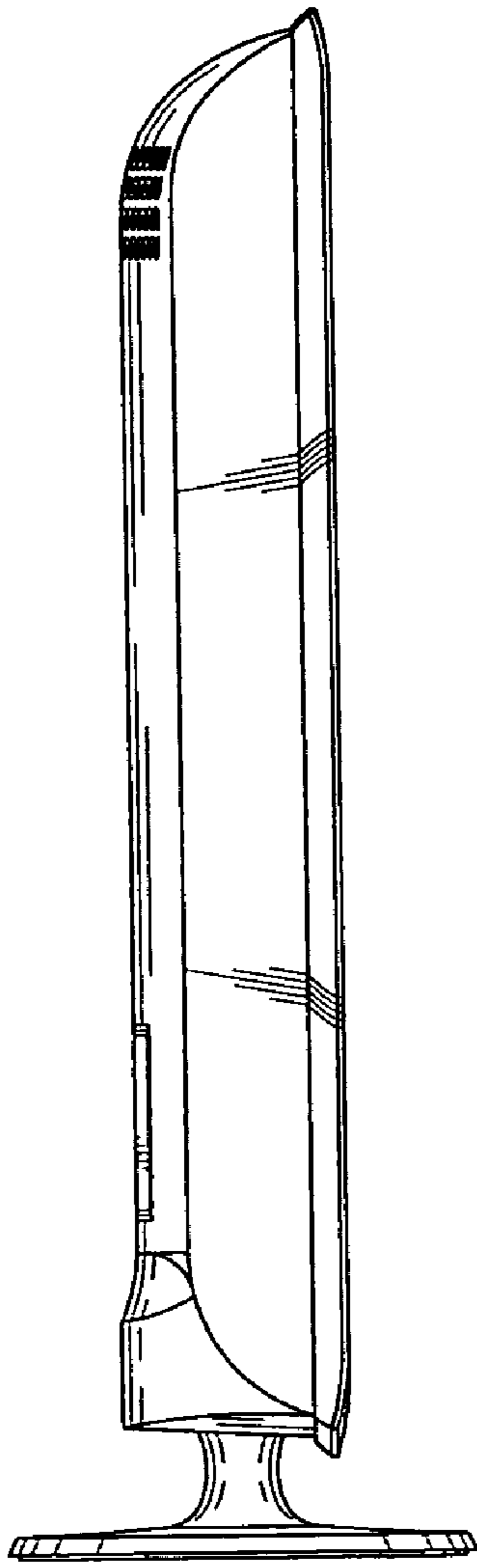

FIG. 4

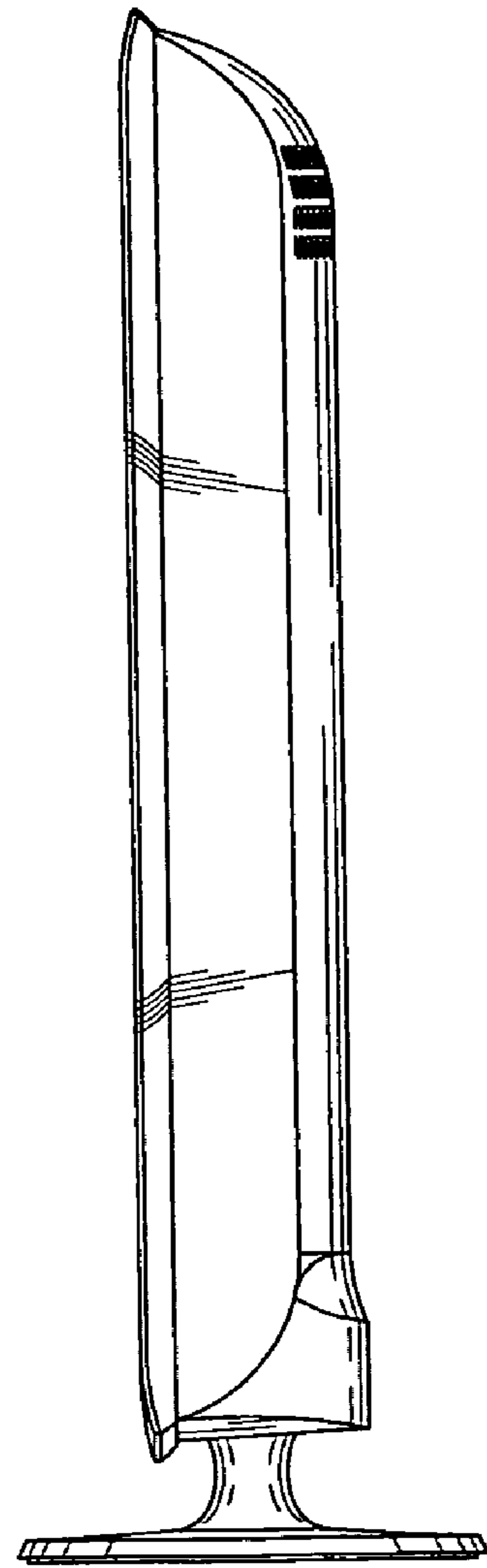

FIG. 5

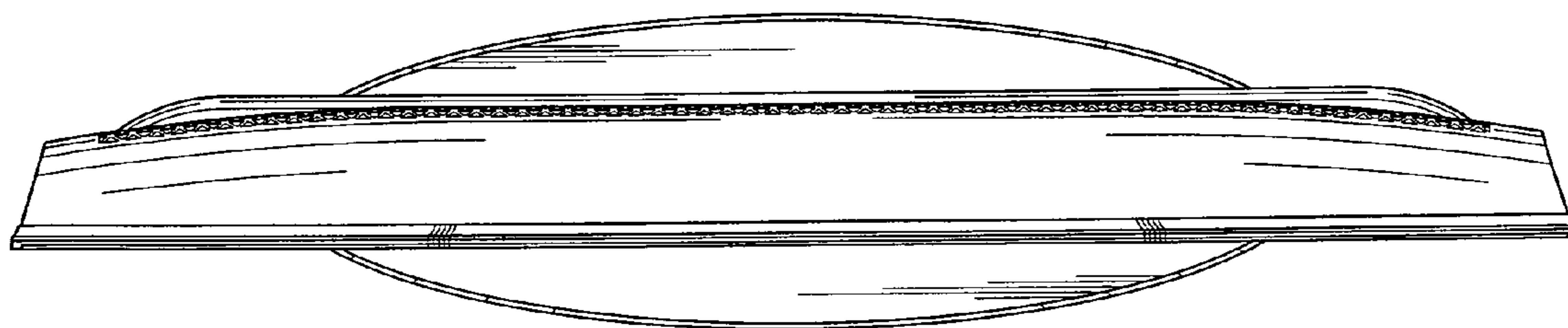

FIG. 6

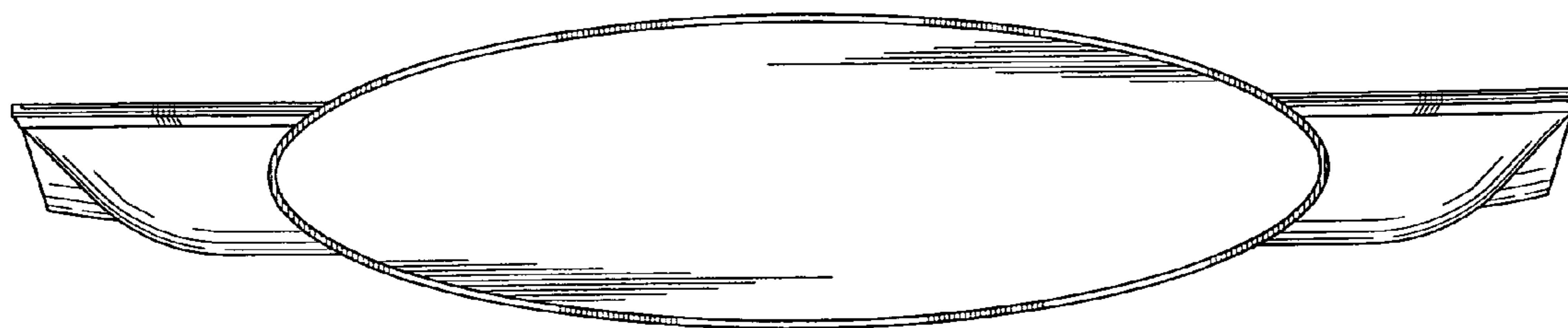

FIG. 7