



US00D582317S

(12) **United States Design Patent**  
**Takigawa et al.**

(10) **Patent No.:** **US D582,317 S**  
(45) **Date of Patent:** **\*\* Dec. 9, 2008**

(54) **MOTORCYCLE OR MOTORCYCLE REPLICA**

D559,738 S \* 1/2008 Takigawa et al. .... D12/110

\* cited by examiner

(75) Inventors: **Kanya Takigawa**, Wako (JP); **Daisuke Takahashi**, Wako (JP); **Paolo Cuccagna**, Rome (IT)

*Primary Examiner*—Cathron Brooks

*Assistant Examiner*—Linda Brooks

(74) *Attorney, Agent, or Firm*—Birch, Stewart, Kolasch & Birch, LLP

(73) Assignee: **Honda Motor Co., Ltd.**, Tokyo (JP)

(57) **CLAIM**

(\*\*) Term: **14 Years**

The ornamental design for a motorcycle or motorcycle replica, as shown and described.

(21) Appl. No.: **29/290,150**

(22) Filed: **Oct. 25, 2007**

**DESCRIPTION**

(30) **Foreign Application Priority Data**

Apr. 26, 2007 (JP) ..... 2007-011394

FIG. 1 is a perspective view from the left front side of a motorcycle or motorcycle replica.

FIG. 2 is a perspective view from the left rear side thereof.

FIG. 3 is perspective view from the right front side thereof.

FIG. 4 is a perspective view from the right rear side thereof.

FIG. 5 is a front elevation view thereof.

FIG. 6 is a rear elevation view thereof.

FIG. 7 is a top plan view thereof.

FIG. 8 is a bottom plan view thereof.

FIG. 9 is a left side elevation view thereof; and,

FIG. 10 is a right side elevation view thereof.

(51) **LOC (8) Cl.** ..... **12-11**

(52) **U.S. Cl.** ..... **D12/110**

(58) **Field of Classification Search** ..... D12/110;  
180/219, 220, 225, 229

See application file for complete search history.

(56) **References Cited**

**U.S. PATENT DOCUMENTS**

D288,796 S \* 3/1987 Nakano et al. .... D12/110

D516,468 S \* 3/2006 Kuboshima et al. .... D12/110

D531,090 S \* 10/2006 Iimura ..... D12/110

**1 Claim, 10 Drawing Sheets**

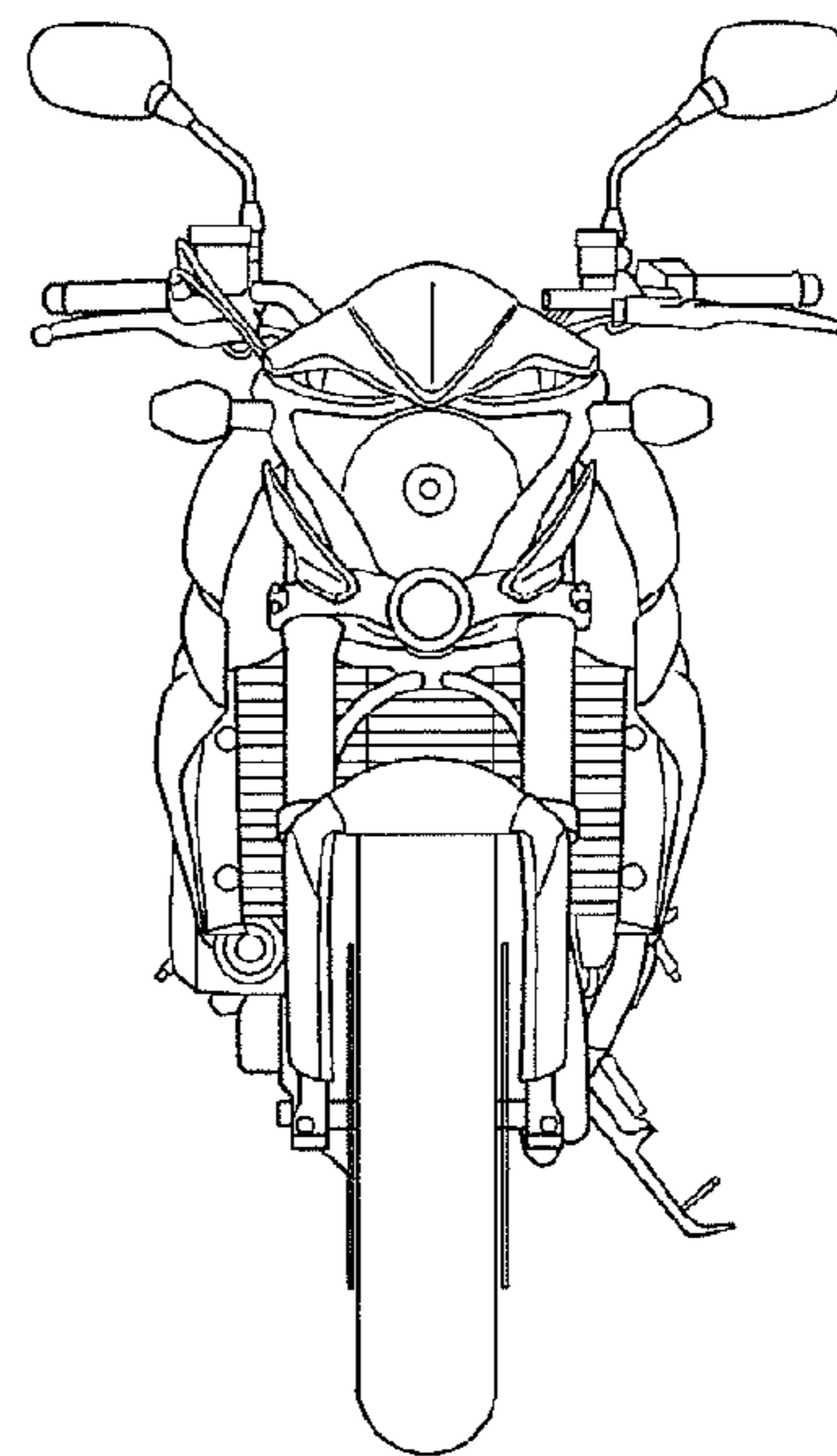
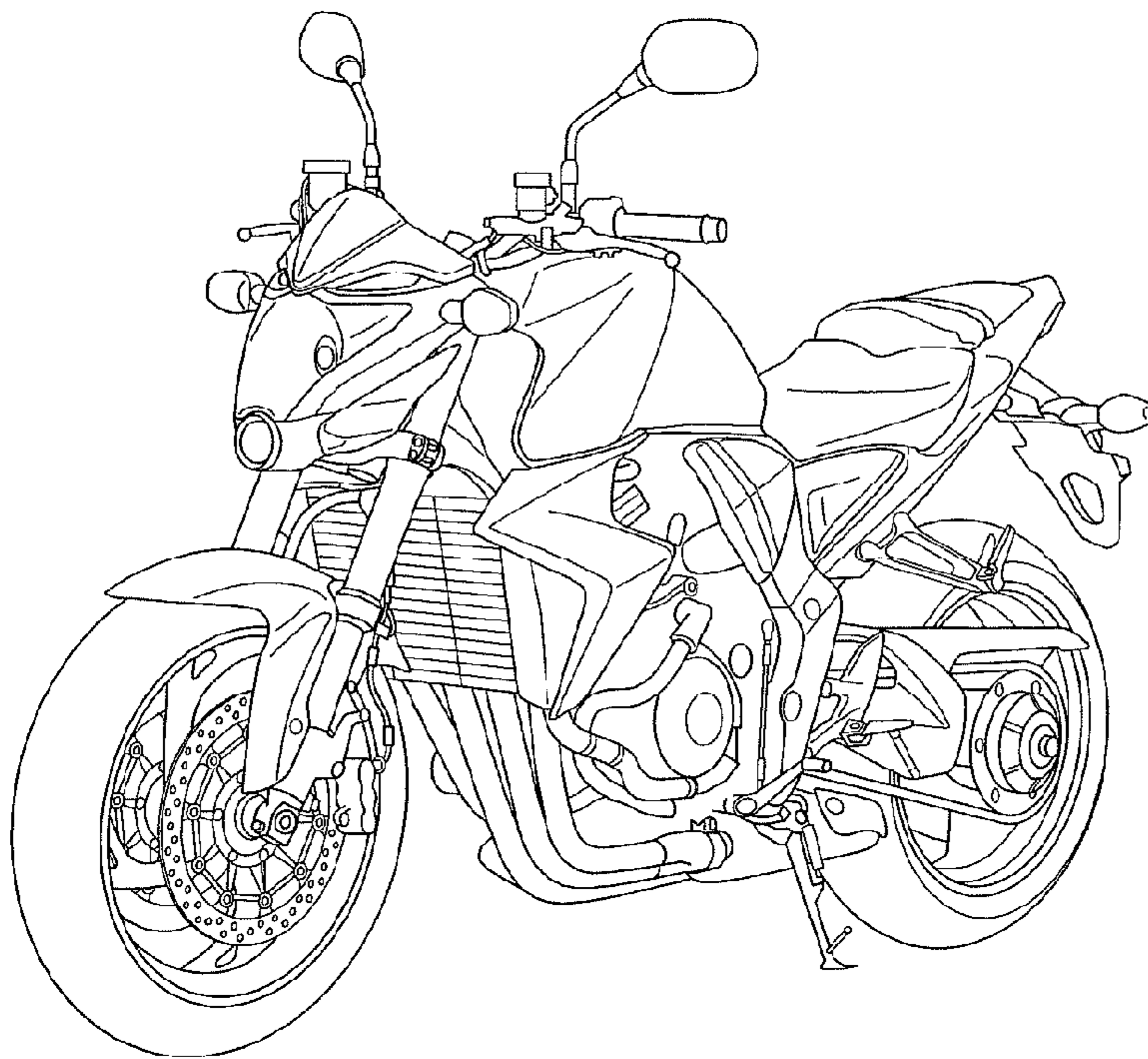

FIG. 1

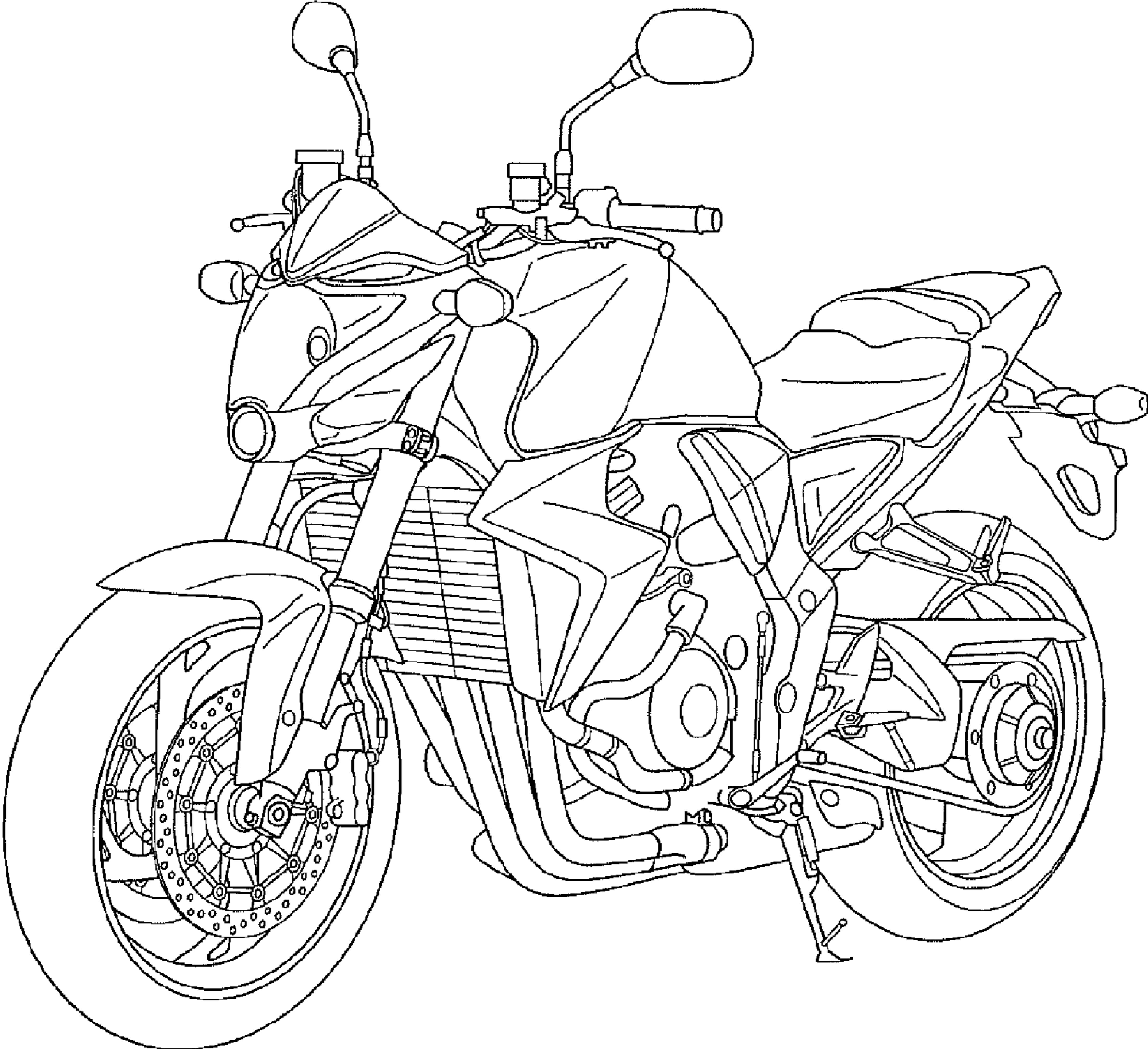

FIG. 2

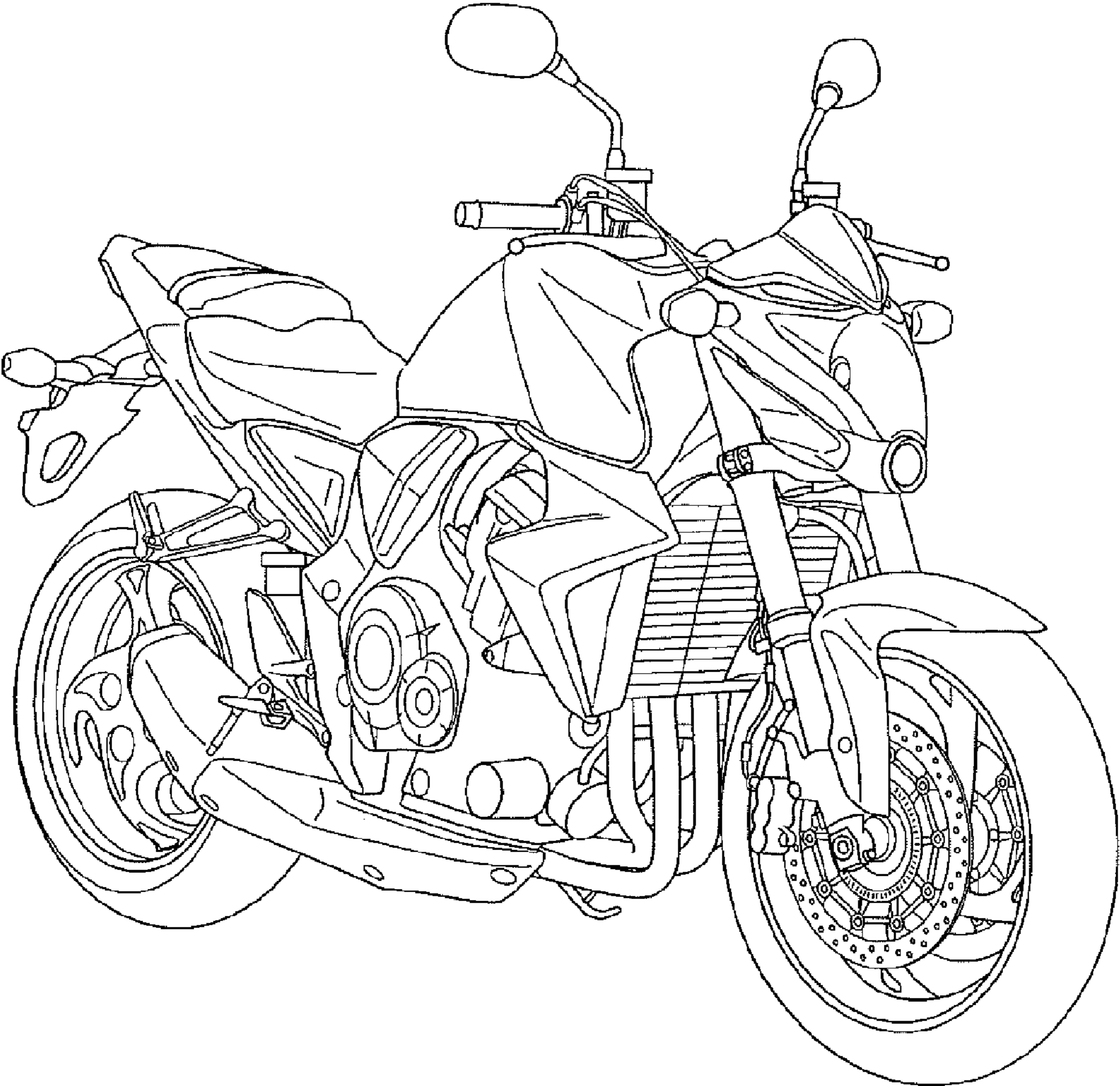

FIG. 3

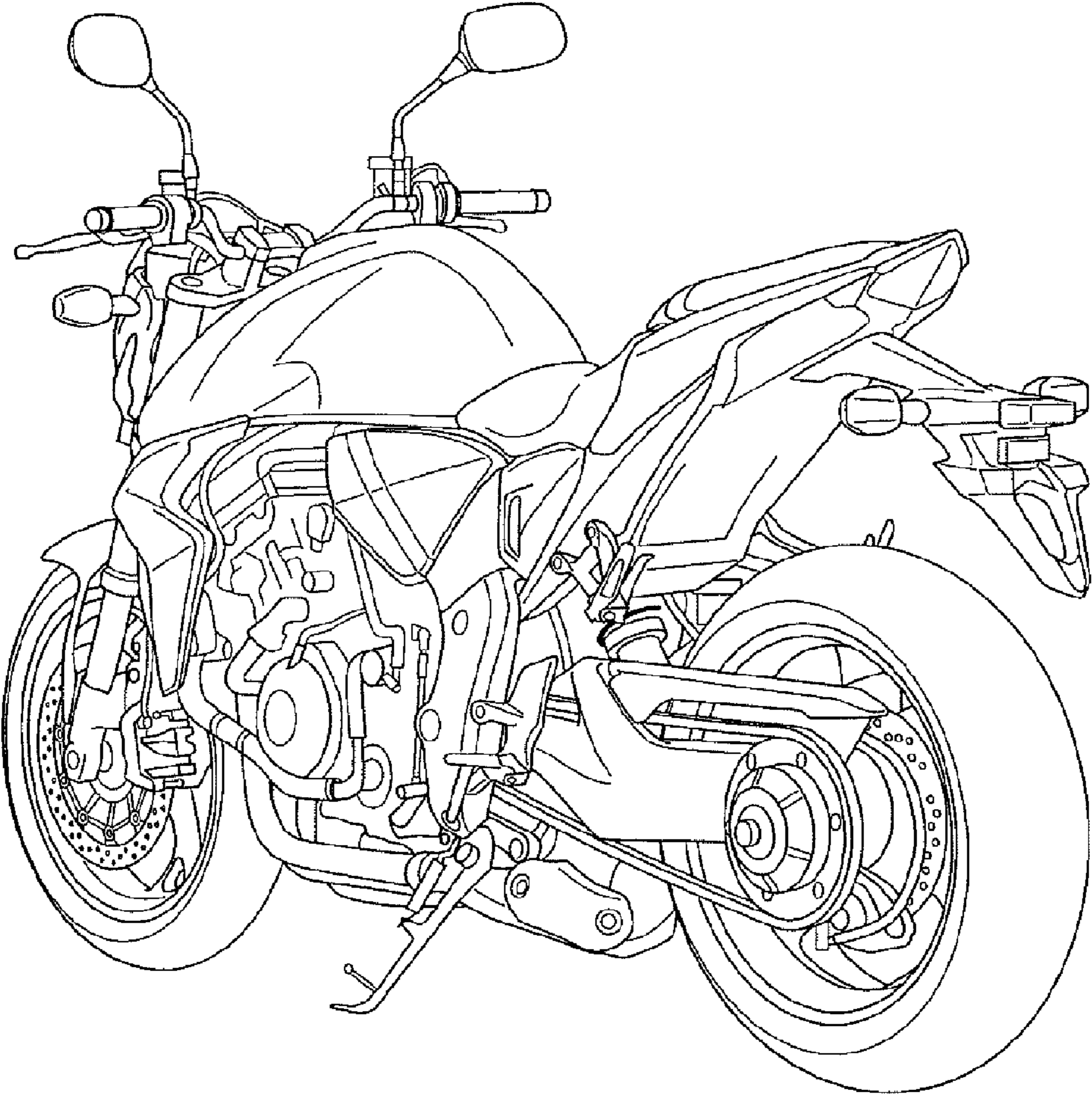

FIG. 4

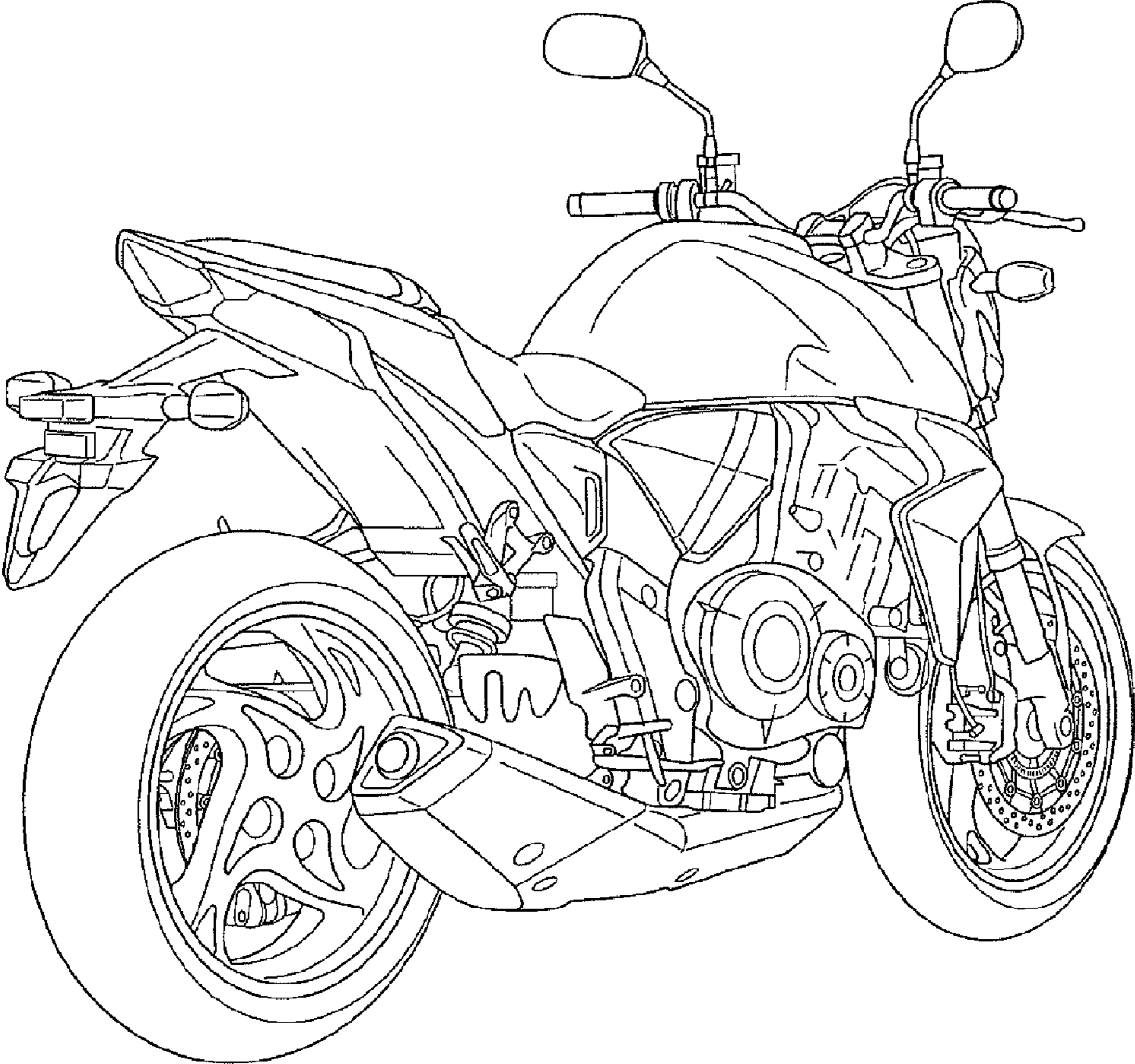

FIG. 5

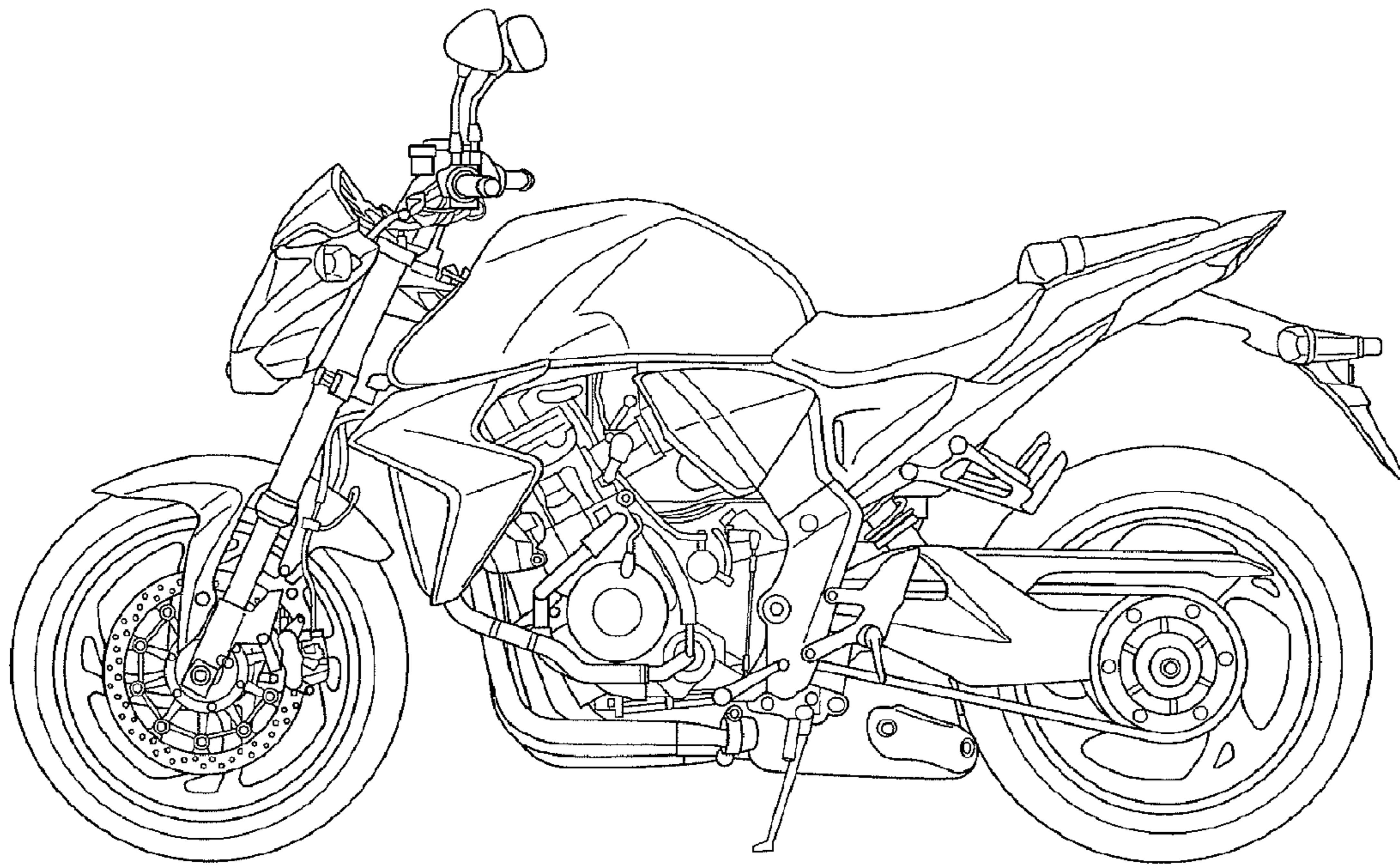

FIG. 6

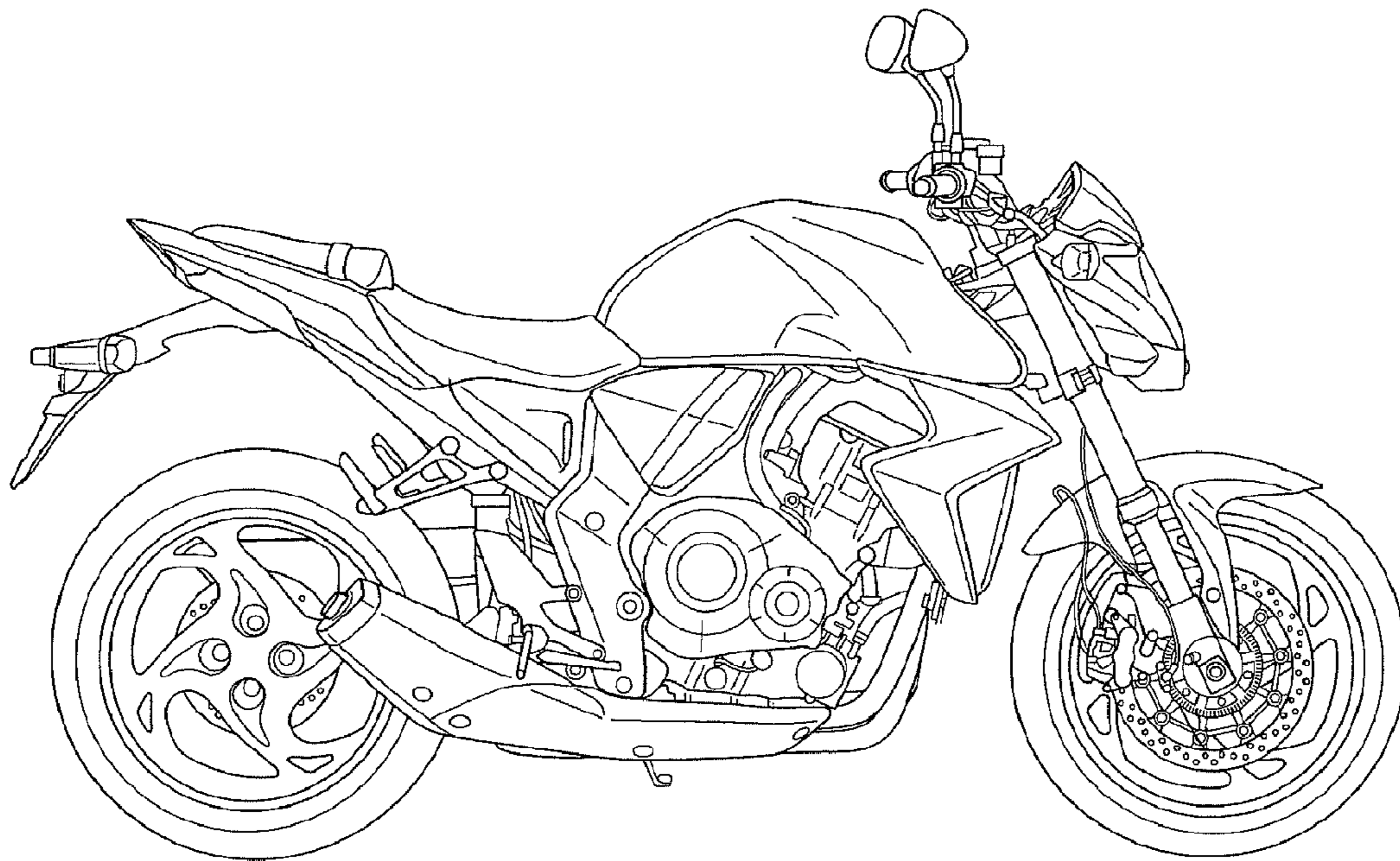

FIG. 7

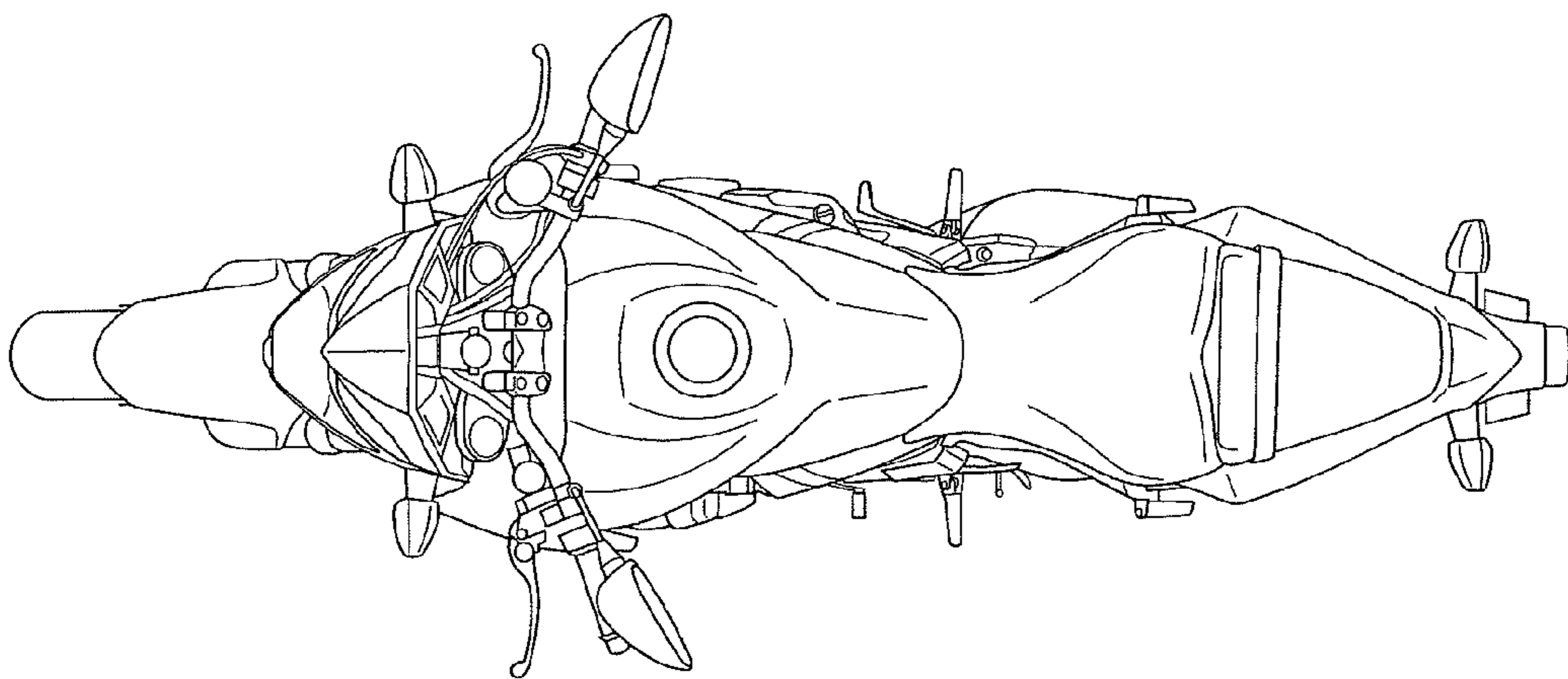



FIG. 8

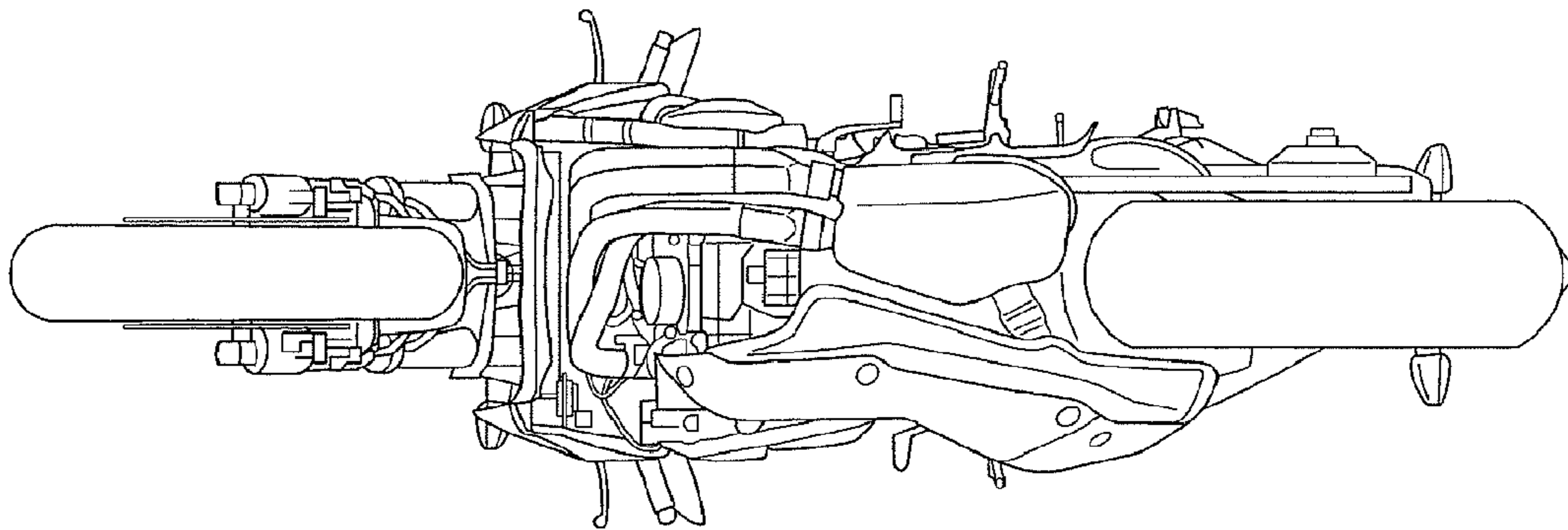

FIG. 9

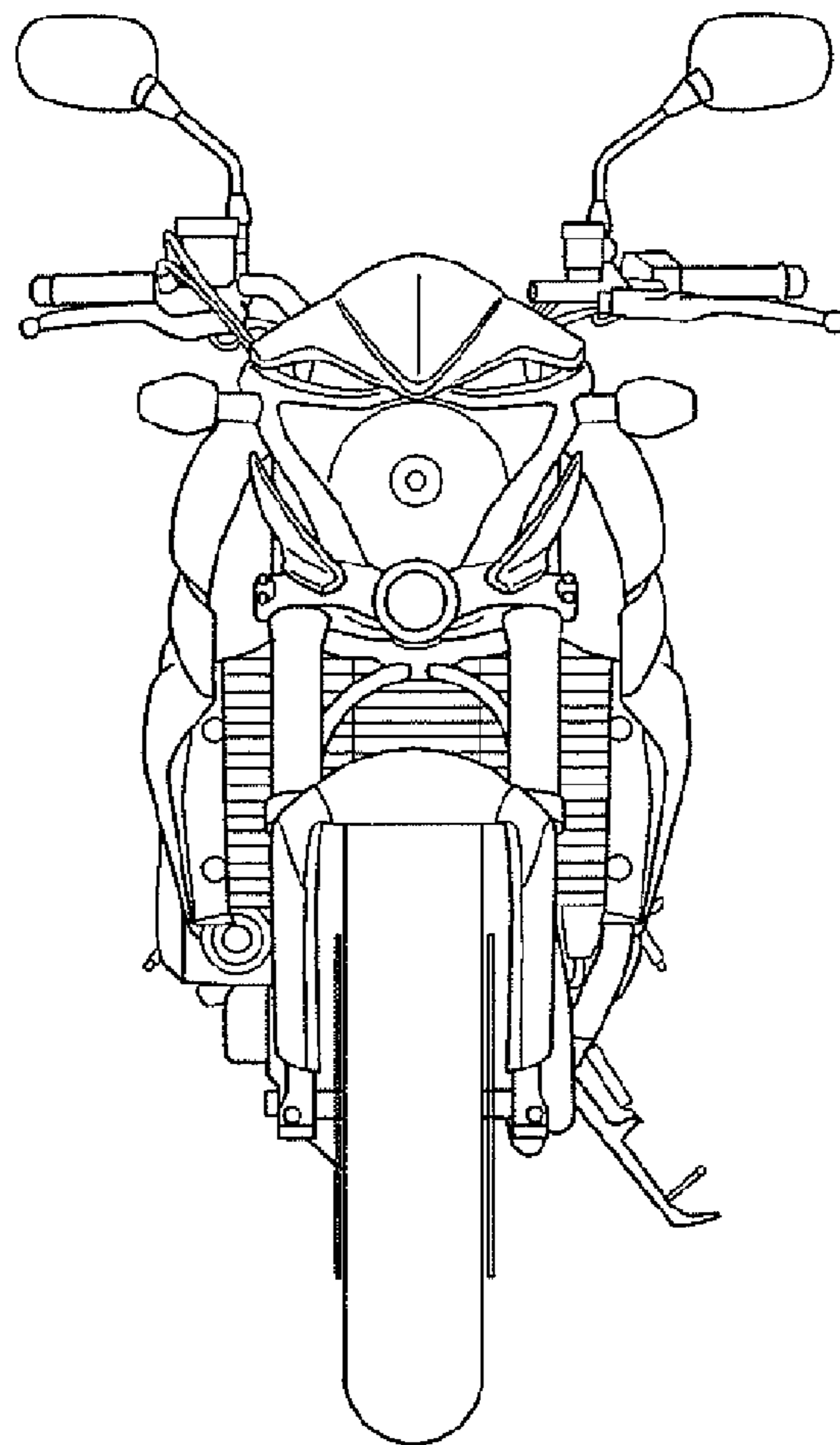

FIG. 10

