



US00D582295S

(12) **United States Design Patent**
Schoepfer

(10) **Patent No.:** **US D582,295 S**
(45) **Date of Patent:** **** Dec. 9, 2008**

(54) **WATCH CASE**

(75) Inventor: **Eddy Schoepfer**, Gorgier (CH)

(73) Assignee: **Breitling SA**, Grenchen (CH)

(**) Term: **14 Years**

(21) Appl. No.: **29/289,261**

(22) Filed: **Jul. 13, 2007**

(30) **Foreign Application Priority Data**

Feb. 14, 2007 (WO) DM/068573

(51) **LOC (8) Cl.** **10-02**

(52) **U.S. Cl.** **D10/38**

(58) **Field of Classification Search** D10/30-39;
368/276, 281, 282, 285, 288, 308, 319
See application file for complete search history.

(56) **References Cited**

U.S. PATENT DOCUMENTS

D77,439 S *	1/1929	Stegeman	D10/38
2,004,685 A *	6/1935	Best	24/265 WS
D244,761 S *	6/1977	Sulek	D10/38
D269,767 S *	7/1983	Houlihan et al.	D10/38
D278,130 S *	3/1985	Houlihan et al.	D10/38
D420,293 S *	2/2000	Parmigiani	D10/30
D444,077 S *	6/2001	Blondin	D10/39
D485,767 S *	1/2004	Lalo	D10/30
D490,000 S *	5/2004	Lassigne	D10/32
D491,473 S *	6/2004	Afshar	D10/32
D491,820 S *	6/2004	Bitetto	D10/39

D493,111 S *	7/2004	Afshar	D10/32
D494,072 S *	8/2004	Bitetto	D10/39
D494,477 S *	8/2004	Lalo	D10/30
D505,340 S *	5/2005	Lalo	D10/30
D508,421 S *	8/2005	Diltoer	D10/39
D510,707 S *	10/2005	Cheng	D10/30
D524,175 S *	7/2006	Zanette	D10/38
D531,524 S *	11/2006	Behling	D10/38
D548,625 S *	8/2007	Schoepfer et al.	D10/39
D564,370 S *	3/2008	Bove et al.	D10/38
D564,908 S *	3/2008	Chodat	D10/38

* cited by examiner

Primary Examiner—Lucy Lieberman

(74) *Attorney, Agent, or Firm*—Gottlieb, Rackman & Reisman

(57) **CLAIM**

The ornamental design for a watch case, as shown.

DESCRIPTION

FIG. 1 is a front elevation of a watch case showing my new design;

FIG. 2 is a rear elevation thereof;

FIG. 3 is a perspective view thereof;

FIG. 4 is a left side elevational view thereof;

FIG. 5 is a right side elevational view thereof;

FIG. 6 is a bottom plan view thereof; and,

FIG. 7 is a top plan view thereof.

1 Claim, 5 Drawing Sheets

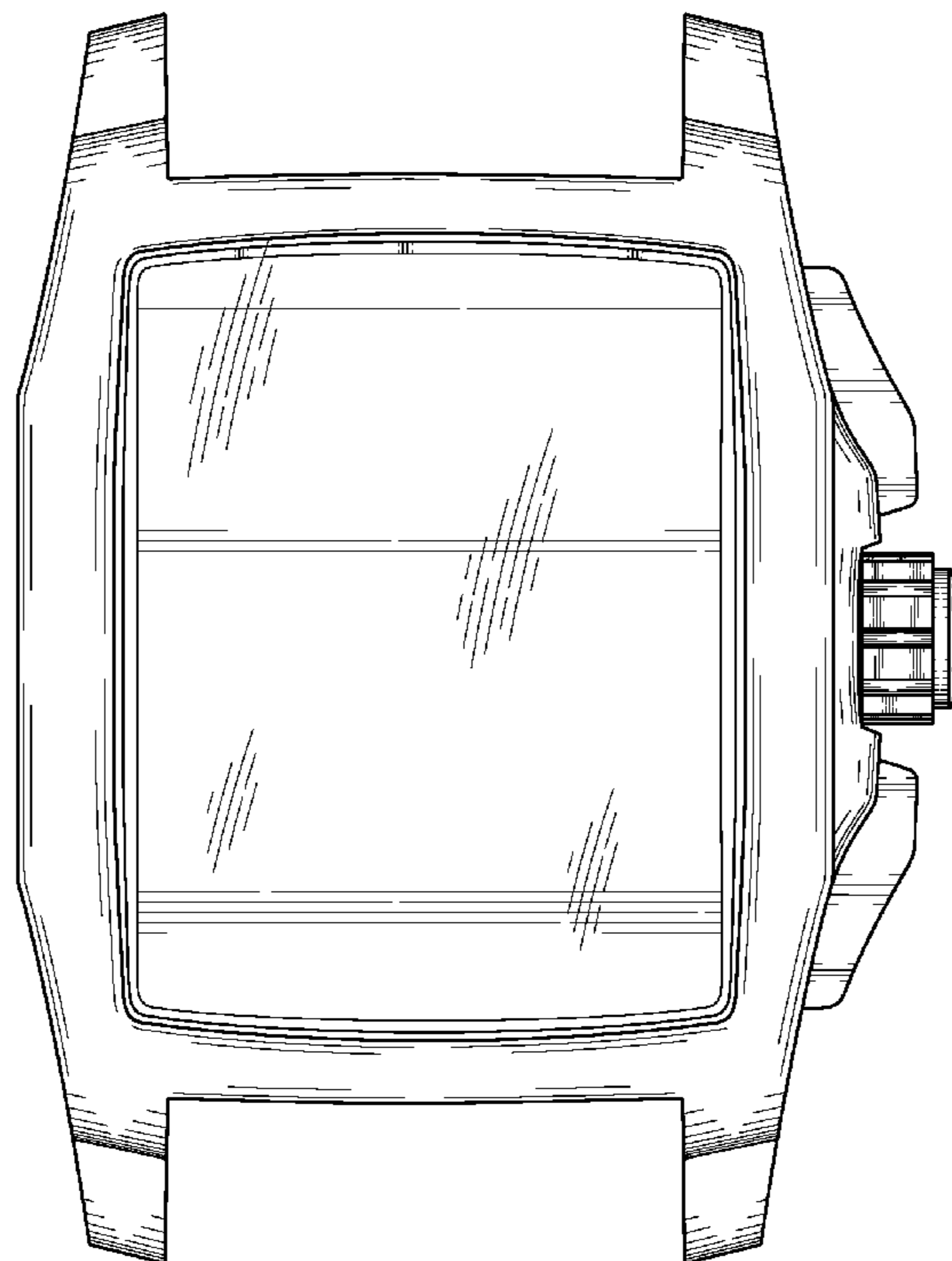

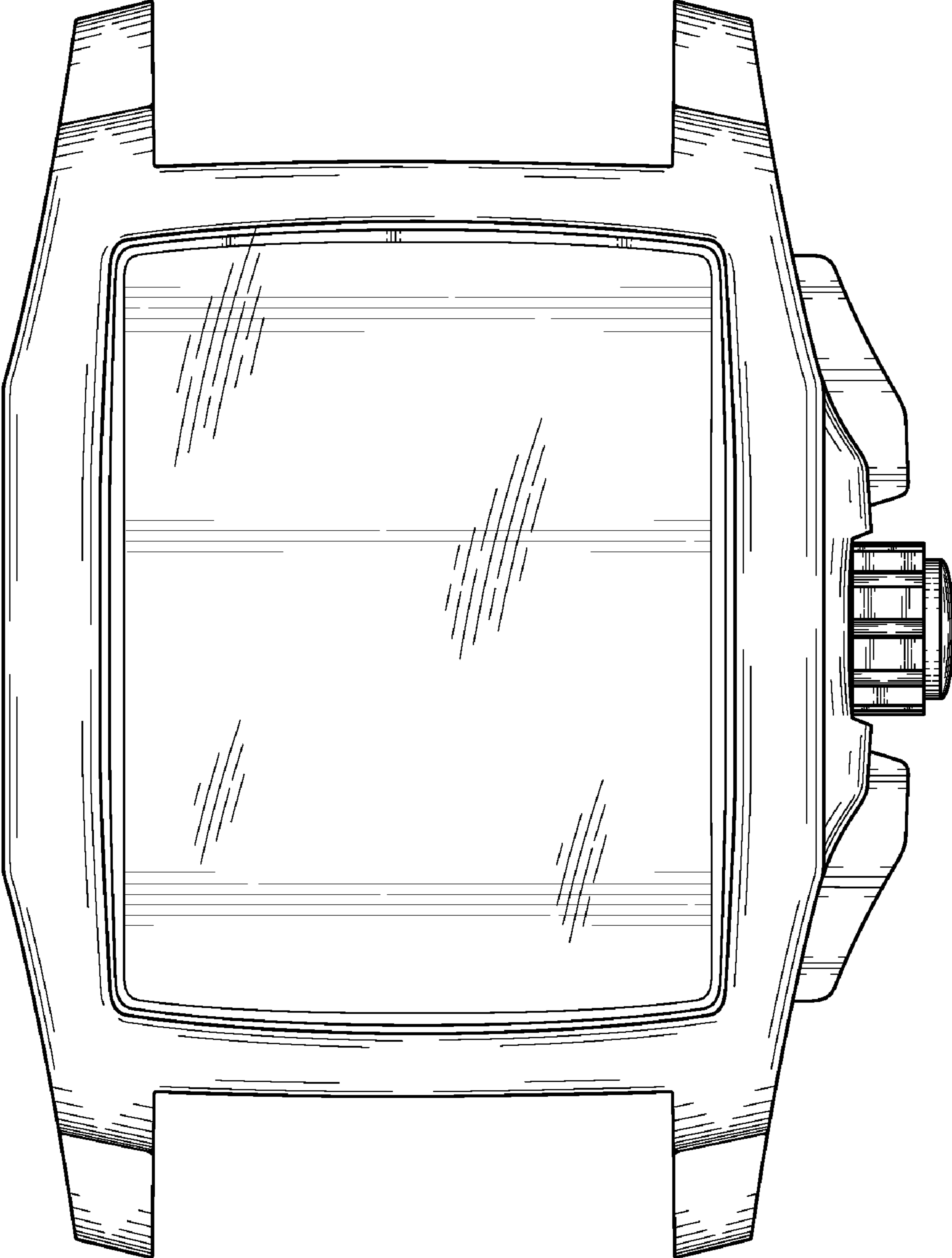

FIG. 1

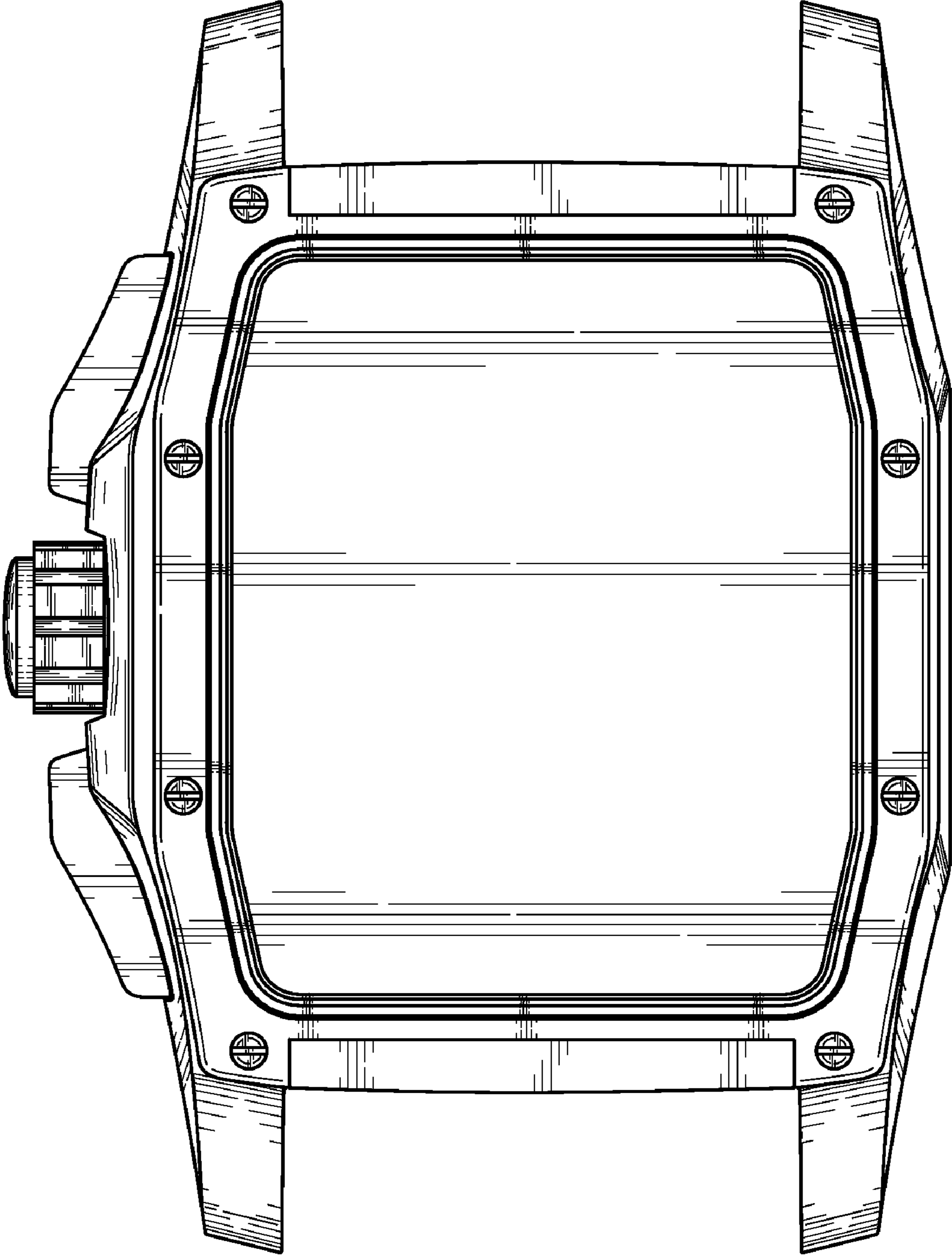

FIG. 2

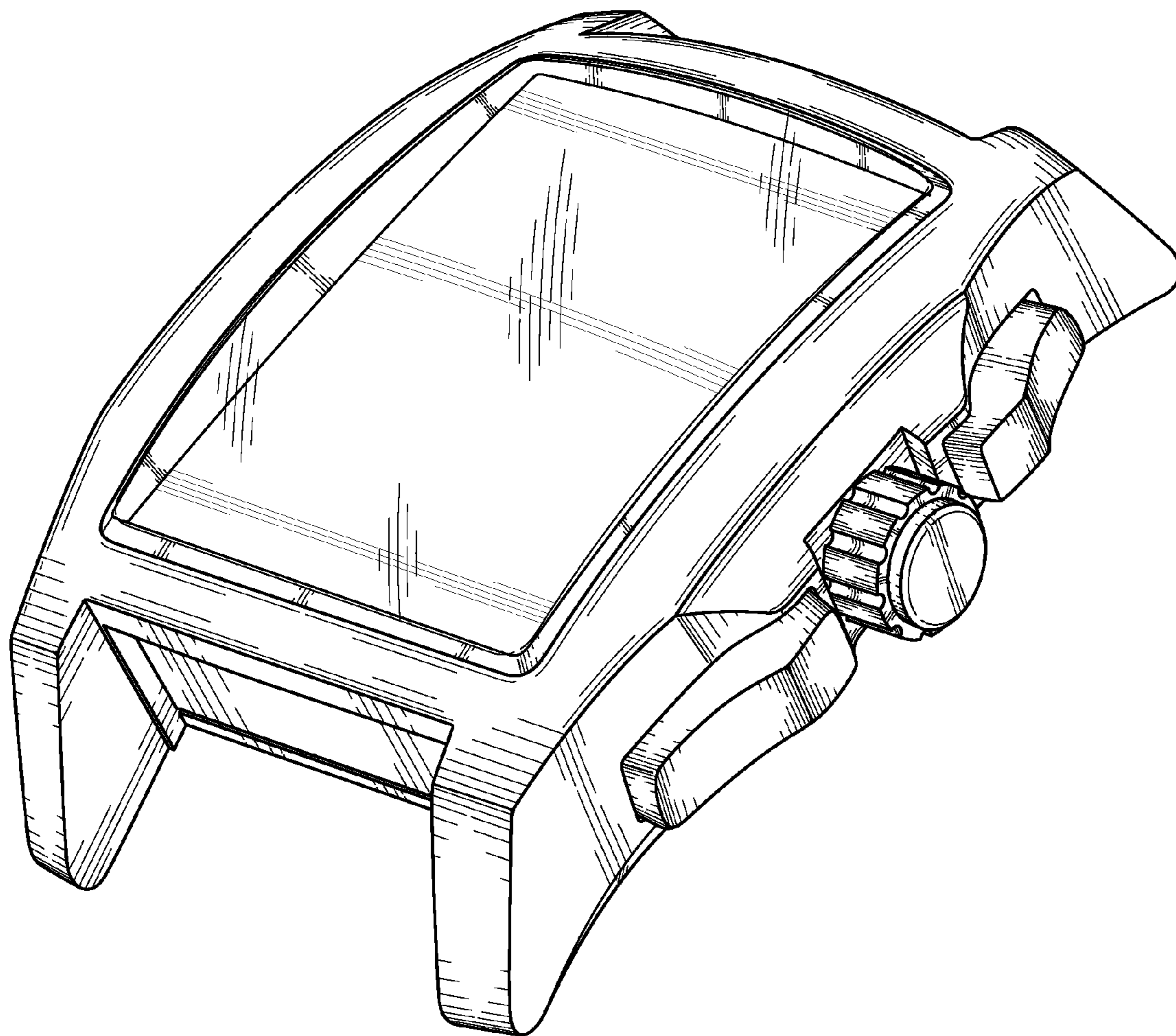

FIG. 3

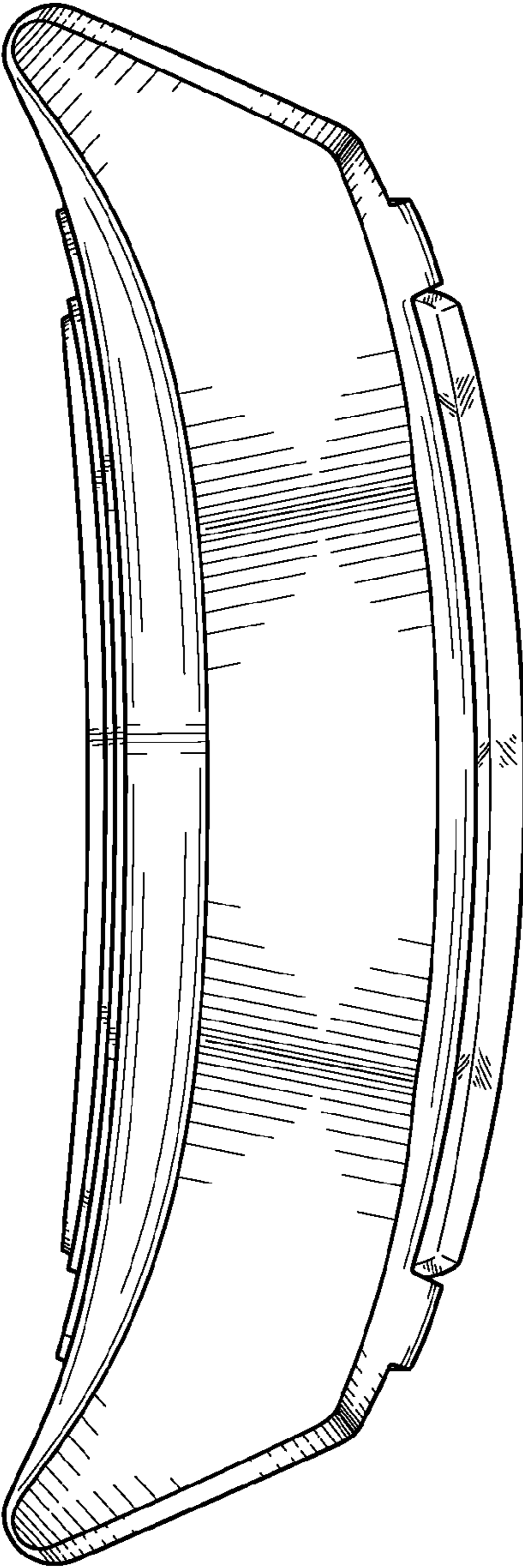

FIG. 4

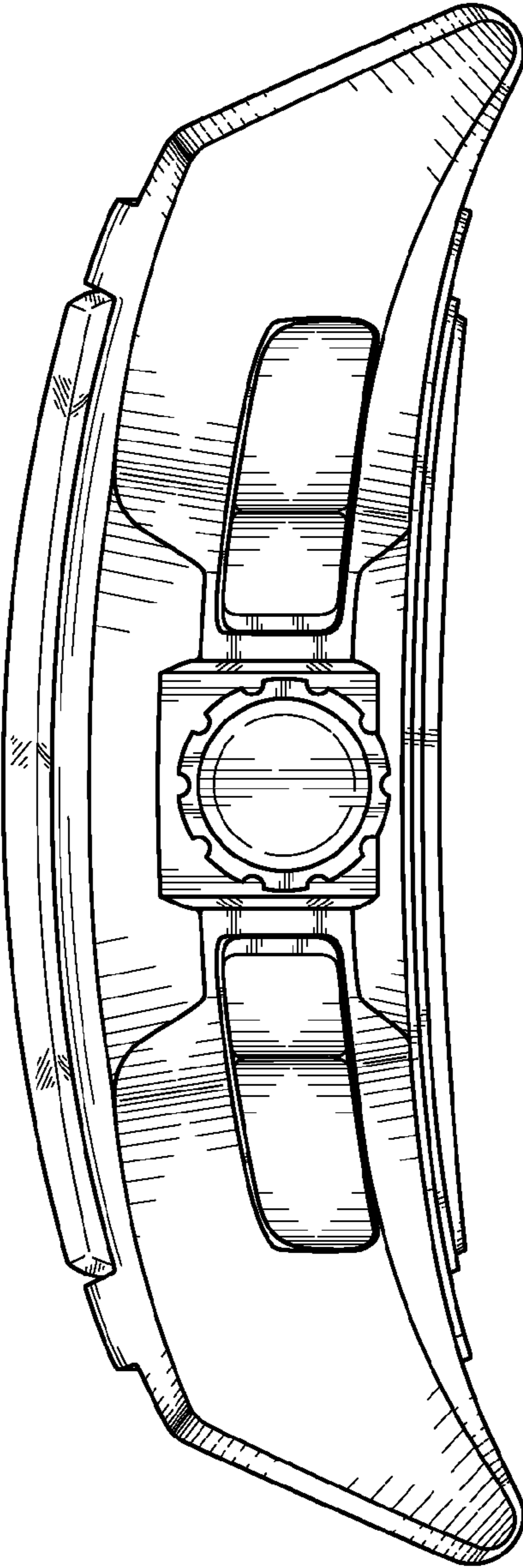

FIG. 5

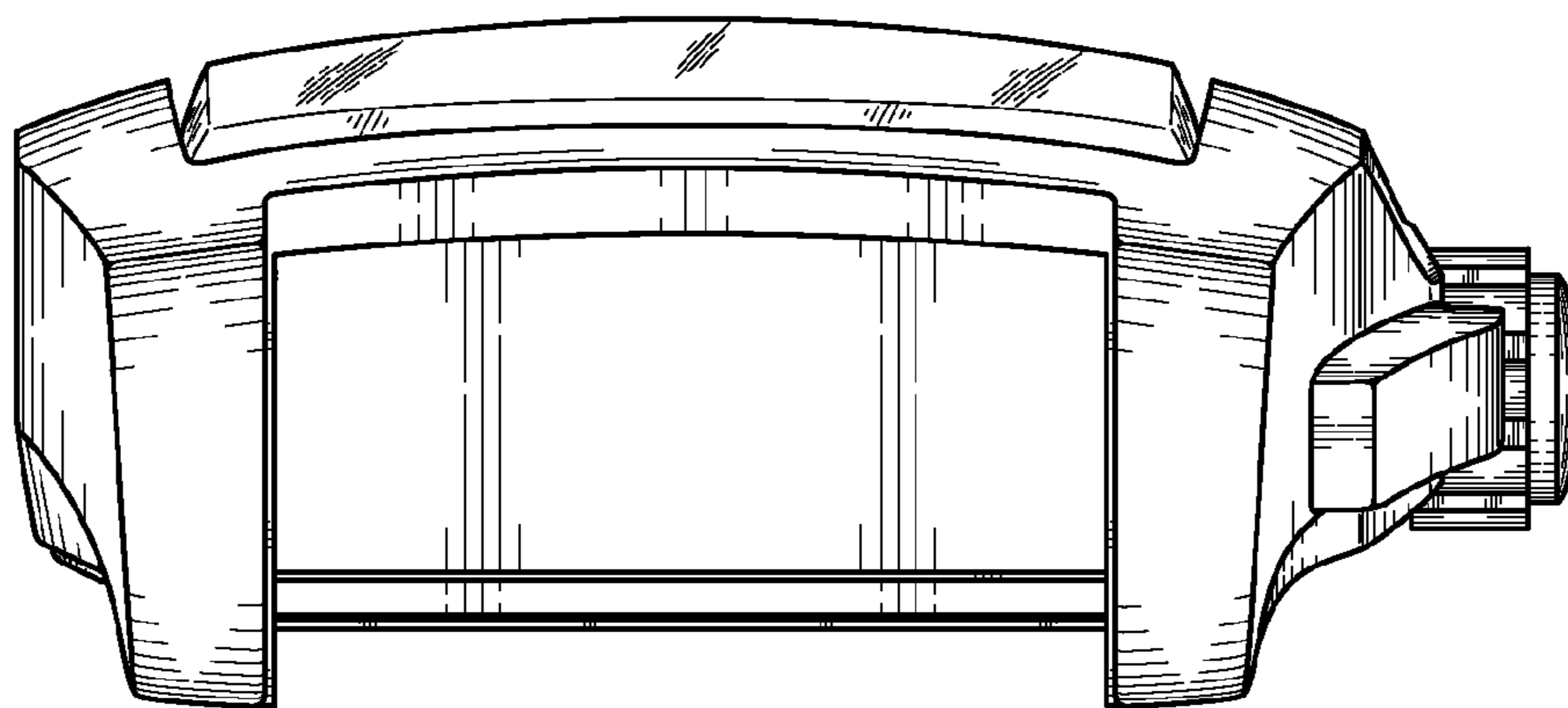

FIG. 6

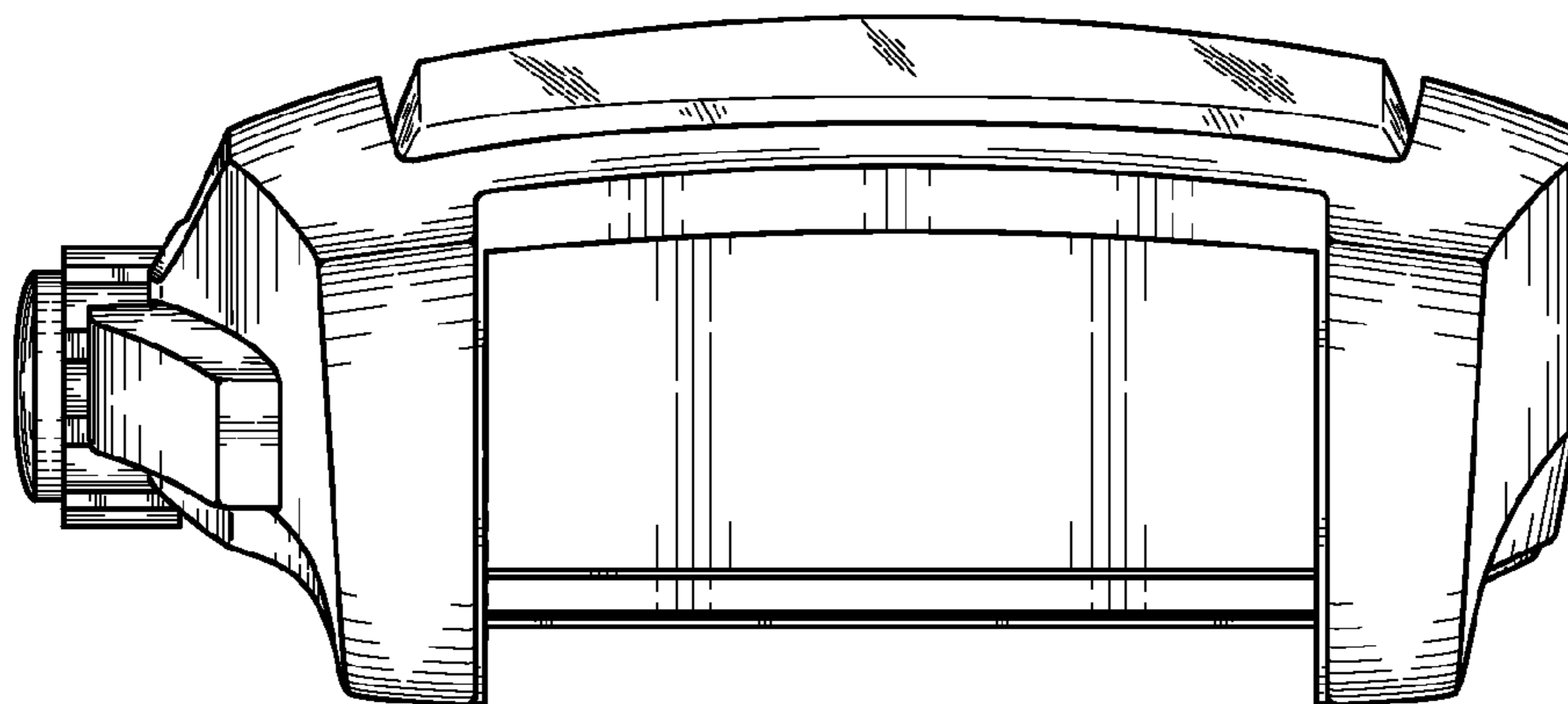

FIG. 7