



US00D582292S

(12) **United States Design Patent**  
**Short et al.**

(10) **Patent No.:** **US D582,292 S**  
(45) **Date of Patent:** **\*\* Dec. 9, 2008**

(54) **CONTAINER**

(75) Inventors: **Martin Short**, Jersey City, NJ (US);  
**Robert Croft**, Jersey City, NJ (US)

(73) Assignee: **Purdue Pharma L.P.**, Stamford, CT  
(US)

(\*\*) Term: **14 Years**

(21) Appl. No.: **29/281,814**

(22) Filed: **Jul. 2, 2007**

(51) **LOC (8) Cl.** ..... **09-01**

(52) **U.S. Cl.** ..... **D9/561; D9/571; D9/435**

(58) **Field of Classification Search** ..... D9/516,  
D9/522, 529, 544, 561, 571, 575, 443-446;  
D24/117; 215/382-384, 396, 398; 220/915,  
220/726

See application file for complete search history.

(56) **References Cited**

**U.S. PATENT DOCUMENTS**

D25,355 S *	4/1896	Smalley	.....	D9/522
D85,067 S *	9/1931	Sterrett	.....	D9/561
D88,110 S *	10/1932	Scurlock	.....	D9/522
D210,115 S *	2/1968	Armour	.....	D9/529
D330,677 S *	11/1992	Thornock et al.	.....	D9/558
D346,115 S *	4/1994	Meisner et al.	.....	D9/529
D459,229 S *	6/2002	Paul	.....	D9/529
D468,209 S *	1/2003	Joubert	.....	D9/529
D478,819 S *	8/2003	Pfaeffli et al.	.....	D9/559
D497,038 S *	10/2004	Tsai	.....	D9/561 X
D523,750 S *	6/2006	Lee et al.	.....	D9/549
D537,492 S *	2/2007	Paolucci et al.	.....	D21/707
D539,651 S *	4/2007	Snyder	.....	D9/520
D541,159 S *	4/2007	Robinson	.....	D9/516

D548,607 S *	8/2007	Langbein et al.	.....	D9/560
D558,583 S *	1/2008	Langbein et al.	.....	D9/560
D564,884 S *	3/2008	Rittman	.....	D9/522

\* cited by examiner

*Primary Examiner*—Carol Rademaker

(74) *Attorney, Agent, or Firm*—Sterne, Kessler, Goldstein & Fox P.L.L.C.

(57) **CLAIM**

The ornamental design for a container, as shown and described.

**DESCRIPTION**

FIG. 1 is a top, front perspective view of a first embodiment of a container showing a new design;

FIG. 2 is a front elevational view thereof;

FIG. 3 is a rear elevational view thereof;

FIG. 4 is a left side elevational view thereof;

FIG. 5 is a right side elevational view thereof;

FIG. 6 is a top plan view thereof;

FIG. 7 is a bottom plan view thereof;

FIG. 8 is a top, front perspective view of a second embodiment of a container showing the new design;

FIG. 9 is a front elevational view thereof;

FIG. 10 is a rear elevational view thereof;

FIG. 11 is a left side elevational view thereof;

FIG. 12 is a right side elevational view thereof;

FIG. 13 is a top plan view thereof; and,

FIG. 14 is a bottom plan view thereof.

**1 Claim, 12 Drawing Sheets**

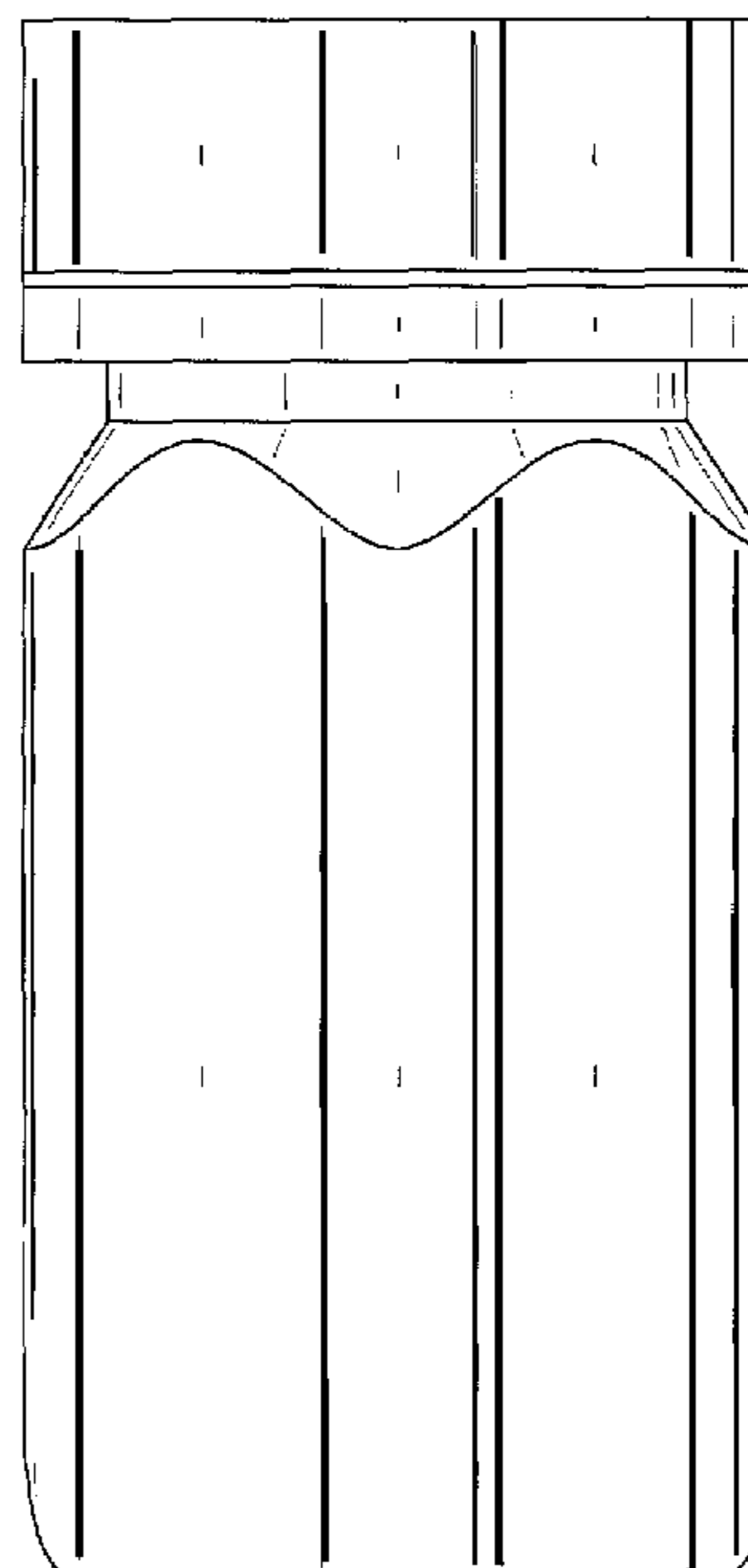
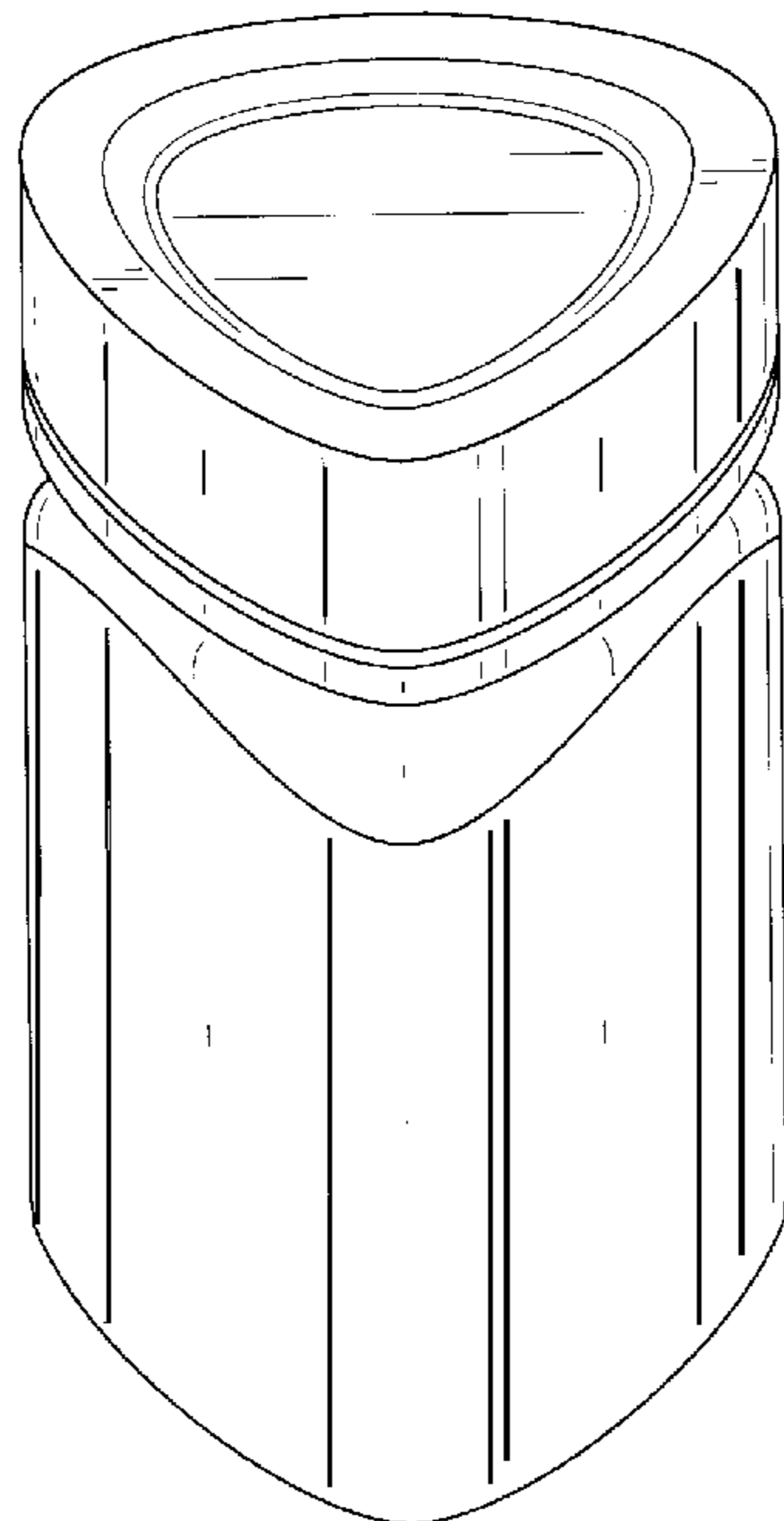

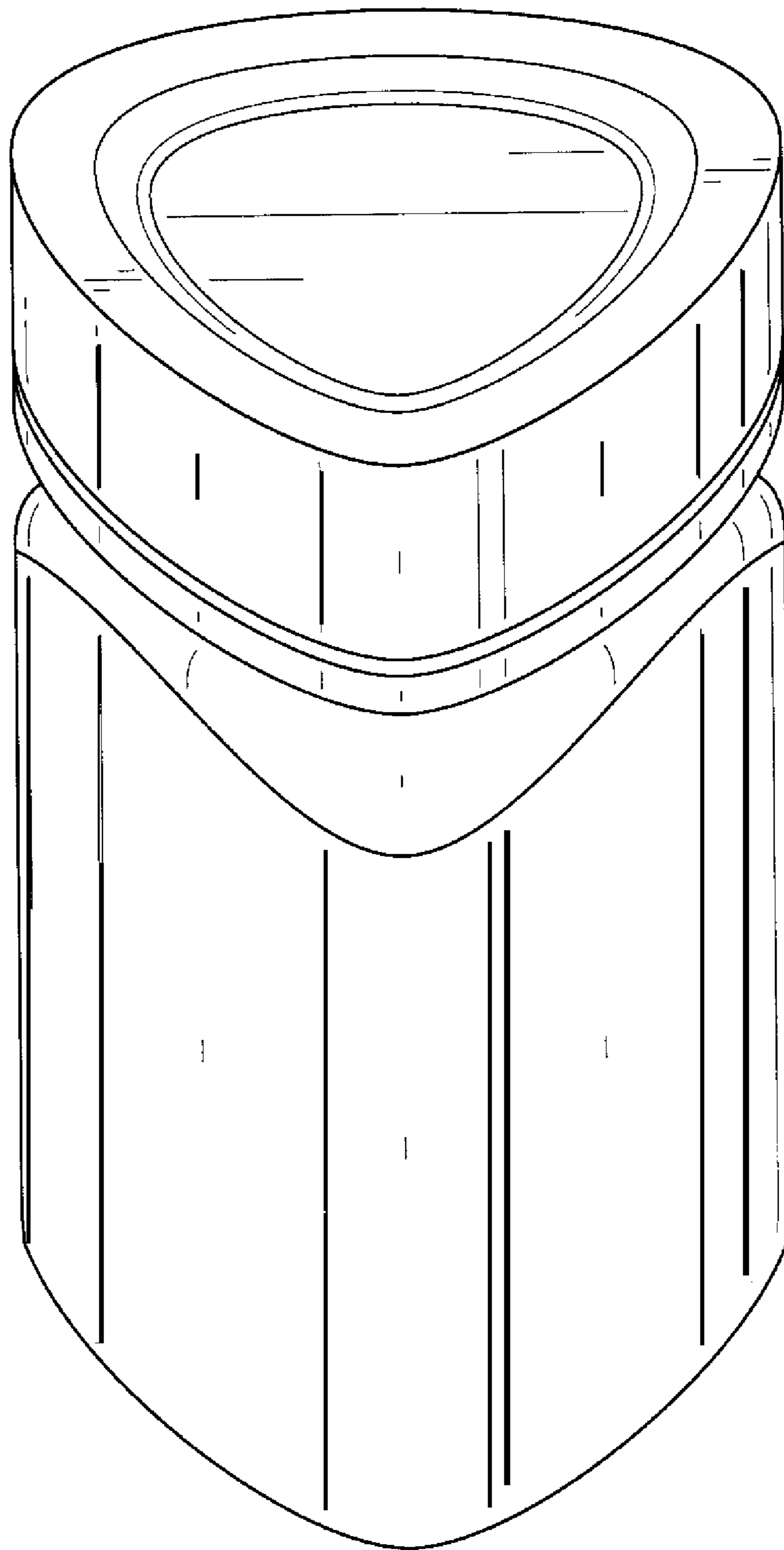

FIG. 1

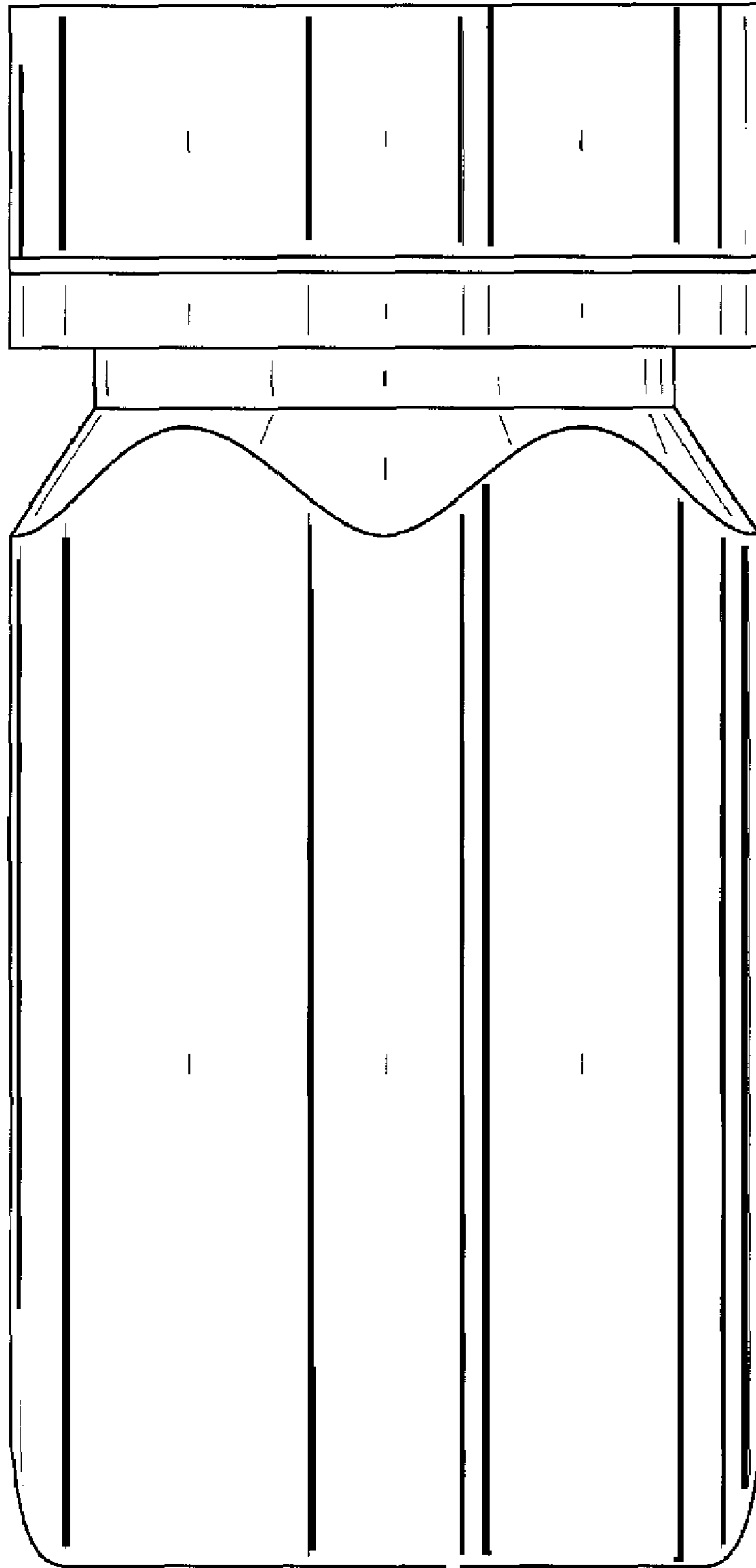

FIG. 2

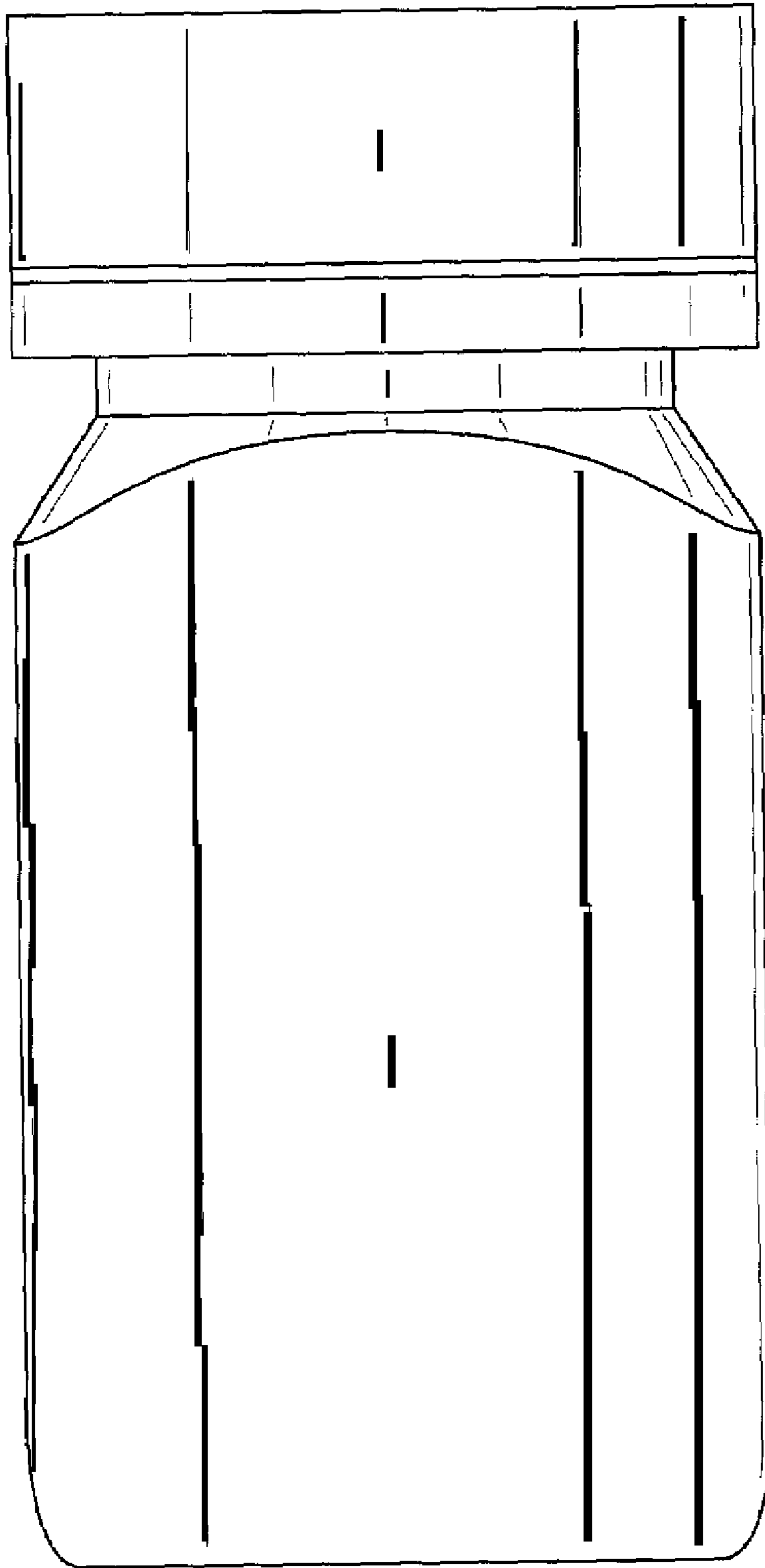

FIG. 3

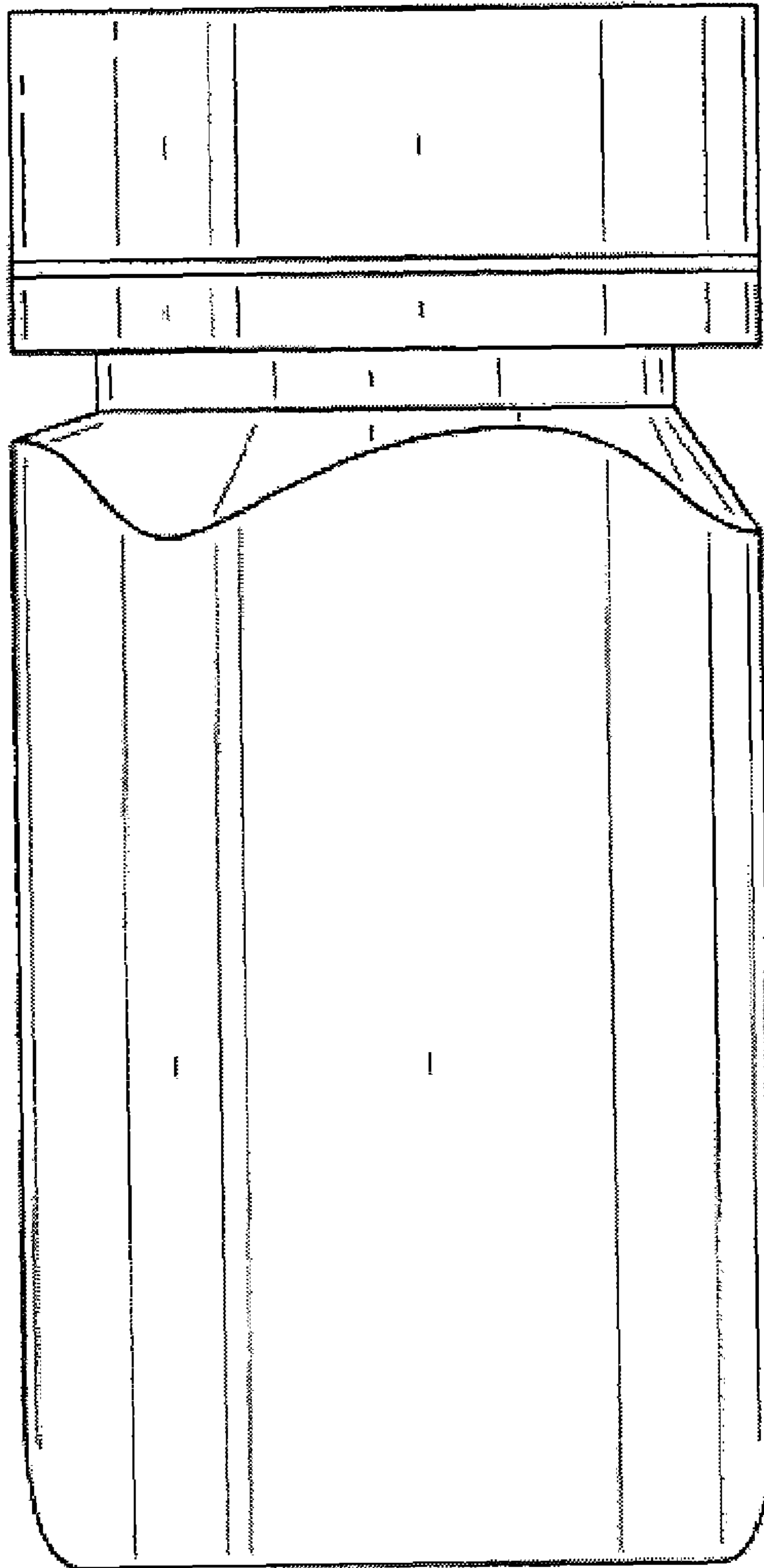

FIG. 4

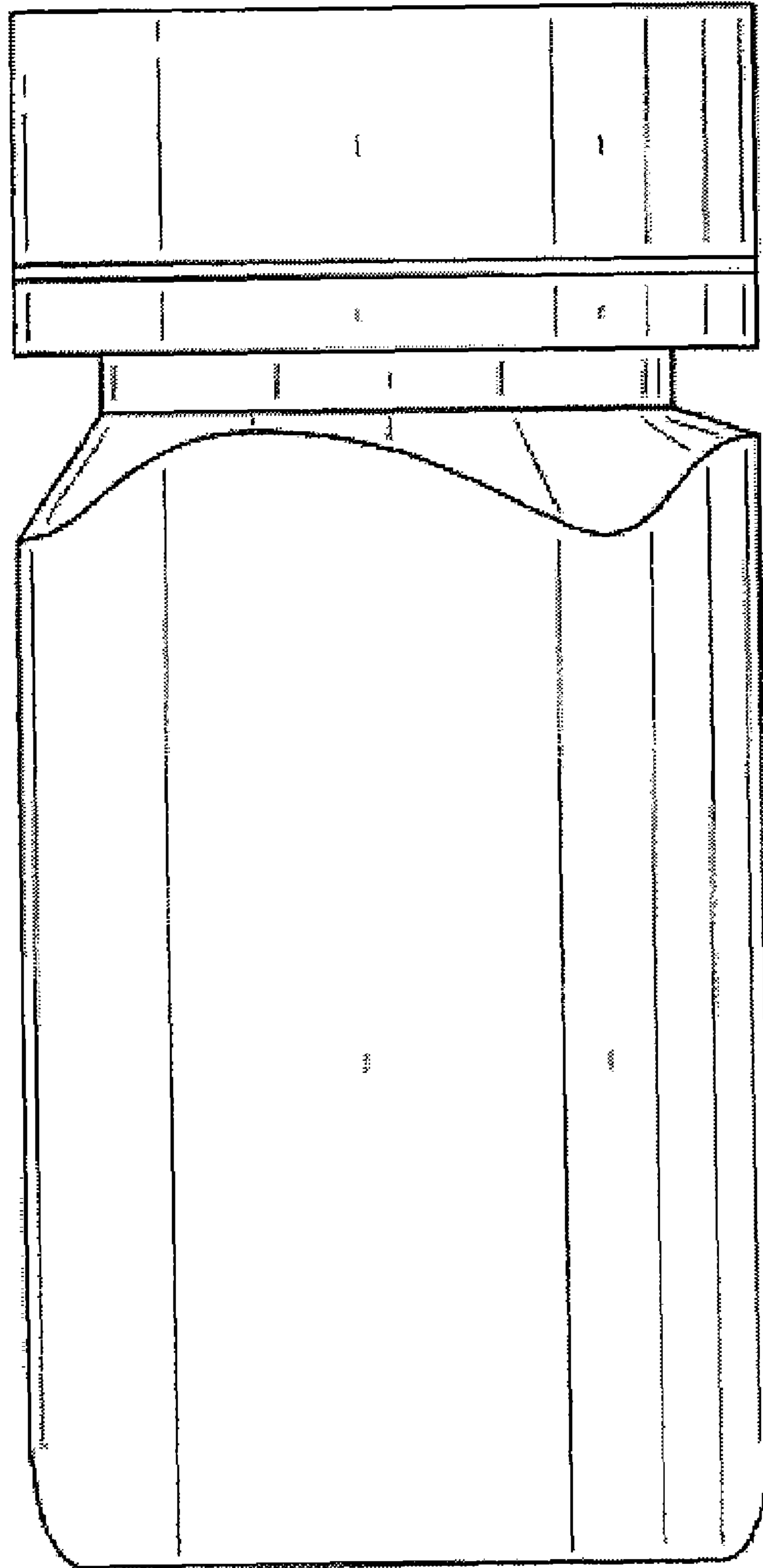

FIG. 5

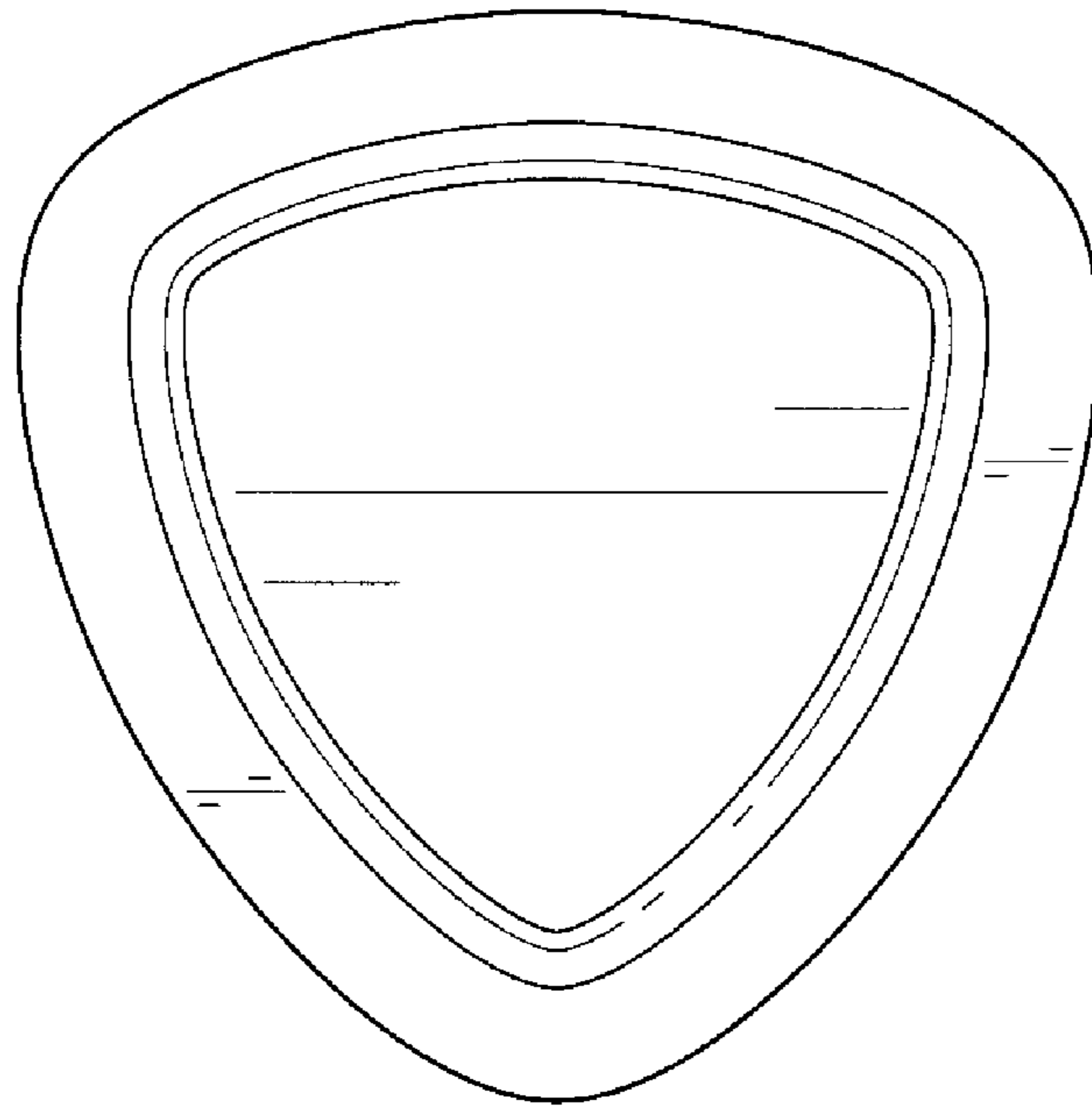

FIG. 6

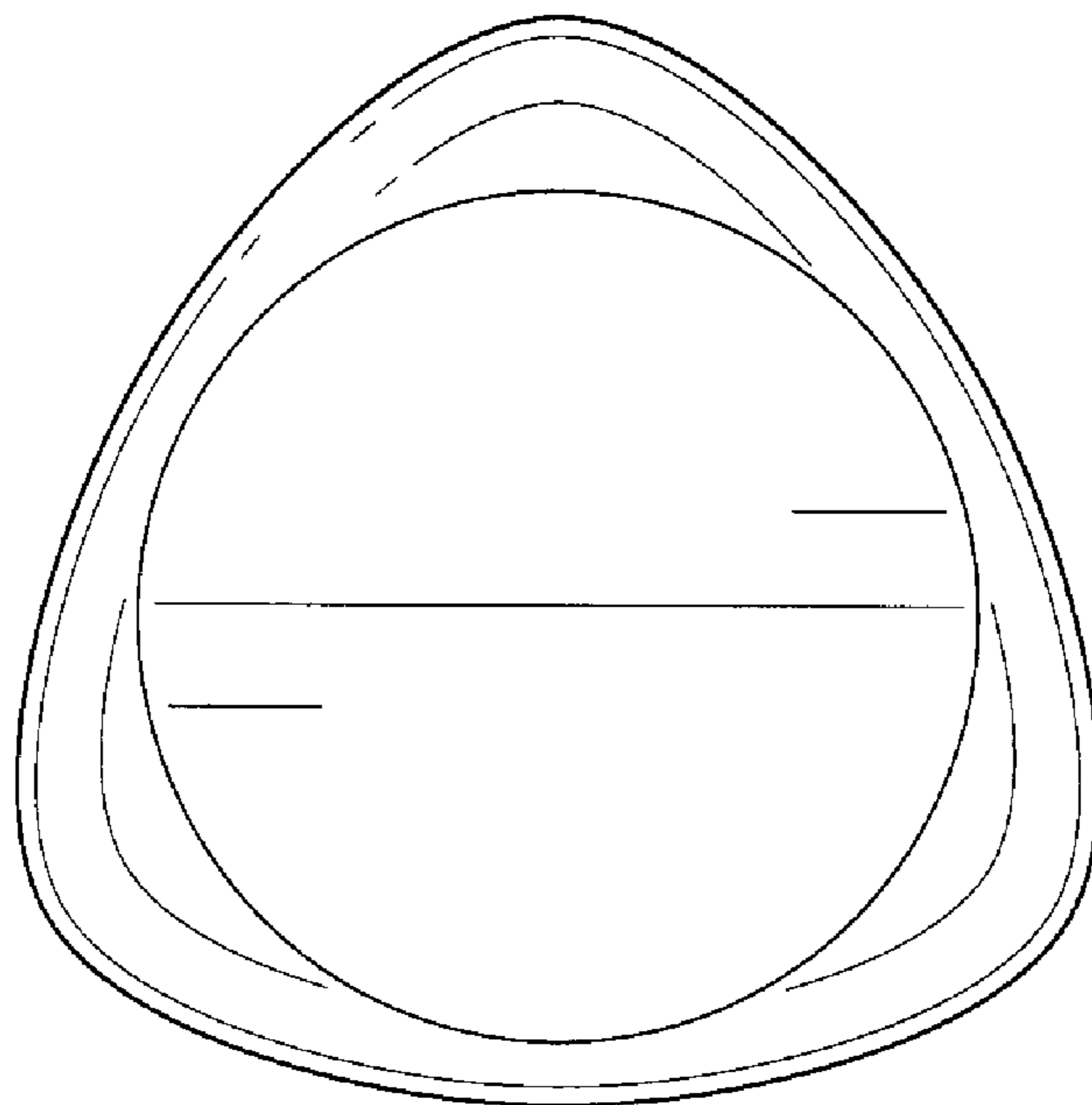

FIG. 7

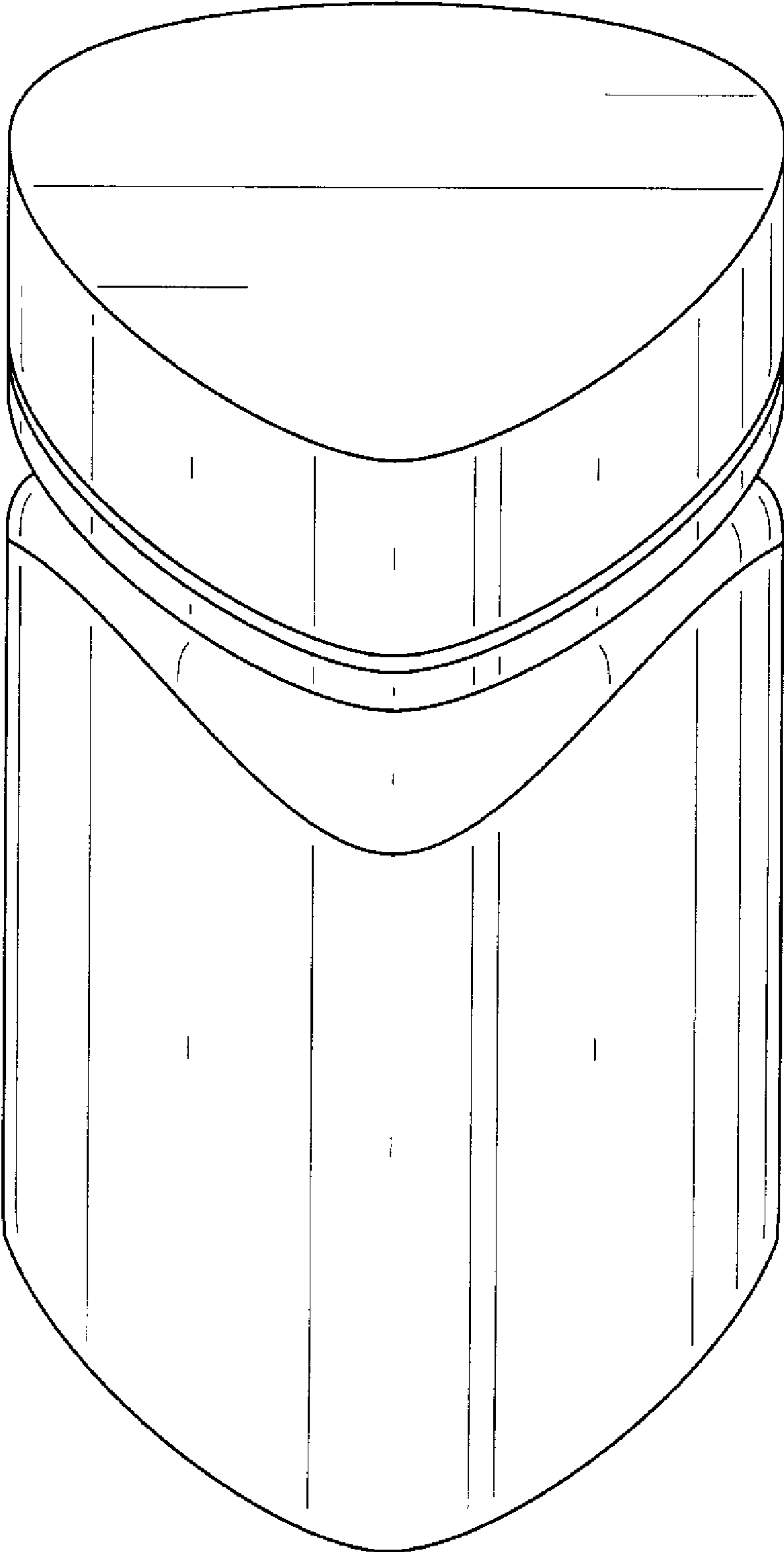

FIG. 8



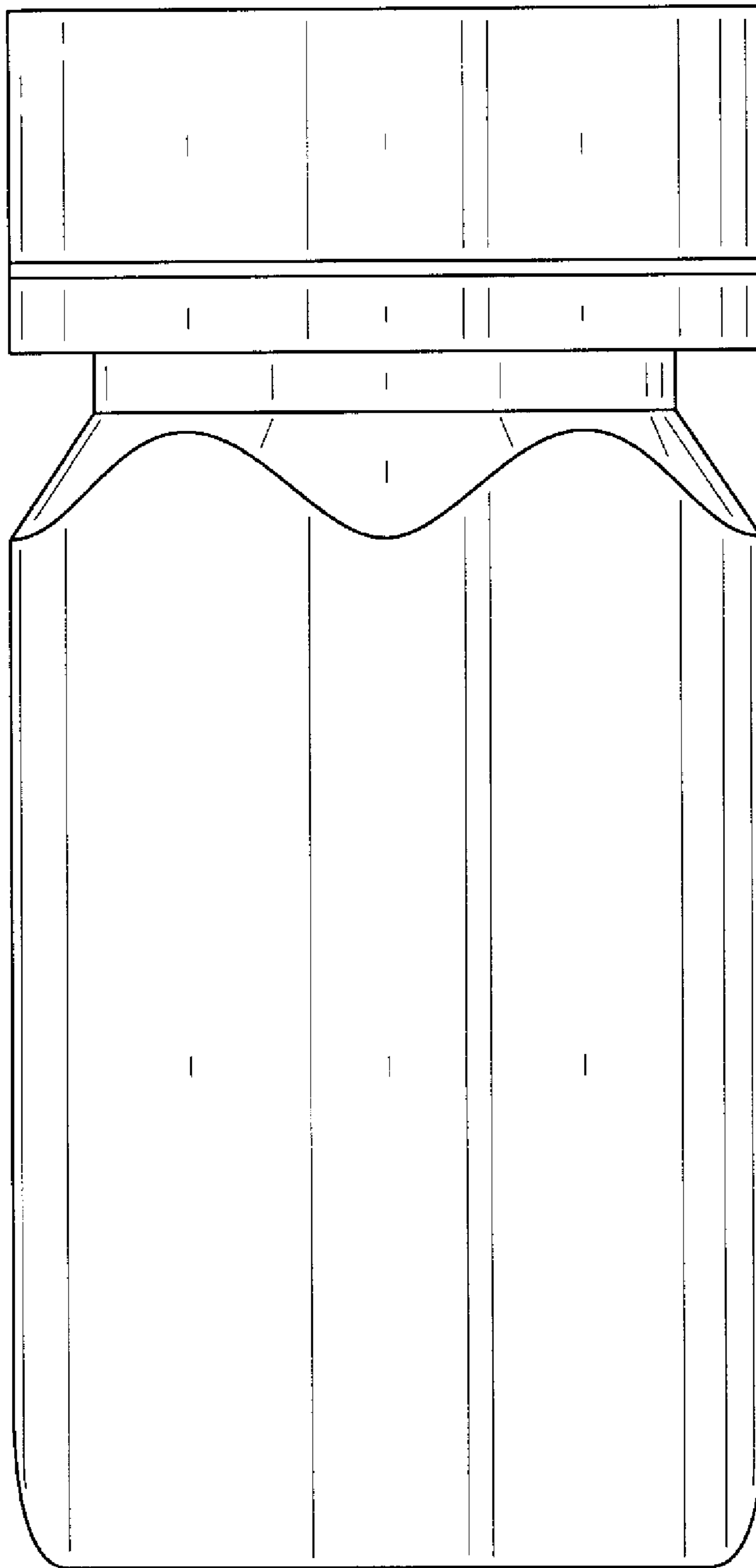

FIG. 9

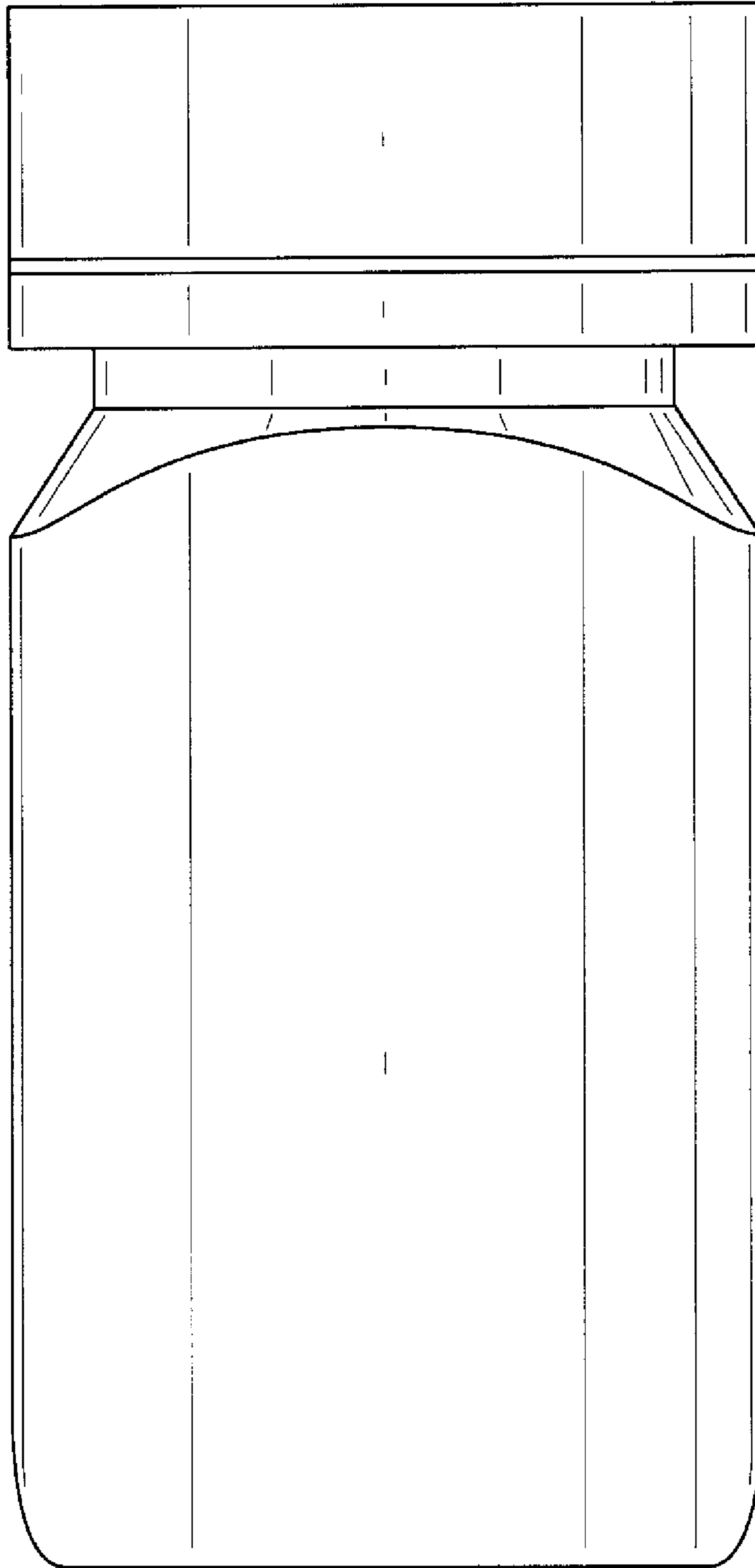

FIG. 10

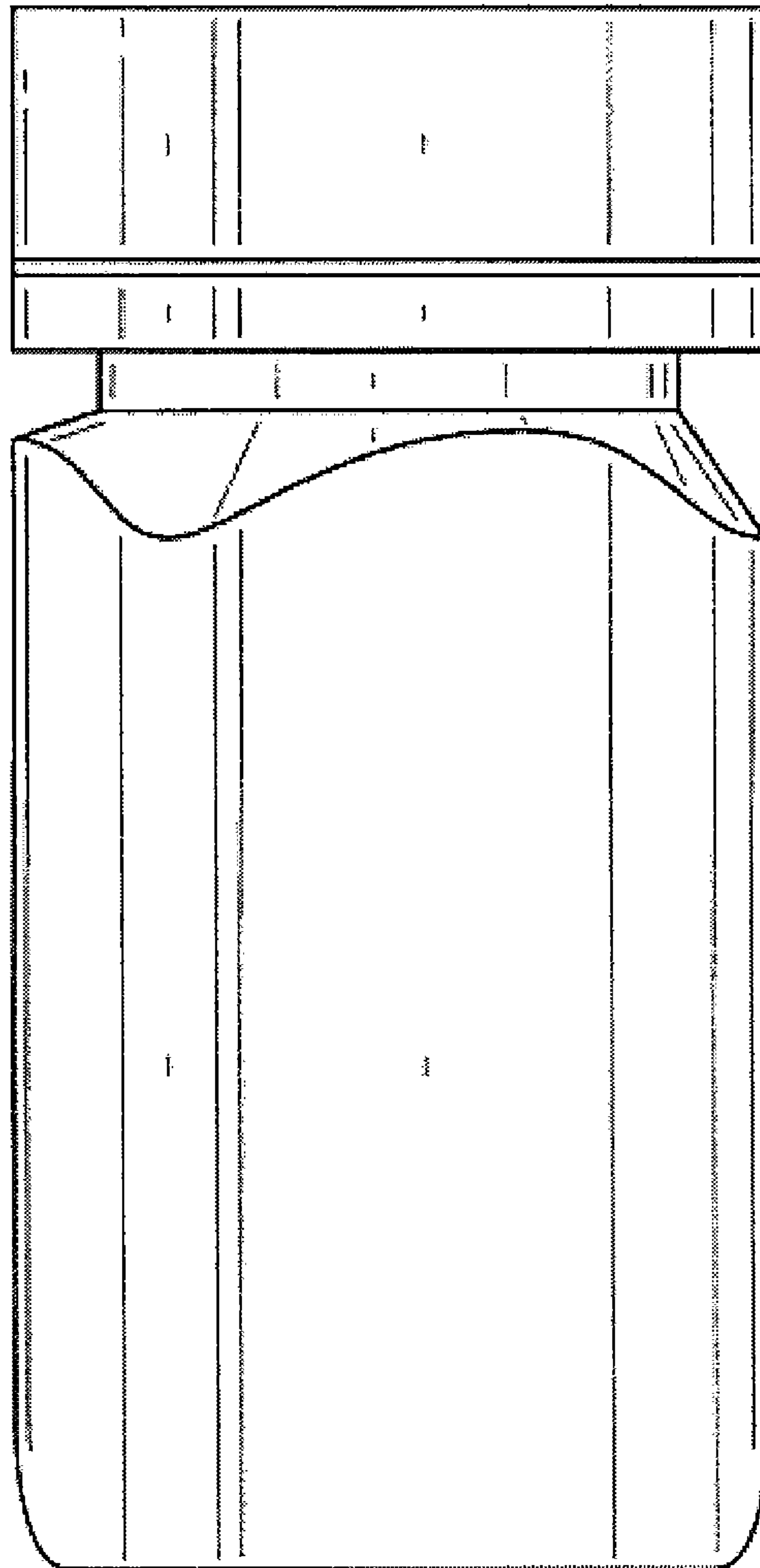

FIG. 11

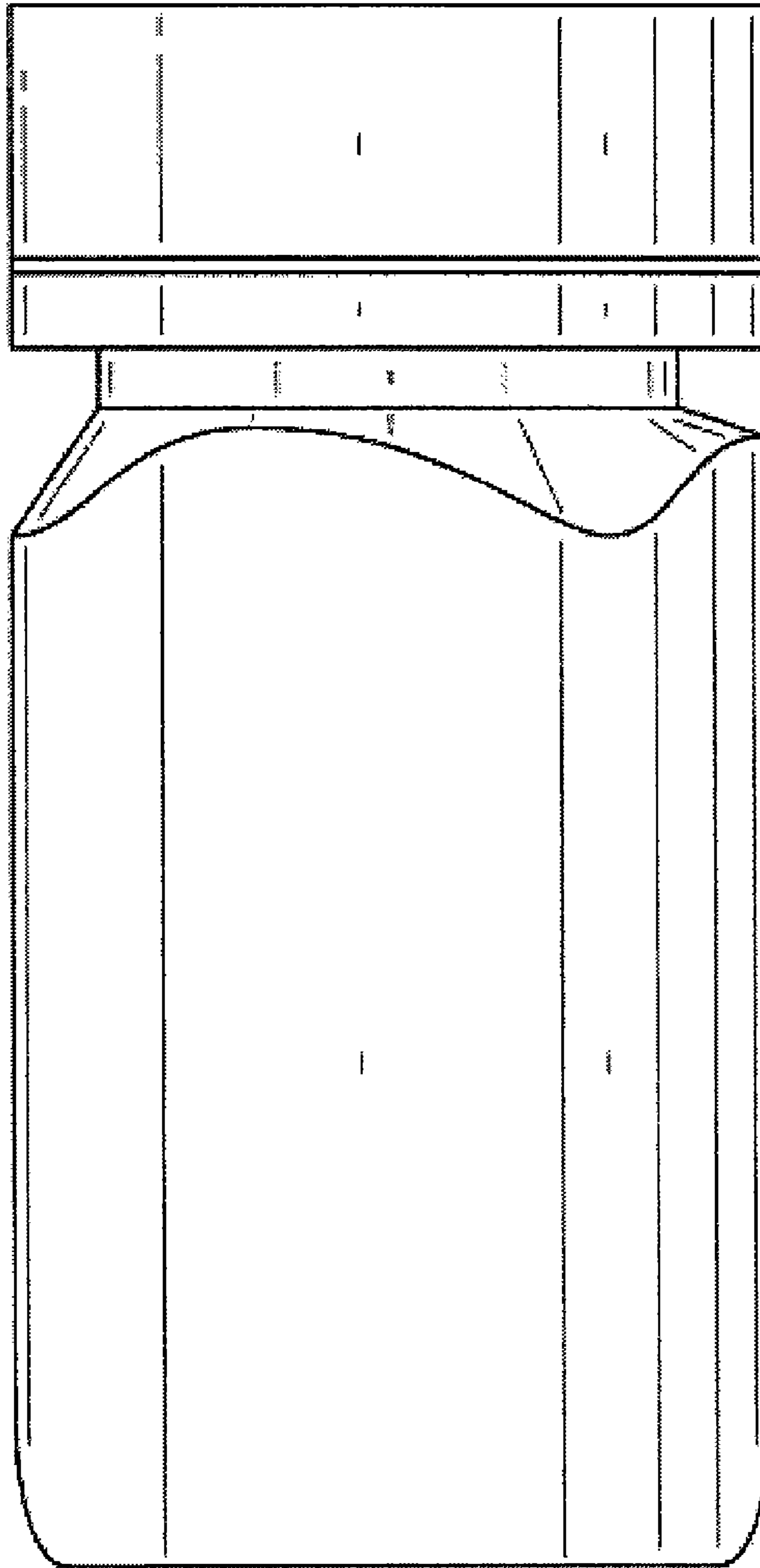

FIG. 12

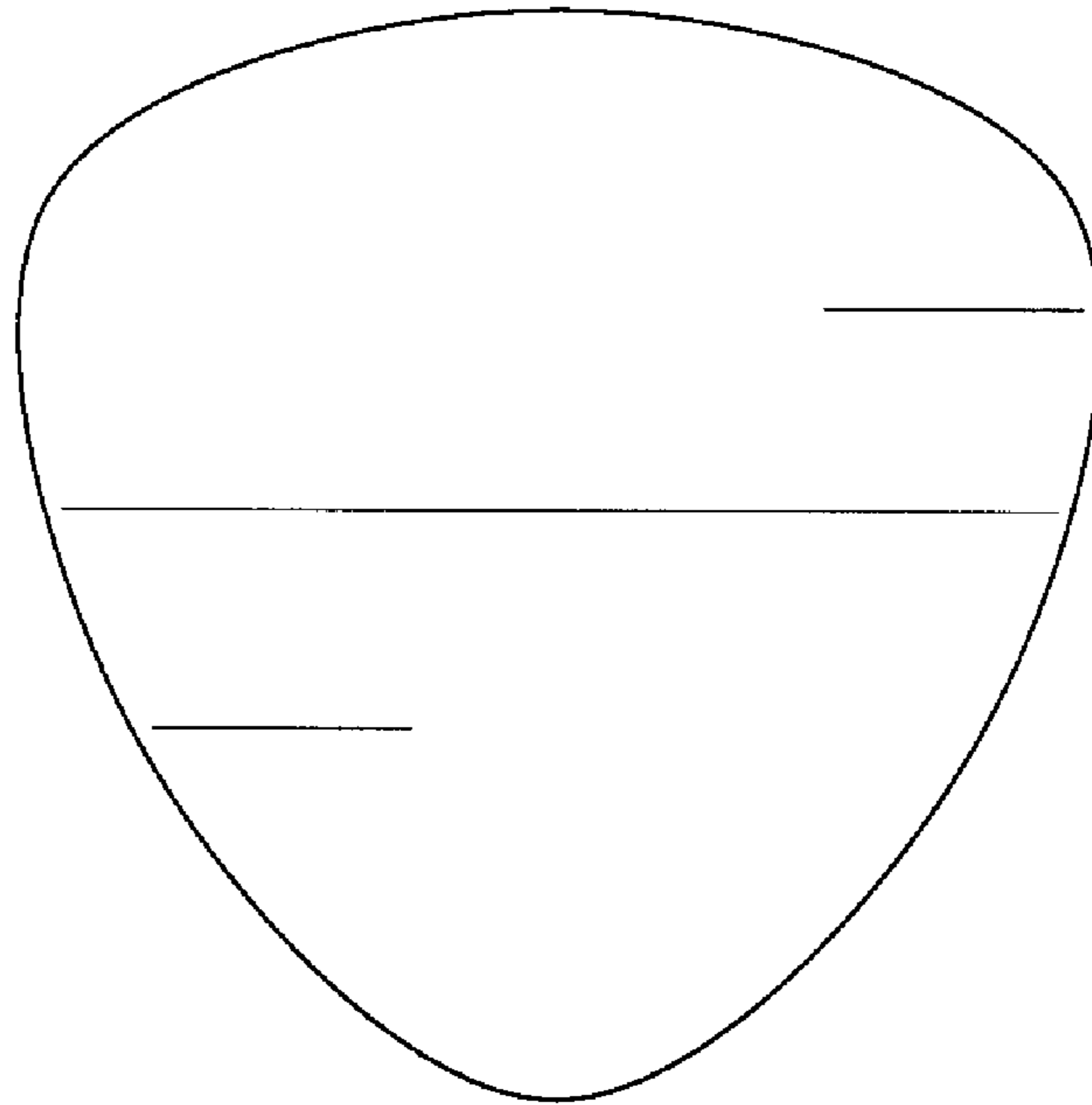

FIG. 13

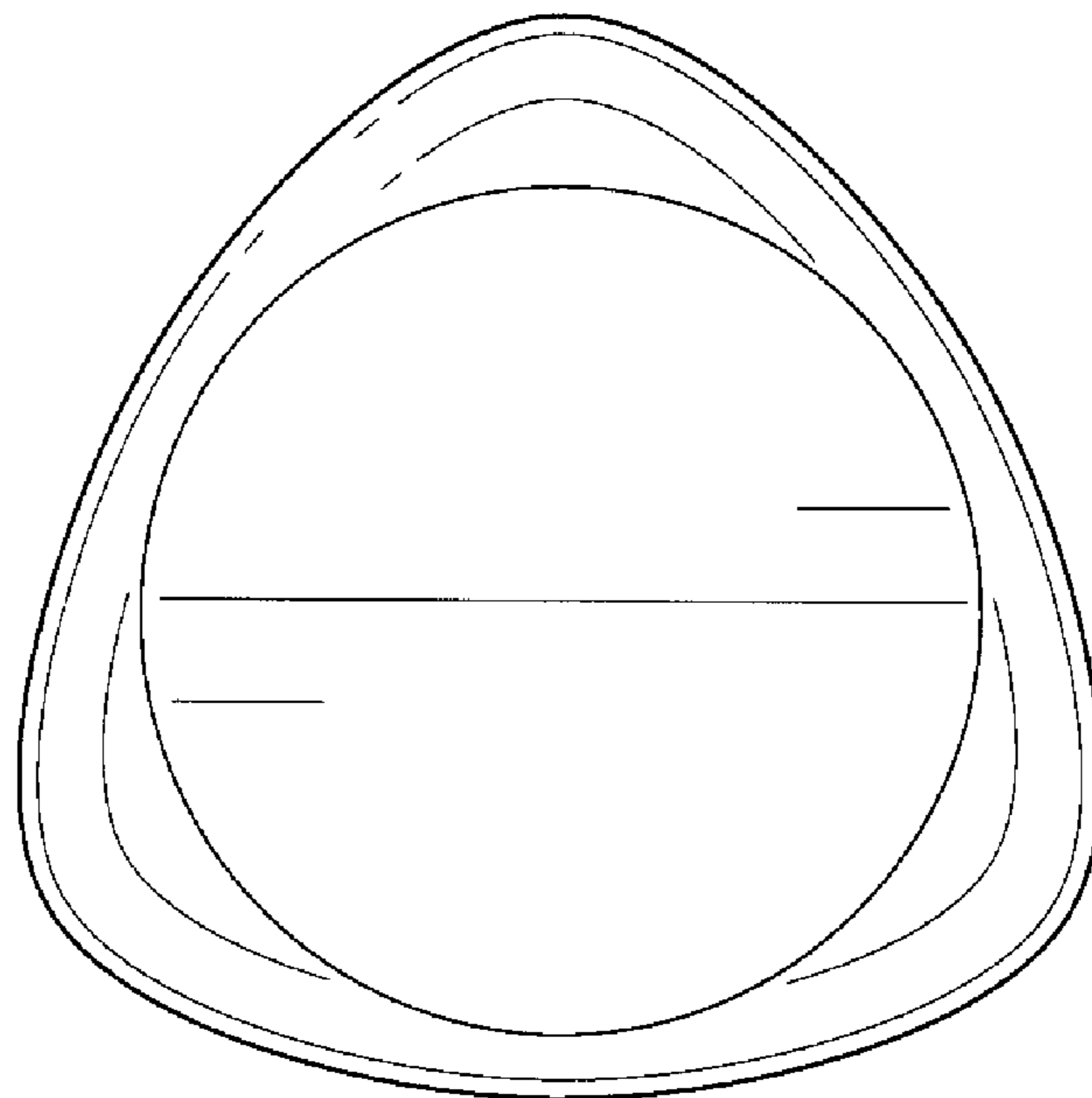

FIG. 14