



US00D582219S

(12) **United States Design Patent**
Prevost et al.

(10) **Patent No.:** **US D582,219 S**
(45) **Date of Patent:** **** Dec. 9, 2008**

(54) **COMBINED STAND AND DRIP PAN FOR COOKING ACCESSORIES**

(76) Inventors: **Robert J. Prevost**, 4425 Capitol Ave., Abilene, TX (US) 79603; **Patricia A. Prevost**, 4425 Capitol Ave., Abilene, TX (US) 79603

(**) Term: **14 Years**

(21) Appl. No.: **29/301,004**

(22) Filed: **Feb. 6, 2008**

(51) **LOC (8) Cl.** **07-07**

(52) **U.S. Cl.** **D7/638; D7/601**

(58) **Field of Classification Search** D7/601, D7/637-641; D8/356, 370; D6/416, 418, D6/462; 211/181.1, 41.2, 41.4, 41.11, 42, 211/70.7; 248/107, 309.1, 175, 176.1, 176.2, 248/37.6

See application file for complete search history.

(56) **References Cited**

U.S. PATENT DOCUMENTS

1,349,084 A	8/1920	Moore	
2,286,012 A *	6/1942	Rochow	248/37.6
D192,531 S	4/1962	Guillaumant	
3,326,387 A	6/1967	Princevalle	
4,515,332 A	5/1985	Scharfy	
4,632,258 A	12/1986	Borner	
4,790,503 A	12/1988	Pohler	
5,038,945 A	8/1991	Melkonian	
5,127,616 A	7/1992	Carney	
D331,671 S *	12/1992	Adams	D6/416
5,246,195 A	9/1993	Huff	

5,297,766 A	3/1994	Hoffman	
5,396,993 A *	3/1995	Spitler	211/41.2
5,683,010 A	11/1997	Boyajian, Jr.	
D394,370 S *	5/1998	Hollinger	D7/637
6,505,746 B1 *	1/2003	Johnson	211/70.7
6,585,200 B2	7/2003	Borodulin et al.	
6,672,550 B1	1/2004	Borodulin et al.	
D511,944 S	11/2005	Kaposi	
D517,870 S *	3/2006	Perkins	D7/637
7,025,312 B1	4/2006	Dare	
D527,228 S	8/2006	Joseph	
D546,129 S	7/2007	Sergianni	

* cited by examiner

Primary Examiner—Terry A Wallace

(74) *Attorney, Agent, or Firm*—Robert C. Montgomery; Eugene A. Vittone, II

(57) **CLAIM**

The ornamental design for a combined stand and drip pan for cooking accessories, as shown and described.

DESCRIPTION

FIG. 1 is a perspective view of a combined stand and drip pan for cooking accessories, as shown and described with a cooking accessory supported therefrom;

FIG. 2 is a front view thereof;

FIG. 3 is a rear view thereof;

FIG. 4 is a left side view thereof;

FIG. 5 is a right side view thereof;

FIG. 6 is a top view thereof; and,

FIG. 7 is a bottom view thereof.

1 Claim, 7 Drawing Sheets

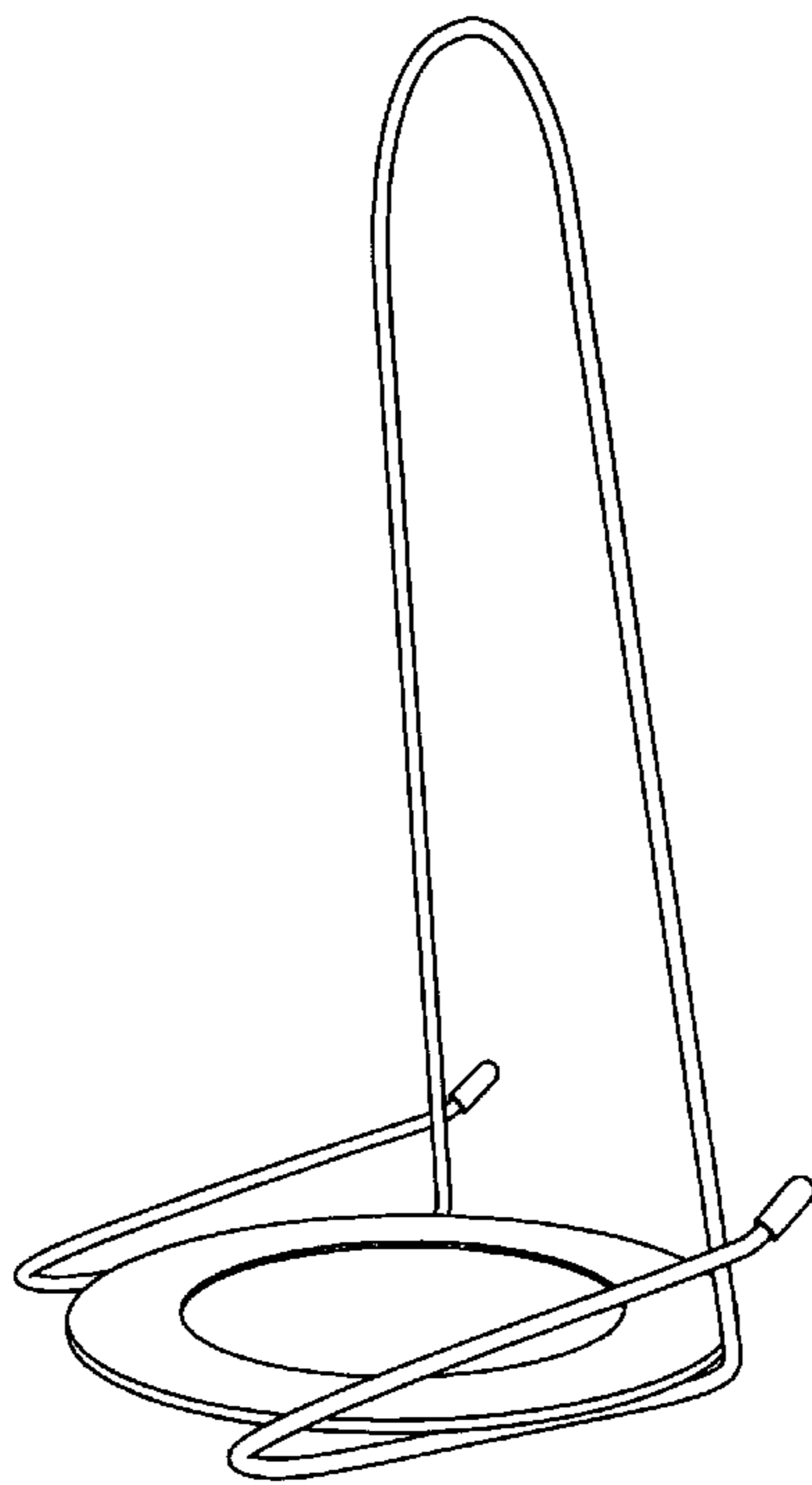

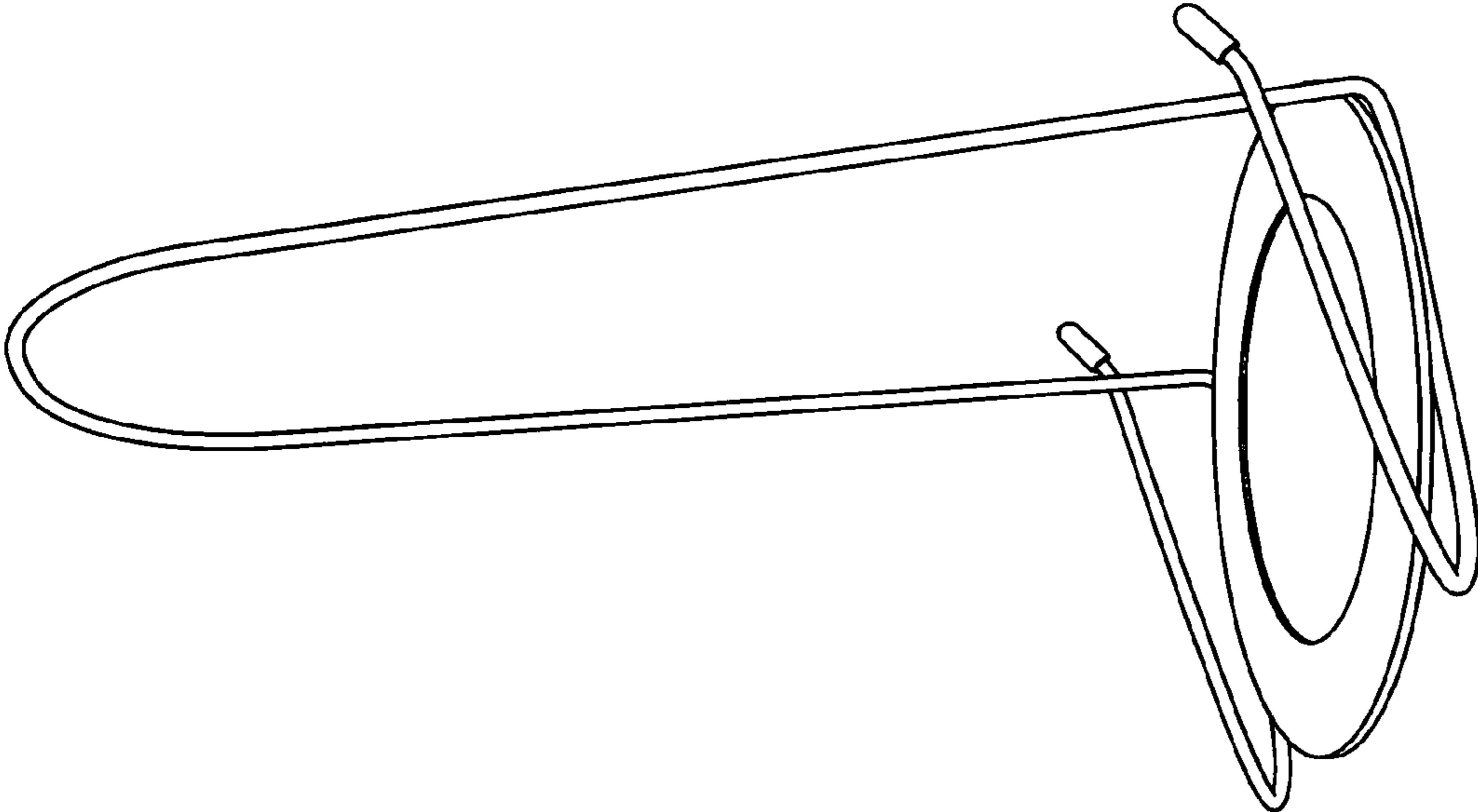

Fig 1

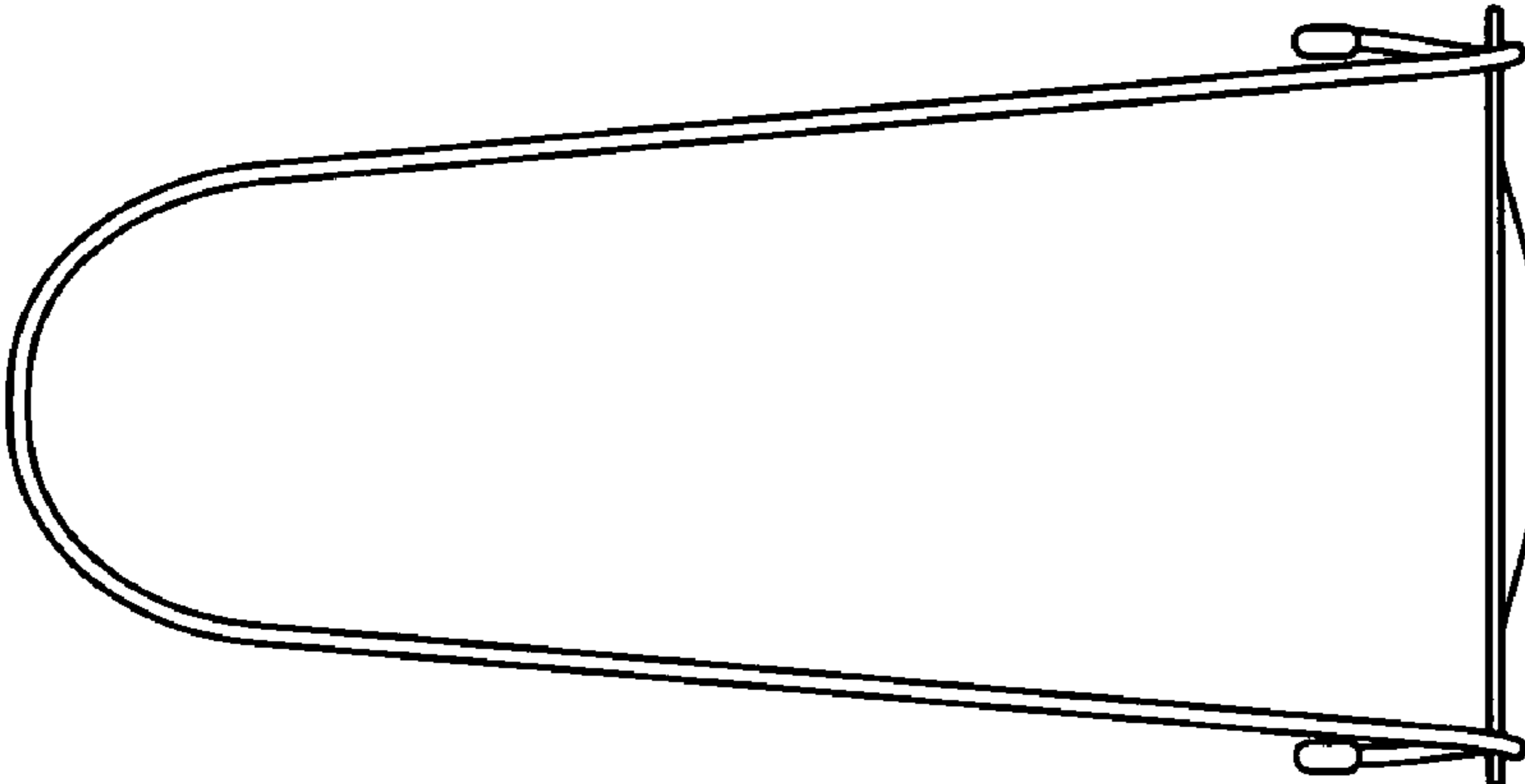

Fig 2

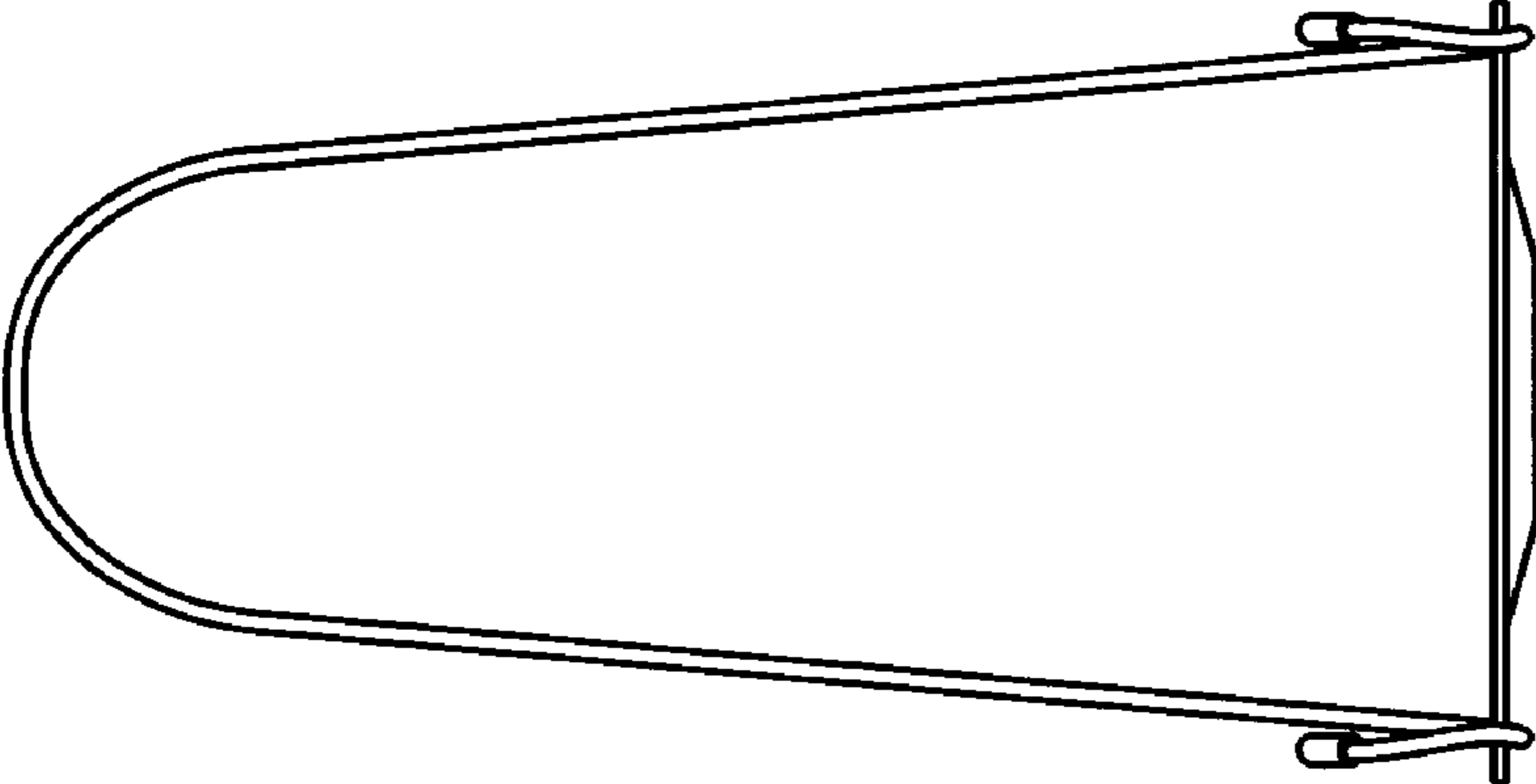

Fig 3

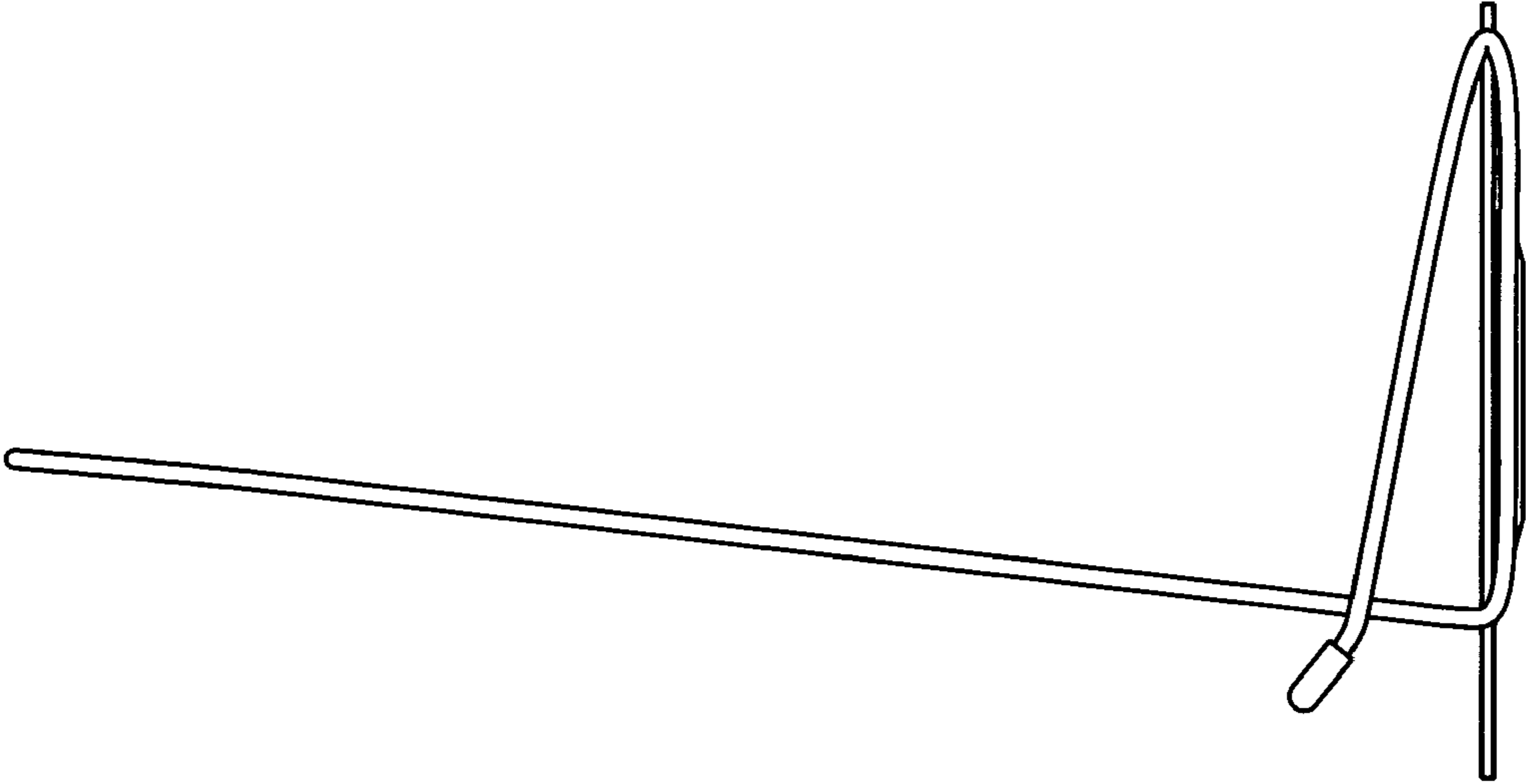

Fig 4

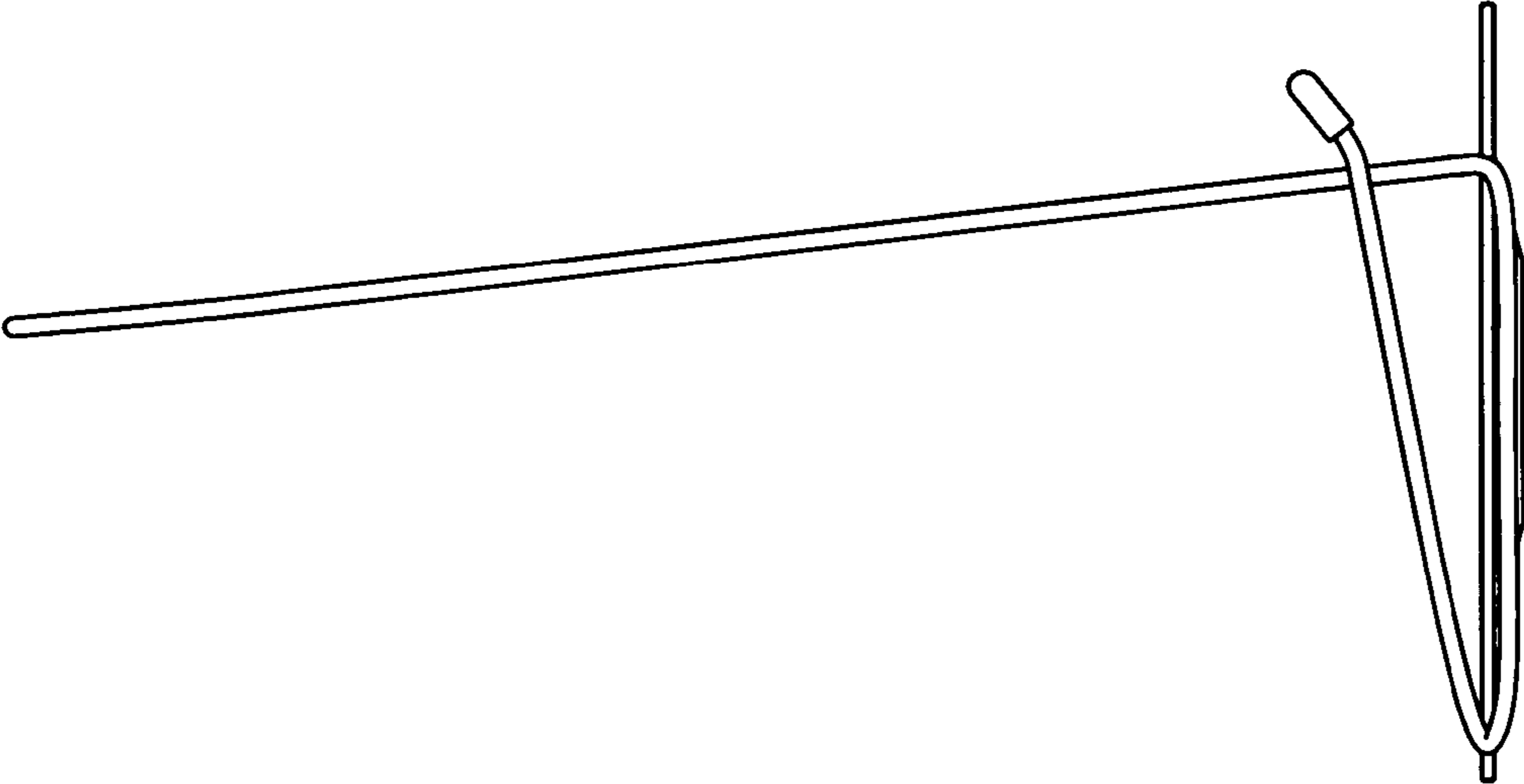

Fig 5

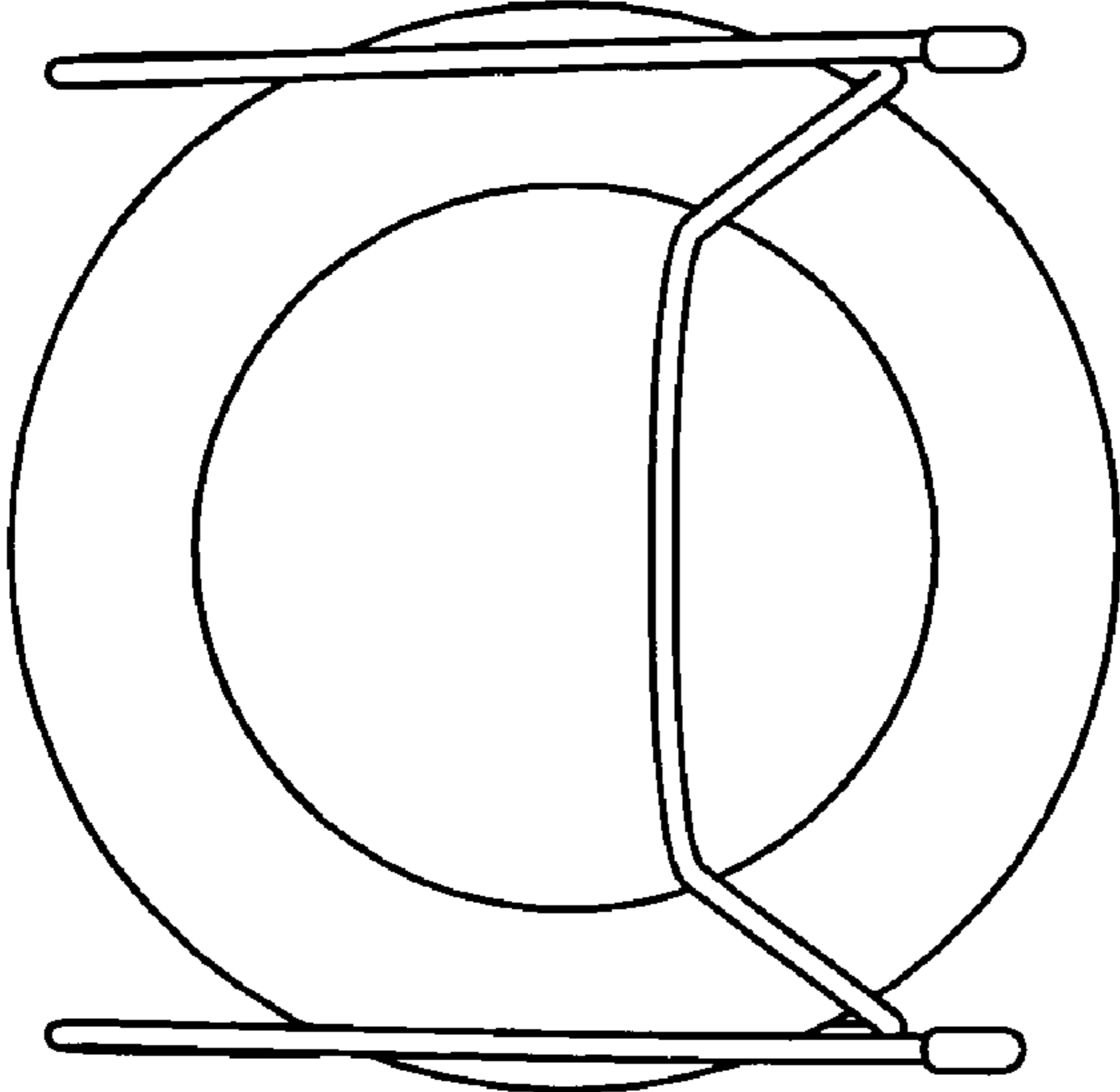

Fig 6

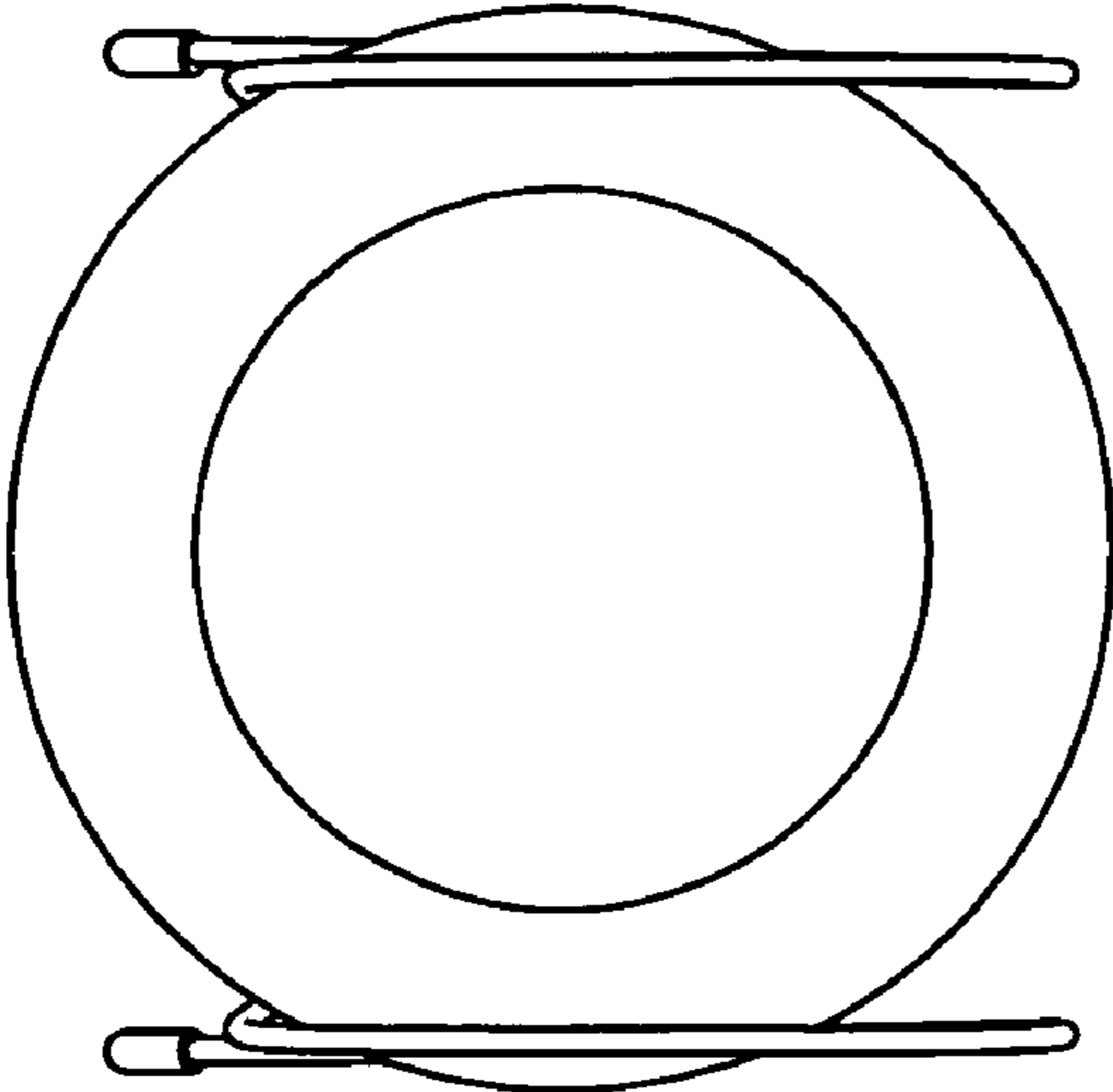

Fig 7