



US00D582120S

(12) **United States Design Patent**
Snell

(10) **Patent No.:** **US D582,120 S**
(45) **Date of Patent:** **** Dec. 2, 2008**

(54) **DUAL SCRUB HOLDER**

(75) Inventor: **Russell Benton Snell**, Bentleyville, OH (US)

(73) Assignee: **InterDesign, Inc.**, Solon, OH (US)

(**) Term: **14 Years**

(21) Appl. No.: **29/265,650**

(22) Filed: **Sep. 6, 2006**

(51) **LOC (8) Cl.** **07-05**

(52) **U.S. Cl.** **D32/55**

(58) **Field of Classification Search** D32/55-57;
D6/566-567; D7/667, 637-641; D19/65,
D19/81-83, 85; 220/485, 572, 571.1; 248/37.3;
134/135; 4/637, 656

See application file for complete search history.

(56) **References Cited**

U.S. PATENT DOCUMENTS

1,623,703	A *	4/1927	Ruff	220/23.87
2,666,549	A *	1/1954	Horne, Jr.	220/487
3,661,351	A *	5/1972	Olsen	248/210
4,730,802	A *	3/1988	Chatham et al.	248/238
D334,265	S *	3/1993	Giugiaro	D32/55
D362,943	S *	10/1995	Licari	D32/55
5,547,087	A *	8/1996	Licari	211/41.2
D402,777	S *	12/1998	Miller	D32/55
6,062,397	A *	5/2000	Licari	211/41.3
D447,918	S *	9/2001	Wolfenden	D7/637
D523,297	S *	6/2006	Yang et al.	D7/637

D523,298 S * 6/2006 Yang et al. D7/637

OTHER PUBLICATIONS

2004 InterDesign, Inc. product brochure, p. 4, 6 w/front & back cover.

* cited by examiner

Primary Examiner—Pamela J Burgess

(74) *Attorney, Agent, or Firm*—D. Peter Hochberg; Sean F. Mellino; Daniel J. Smola

(57) **CLAIM**

The ornamental design for a dual scrub holder, as shown and described.

DESCRIPTION

FIG. 1 is a perspective view of the dual scrub holder according to the invention;

FIG. 2 is a top view of the dual scrub holder as shown in FIG. 1;

FIG. 3 is a front view of the dual scrub holder as shown in FIG. 1;

FIG. 4 is a side view of the dual scrub holder as shown in FIG. 1;

FIG. 5 is a rear view of the dual scrub holder as shown in FIG. 1;

FIG. 6 is a side view of the dual scrub holder as shown in FIG. 1, shown from the opposite side as that shown in FIG. 4; and,

FIG. 7 is a bottom view of the dual scrub holder as shown in FIG. 1.

1 Claim, 3 Drawing Sheets

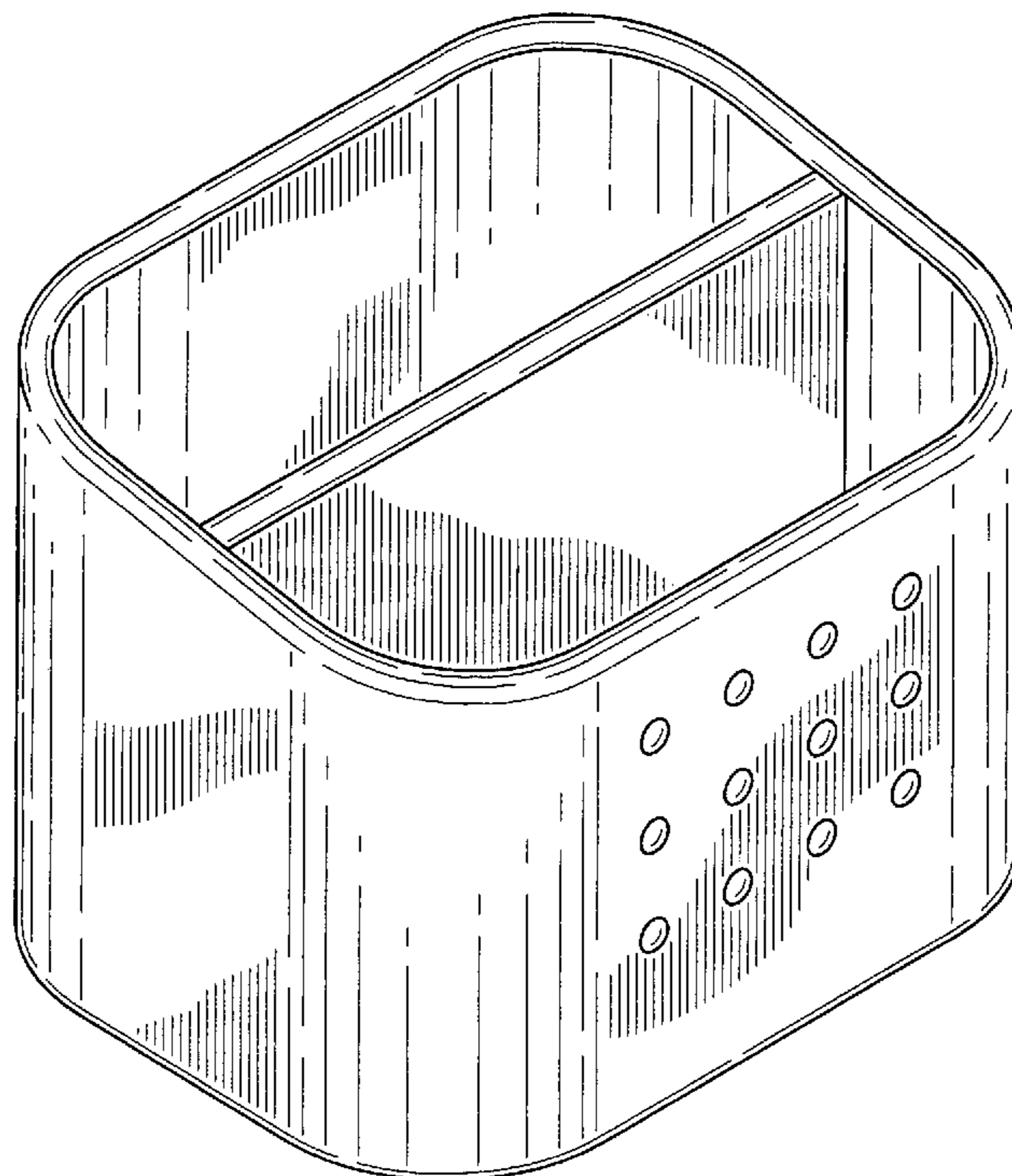

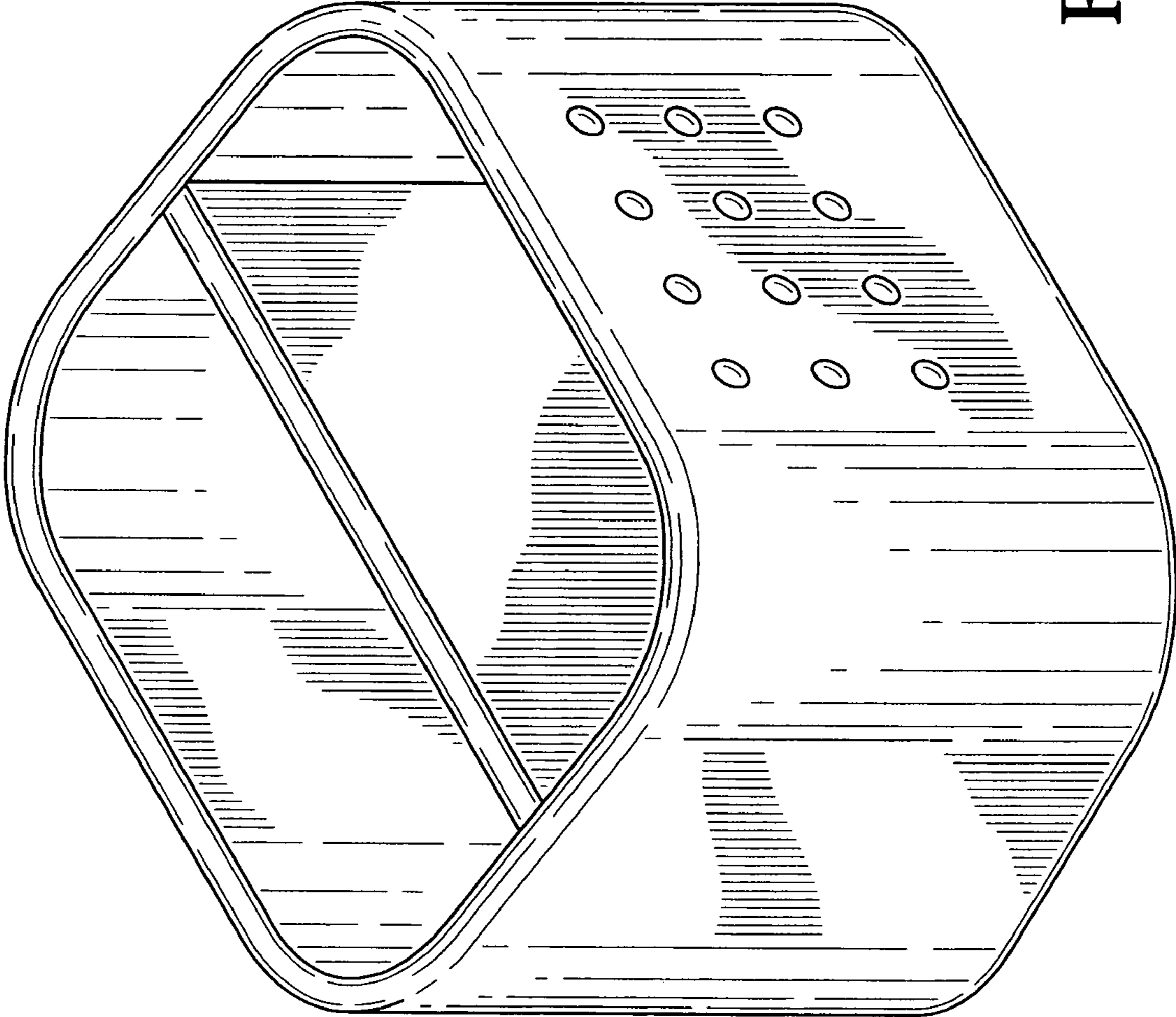

FIG-1

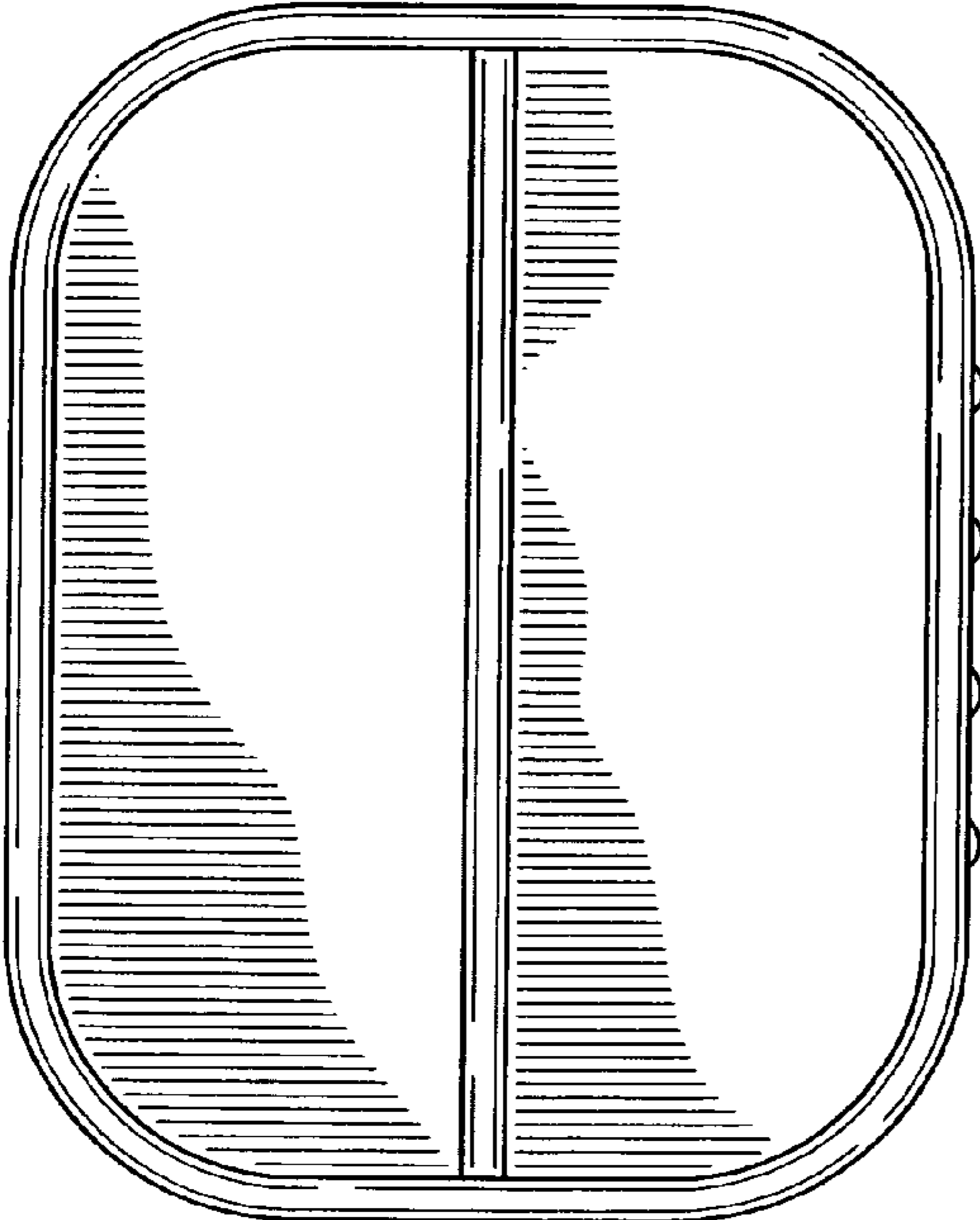

FIG-2

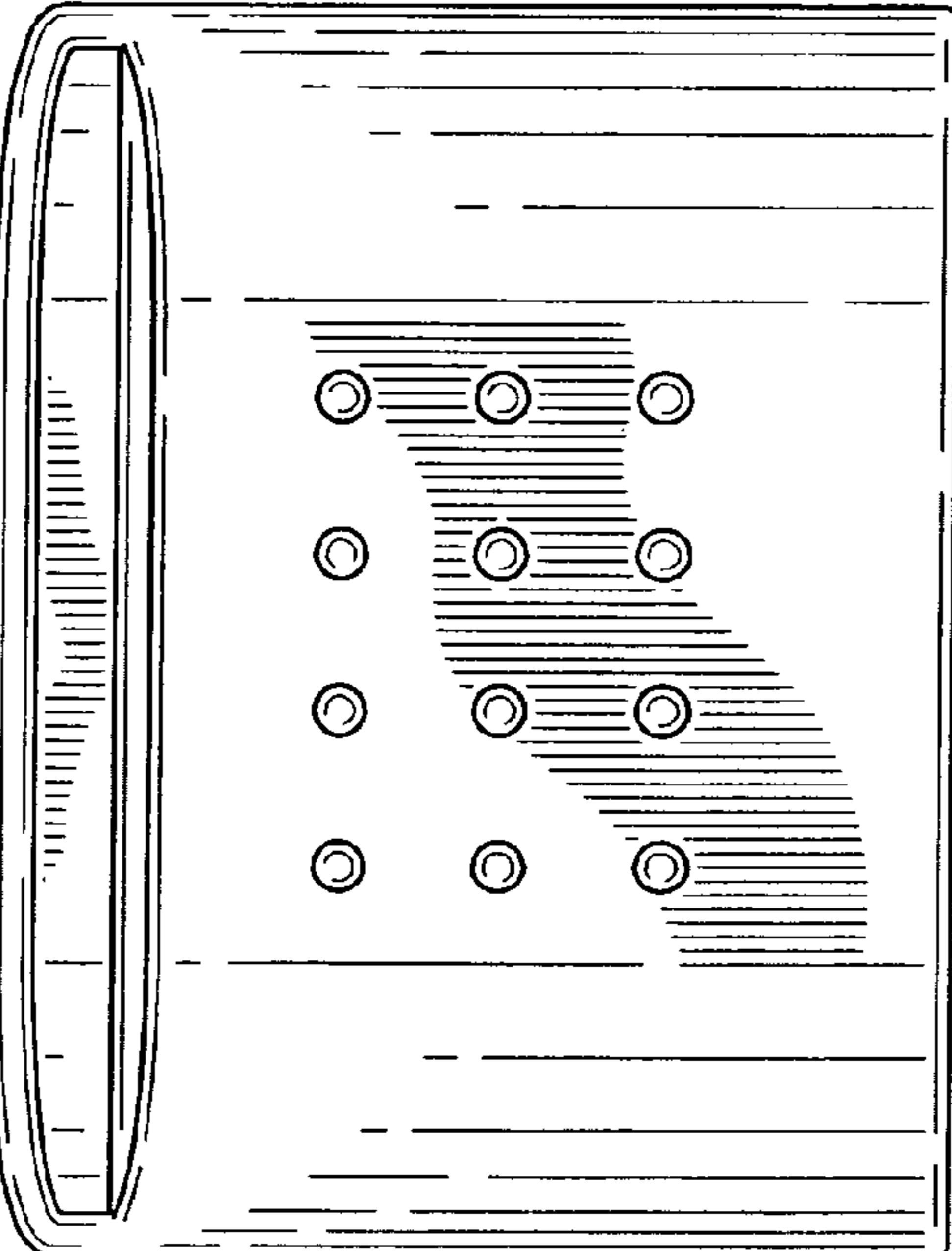

FIG-3

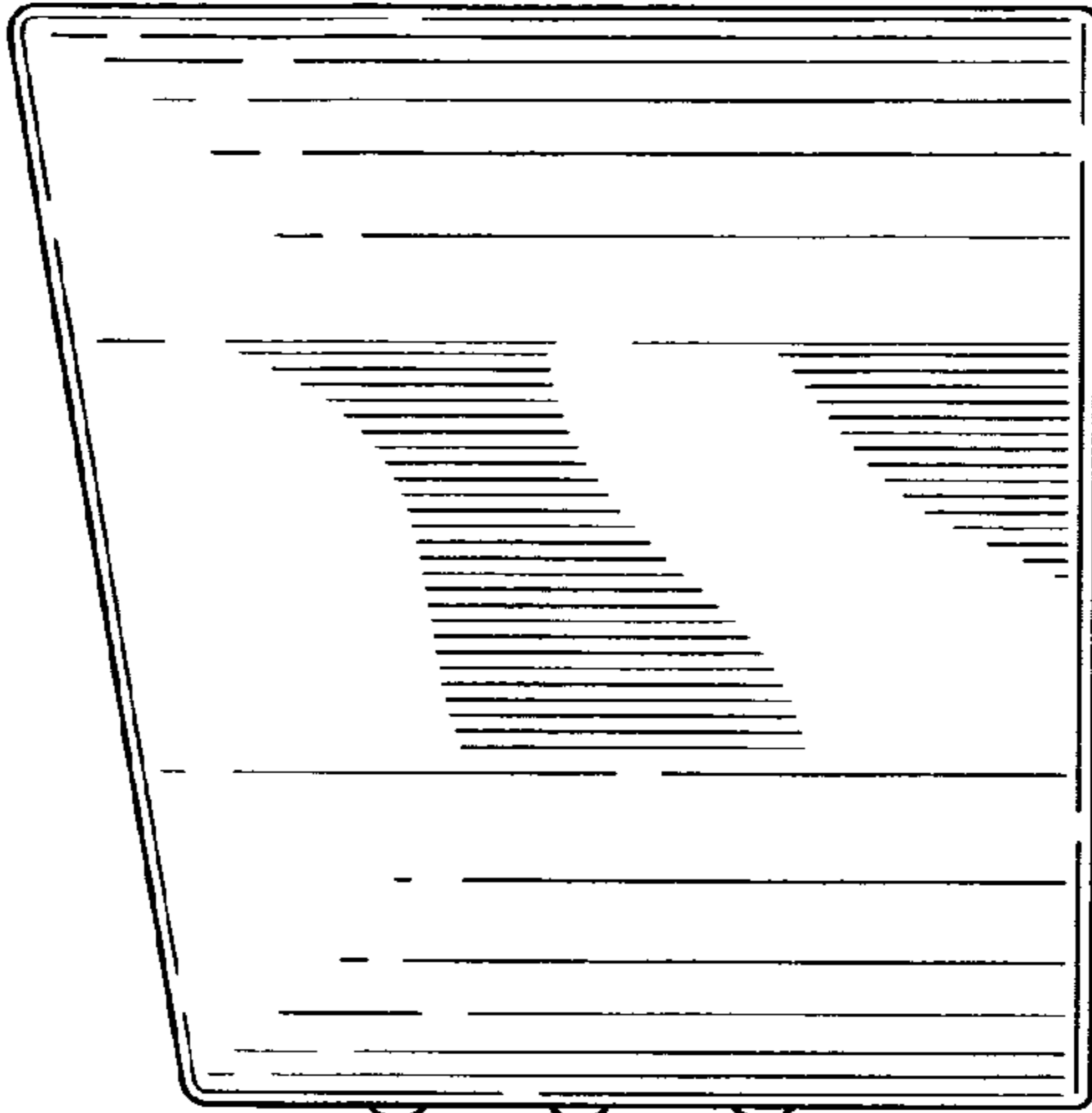

FIG-4

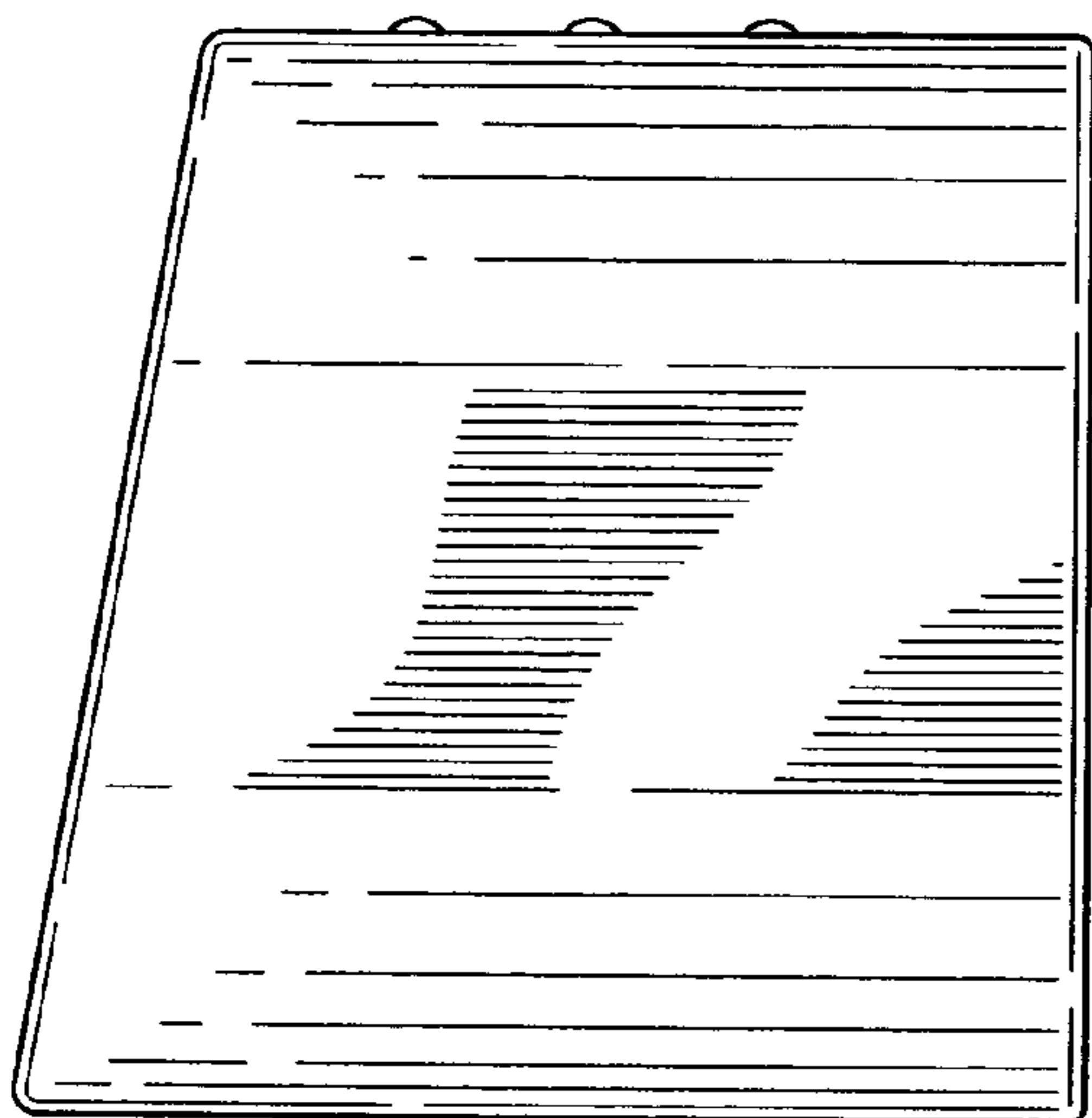

FIG-6

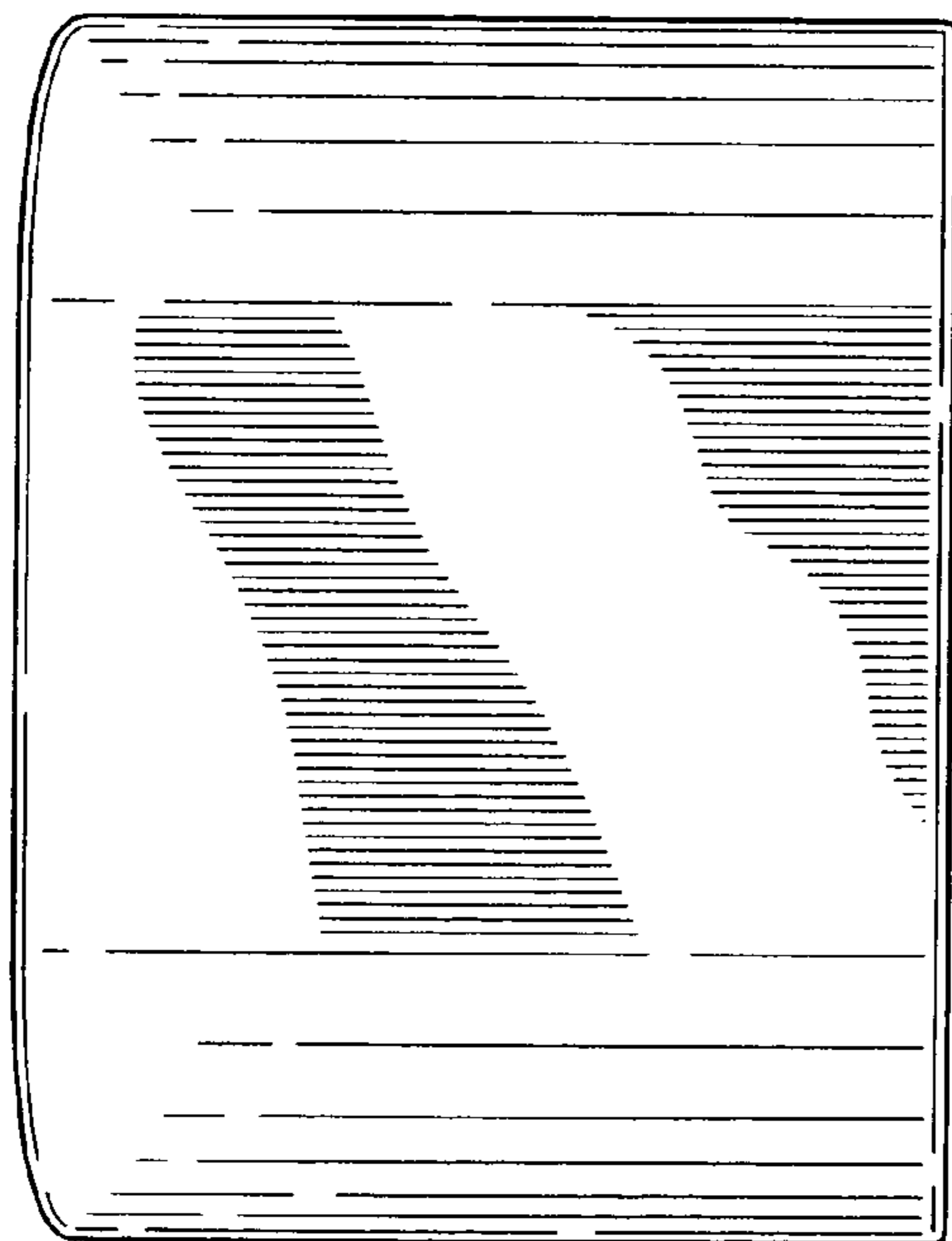

FIG-5

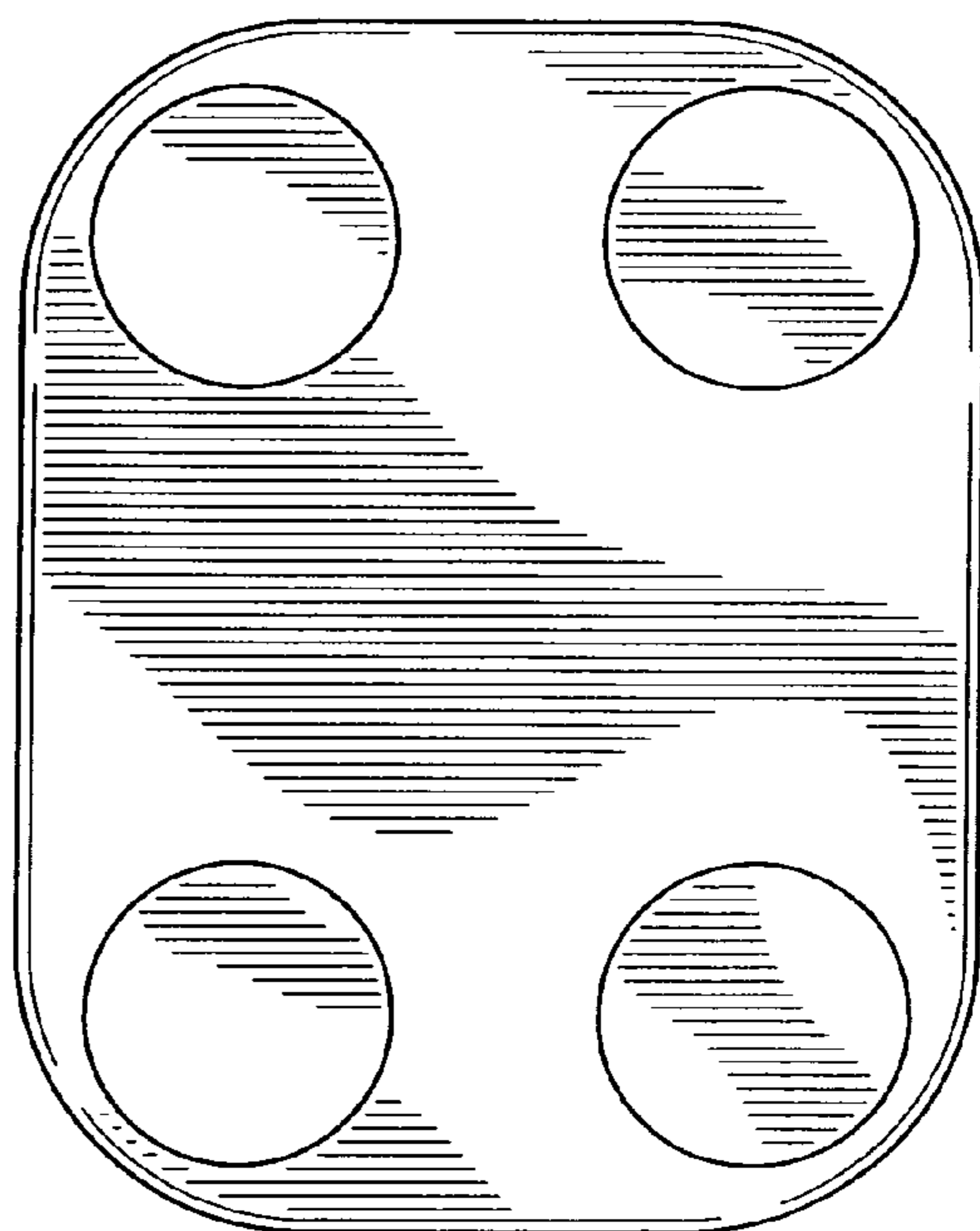

FIG-7