



US00D581997S

(12) **United States Design Patent**  
**Rogers et al.**

(10) **Patent No.:** **US D581,997 S**

(45) **Date of Patent:** **\*\* Dec. 2, 2008**

(54) **DECOY**

6,698,132 B1 3/2004 Brint  
D488,849 S \* 4/2004 Olson et al. .... D22/125  
6,907,688 B2 6/2005 Brint

(75) Inventors: **Jay Rogers**, Hudson, WI (US); **Dennis Stillwell**, Hudson, WI (US)

\* cited by examiner

(73) Assignee: **Expedite International, Inc.**, Hudson, WI (US)

*Primary Examiner*—Catherine R Oliver  
(74) *Attorney, Agent, or Firm*—Skinner and Associates

(\*\*) Term: **14 Years**

(57) **CLAIM**

(21) Appl. No.: **29/301,090**

The ornamental design for a decoy, as shown and described.

(22) Filed: **Feb. 8, 2008**

**DESCRIPTION**

(51) **LOC (8) Cl.** ..... **22-05**

FIG. 1 is a perspective view of the decoy showing an embodiment of the design of this invention.

(52) **U.S. Cl.** ..... **D22/125**

FIG. 2 is another perspective view of the decoy.

(58) **Field of Classification Search** ..... D22/125-133;  
43/1-3, 26.1, 26.2, 17.5; D21/510, 608;  
446/217

FIG. 3 is a top view of the decoy.

FIG. 4 is a bottom view of the decoy.

See application file for complete search history.

FIG. 5 is a right side view of the decoy.

FIG. 6 is a left side view of the decoy.

(56) **References Cited**

**U.S. PATENT DOCUMENTS**

2,884,729 A \* 5/1959 Walton ..... 43/2  
D475,759 S \* 6/2003 Salato ..... D22/125  
D477,651 S \* 7/2003 Paw ..... D22/125

FIG. 7 is a front end view of the decoy; and,

FIG. 8 is a rear end view of the decoy.

**1 Claim, 8 Drawing Sheets**

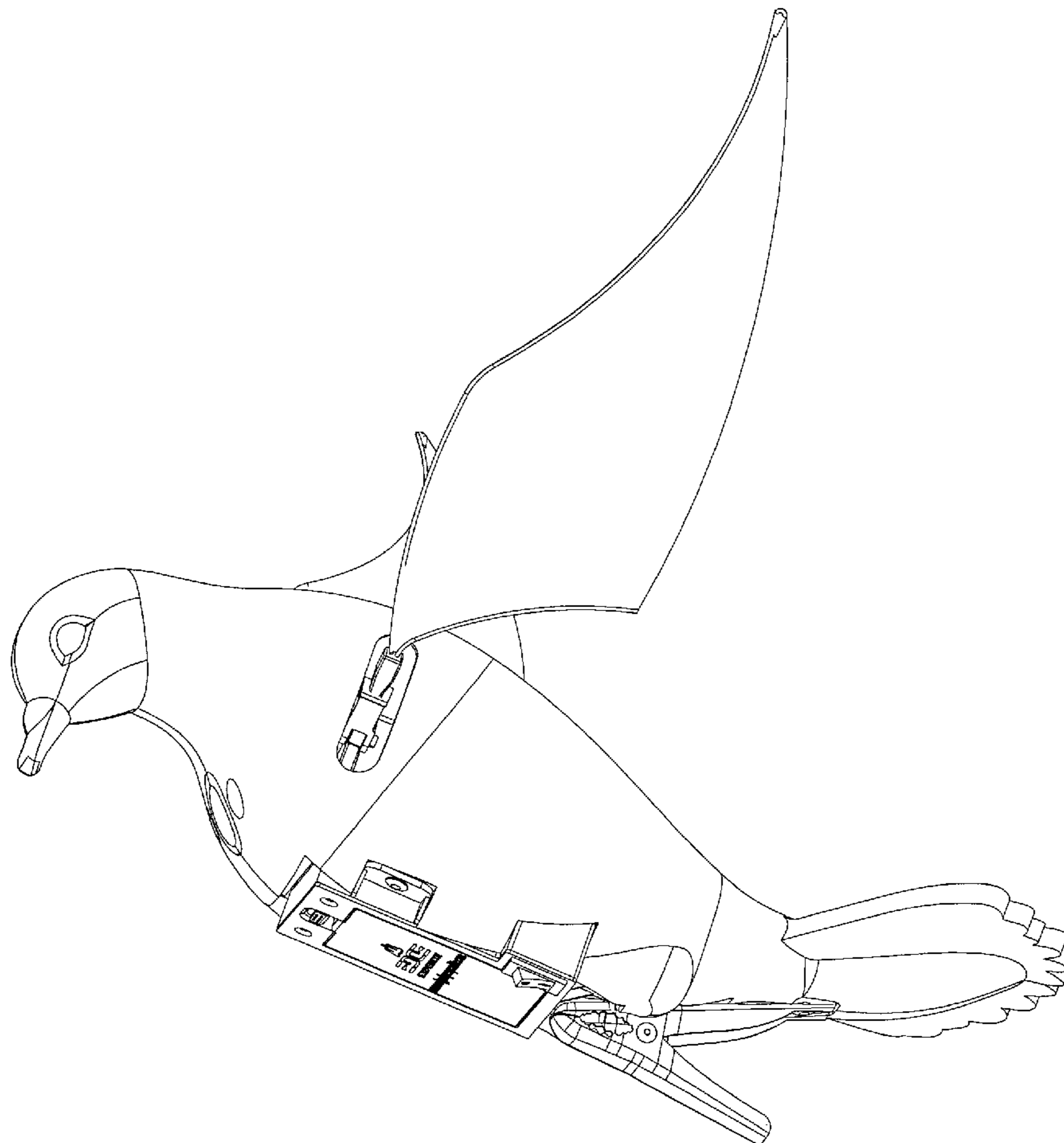

FIG. 1

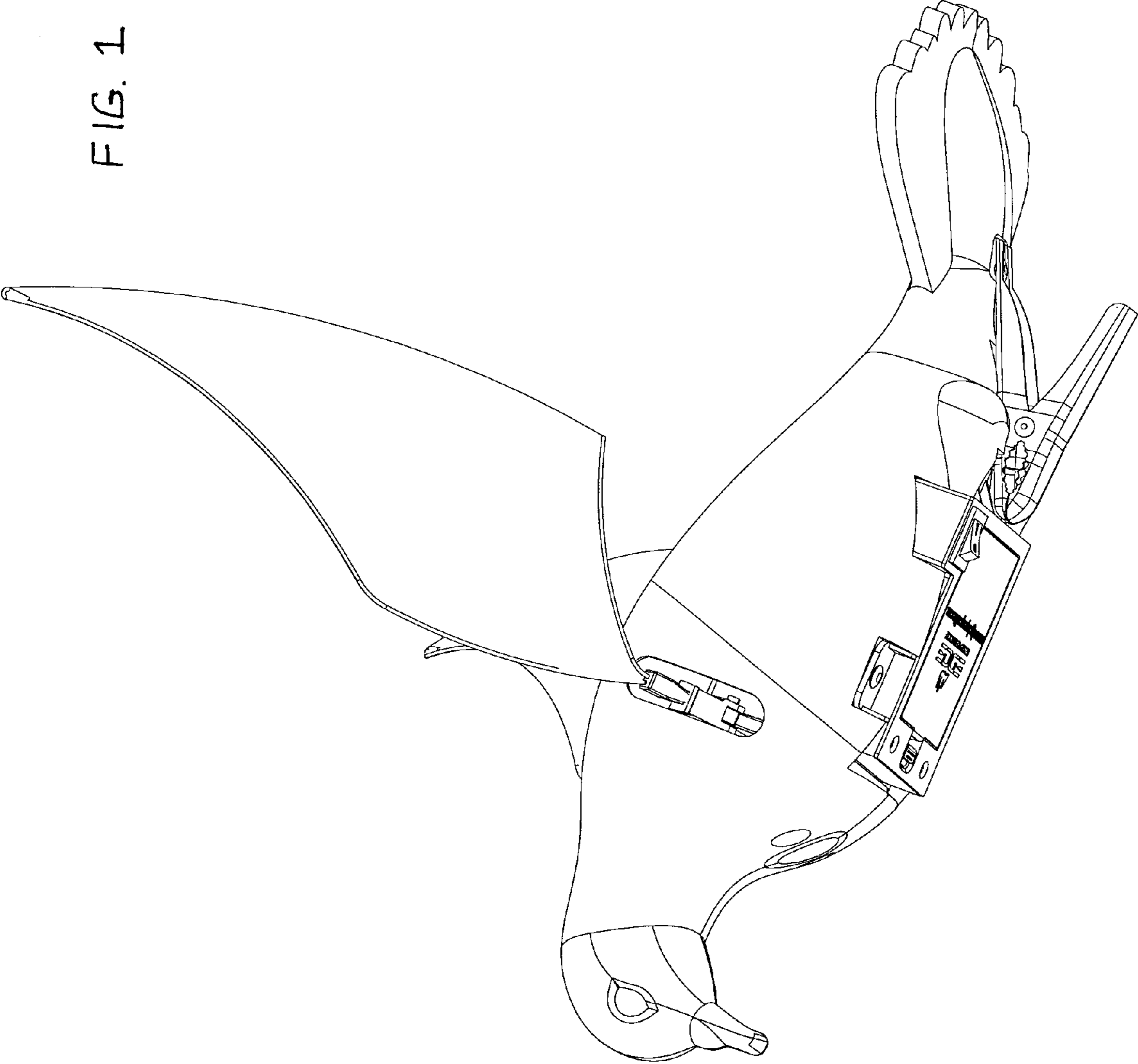

FIG. 2

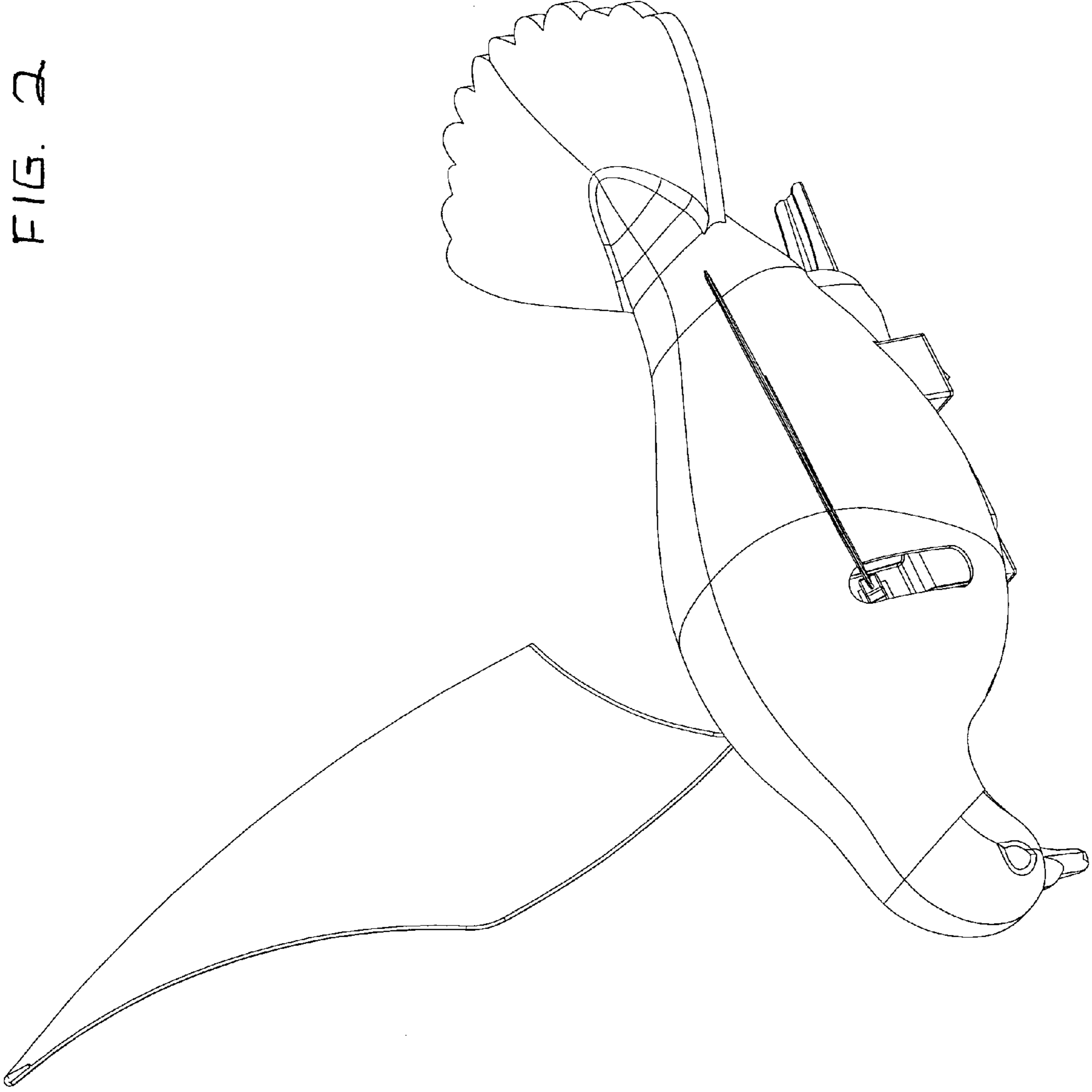

FIG. 3

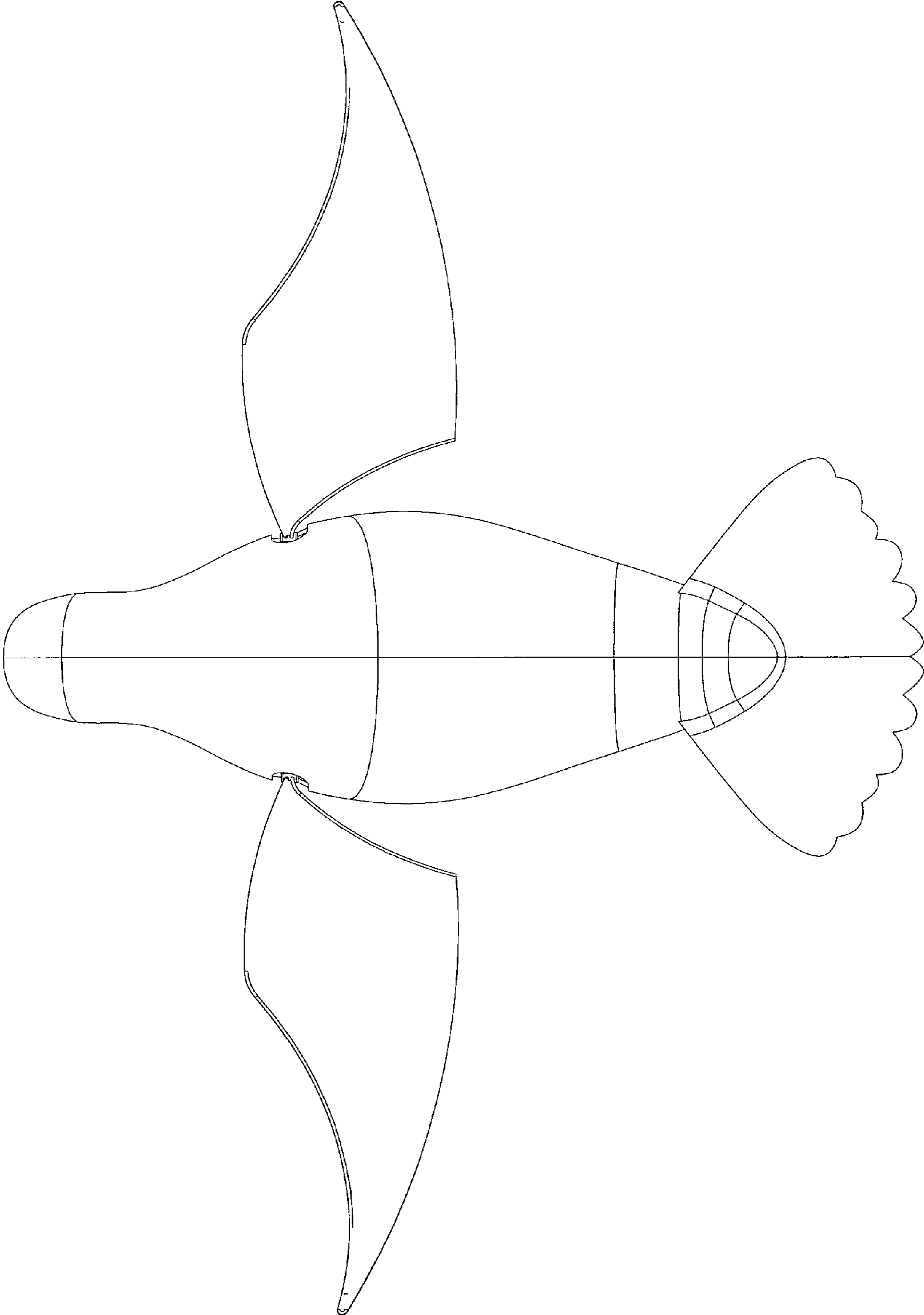

FIG. 4

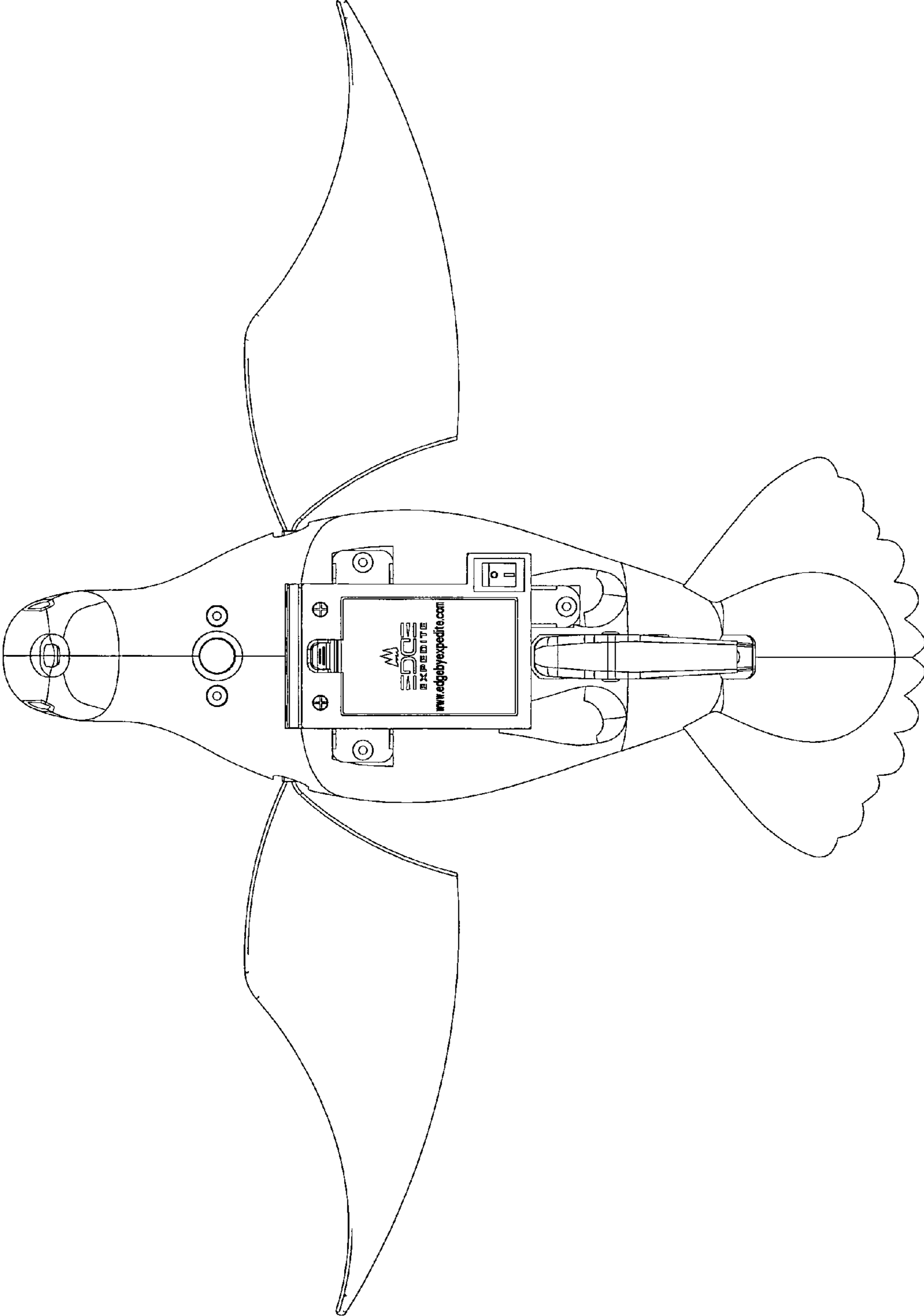

FIG. 5

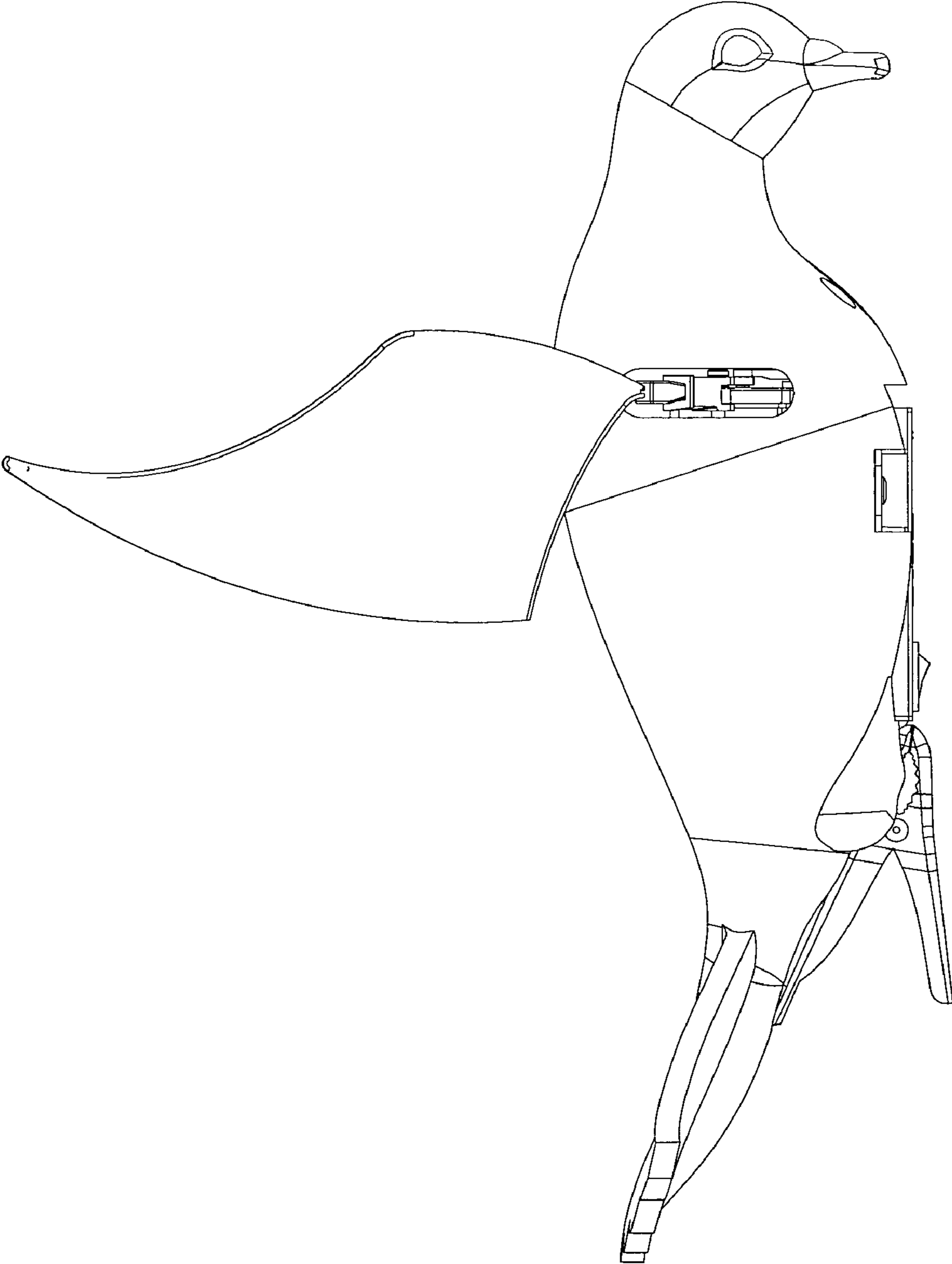

FIG 6

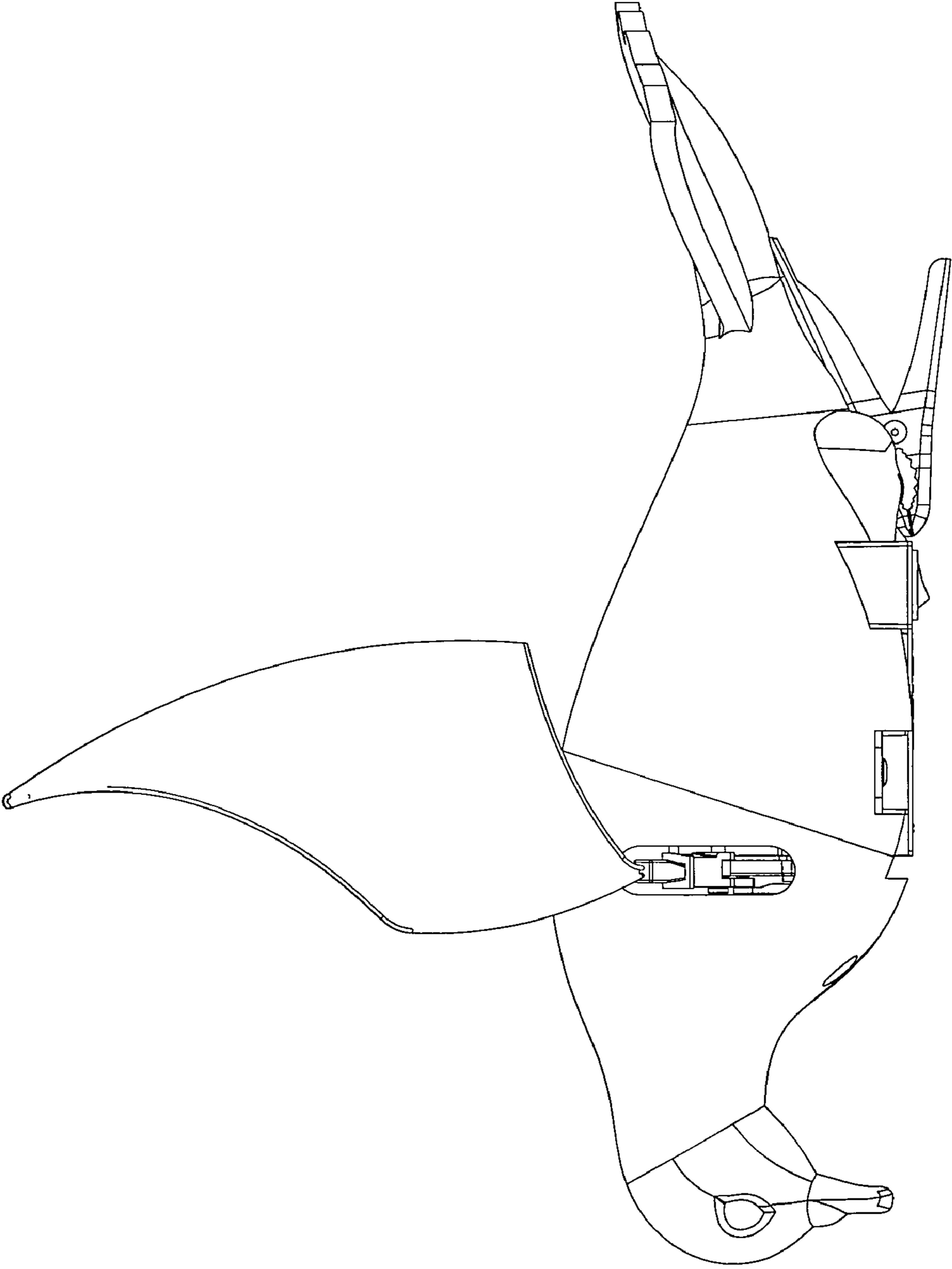

FIG 7

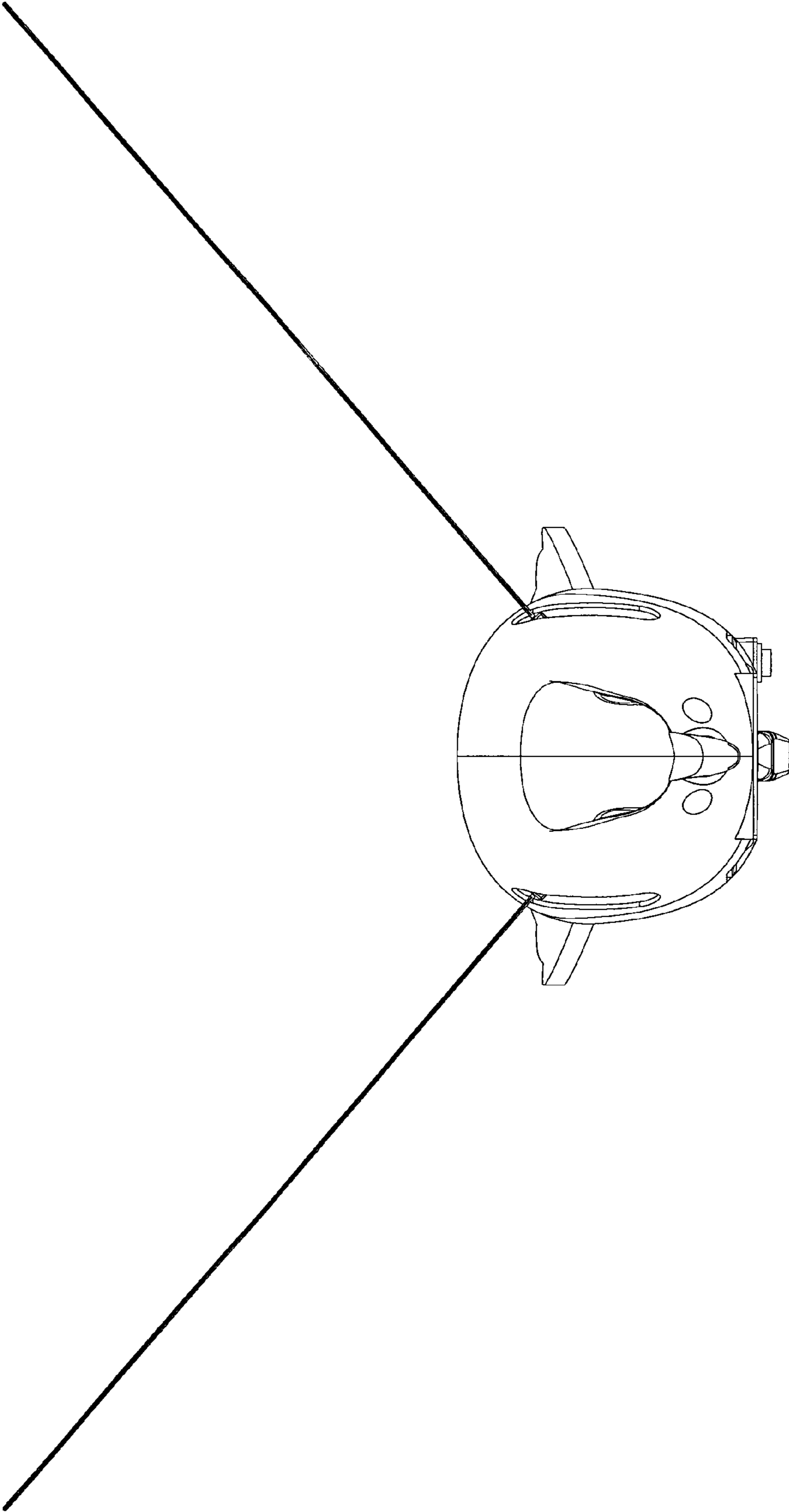



FIG. 8

