



US00D581989S

(12) **United States Design Patent**
Nakamura

(10) **Patent No.:** **US D581,989 S**
(45) **Date of Patent:** **** Dec. 2, 2008**

(54) **ELECTRONIC TOY**

D484,917 S * 1/2004 Hunt et al. D21/329
D494,145 S * 8/2004 Klimas D13/168

(75) Inventor: **Michael L. Nakamura**, Crystal Lake, IL
(US)

OTHER PUBLICATIONS

Co-Pending U.S. Appl. No.: 12/120,751, filed May 15, 2008.*
Co-Pending U.S. Appl. No.: 12/120,780, filed May 15, 2008.*

(73) Assignee: **Senario, LLC**, Woodstock, IL (US)

* cited by examiner

(**) Term: **14 Years**

Primary Examiner—Prabhakar Deshmukh

(21) Appl. No.: **29/318,198**

(74) *Attorney, Agent, or Firm*—Pauley Petersen & Erickson

(22) Filed: **May 15, 2008**

(57) **CLAIM**

(51) **LOC (8) Cl.** **21-01**

The ornamental design for an electronic toy, as shown.

(52) **U.S. Cl.** **D21/329**

(58) **Field of Classification Search** D21/324–330,
D21/333; 273/148 B; 463/1, 29–25, 46,
463/47; 345/156, 906; D14/496, 125
See application file for complete search history.

DESCRIPTION

(56) **References Cited**

FIG. 1 is a perspective view of an electronic toy showing my new design;

U.S. PATENT DOCUMENTS

FIG. 2 is a front view of the electronic toy, as shown in FIG. 1;

- 5,184,830 A * 2/1993 Okada et al. 463/29
- 5,213,327 A * 5/1993 Kitae 463/38
- 5,476,261 A * 12/1995 Hultstrand 273/148 B
- 5,661,632 A * 8/1997 Register 361/683
- D394,461 S * 5/1998 Liu D21/329
- D406,613 S * 3/1999 Nakanishi D21/329
- 5,926,438 A * 7/1999 Saito 367/111
- D422,029 S * 3/2000 Goto D21/329
- D424,626 S * 5/2000 Goto D21/329
- D429,287 S * 8/2000 Nara et al. D21/329
- D460,121 S * 7/2002 Furusato D21/329

FIG. 3 is a rear view of the electronic toy, as shown in FIG. 1;

FIG. 4 is a side view of the electronic toy, as shown in FIG. 1;

FIG. 5 is a side view, opposite the side view shown in FIG. 4, of the electronic toy, as shown in FIG. 1;

FIG. 6 is a top view of the electronic toy, as shown in FIG. 1; and,

FIG. 7 is a bottom view of the electronic toy, as shown in FIG. 1.

1 Claim, 5 Drawing Sheets

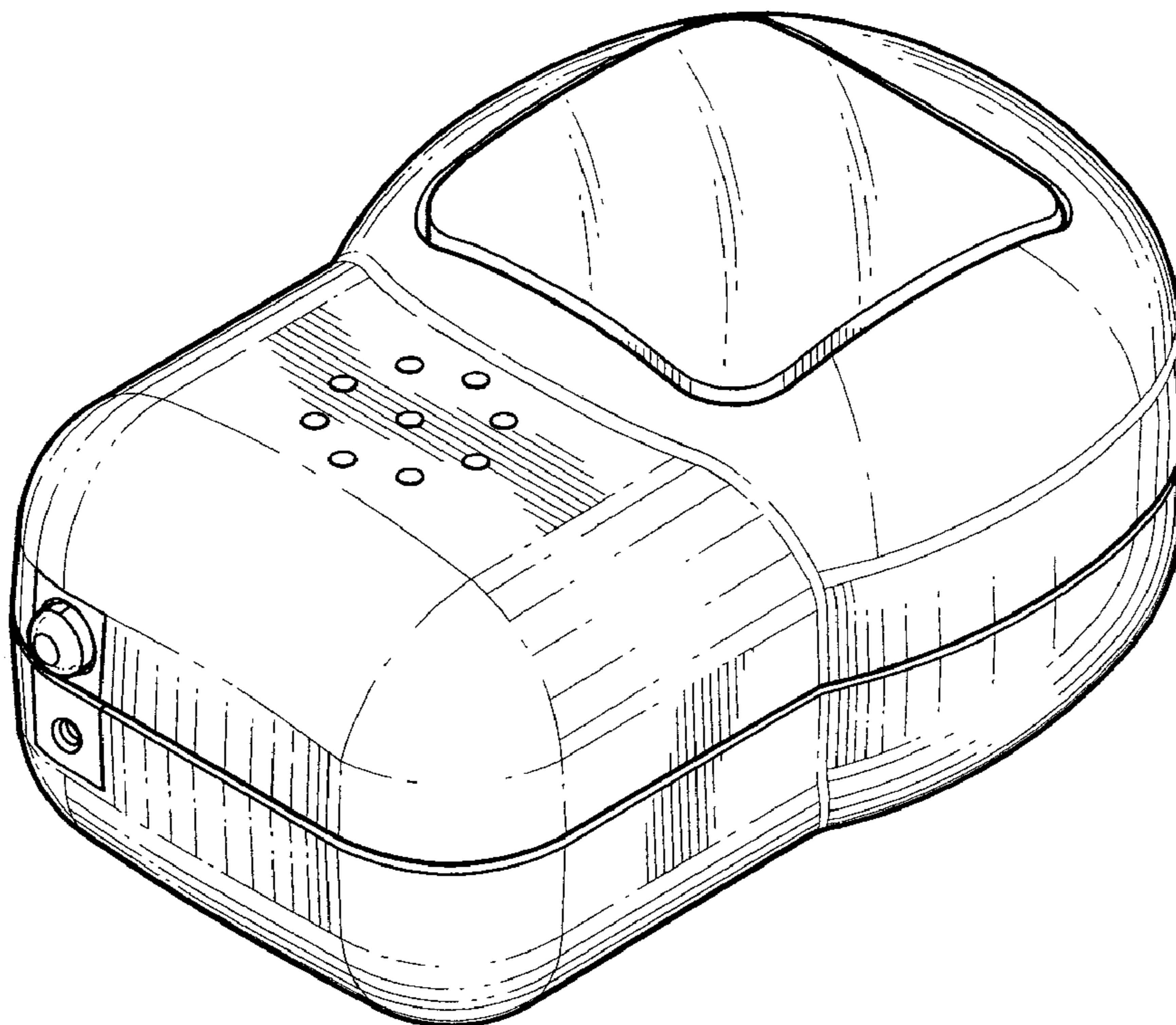

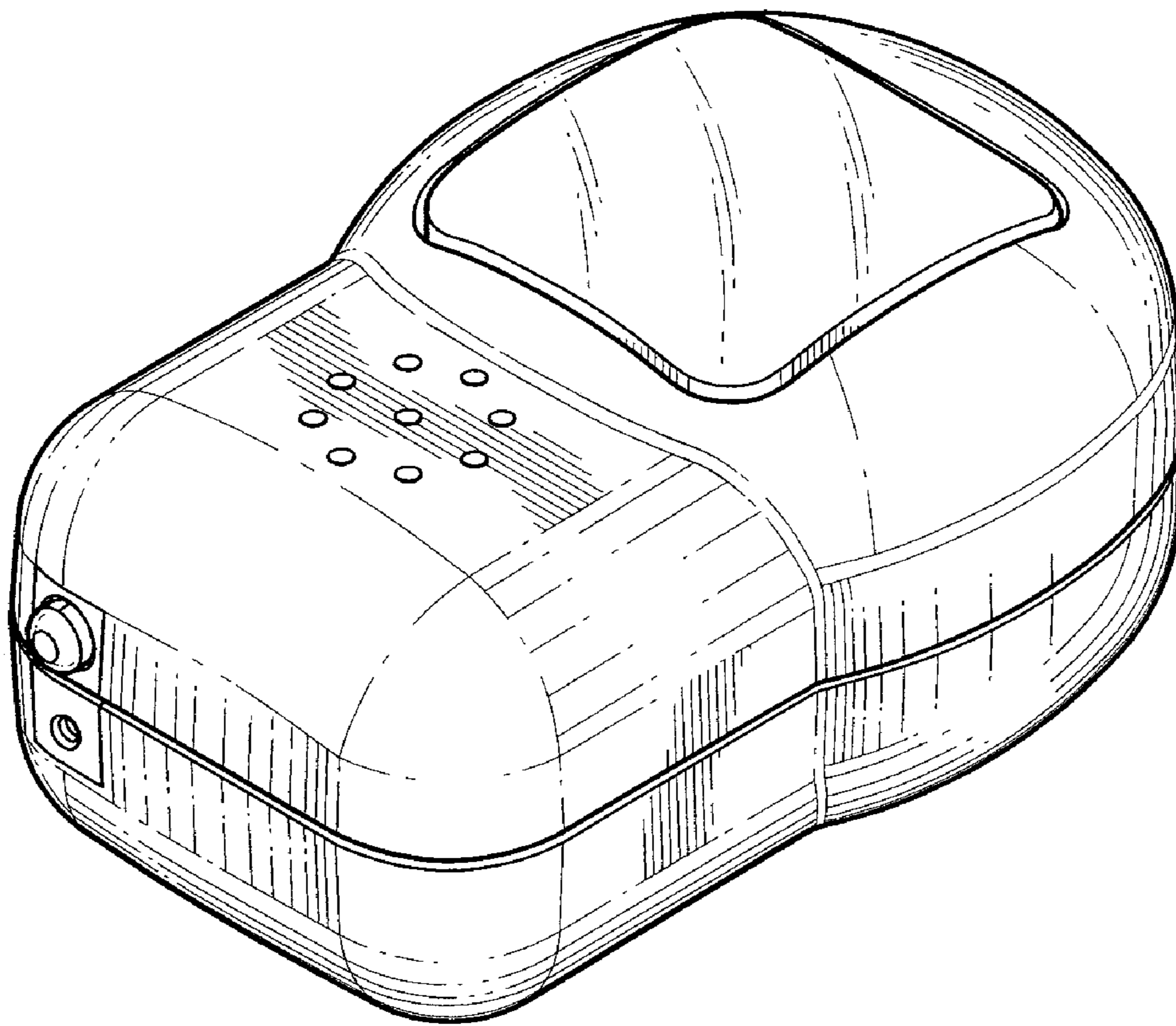

FIG. 1

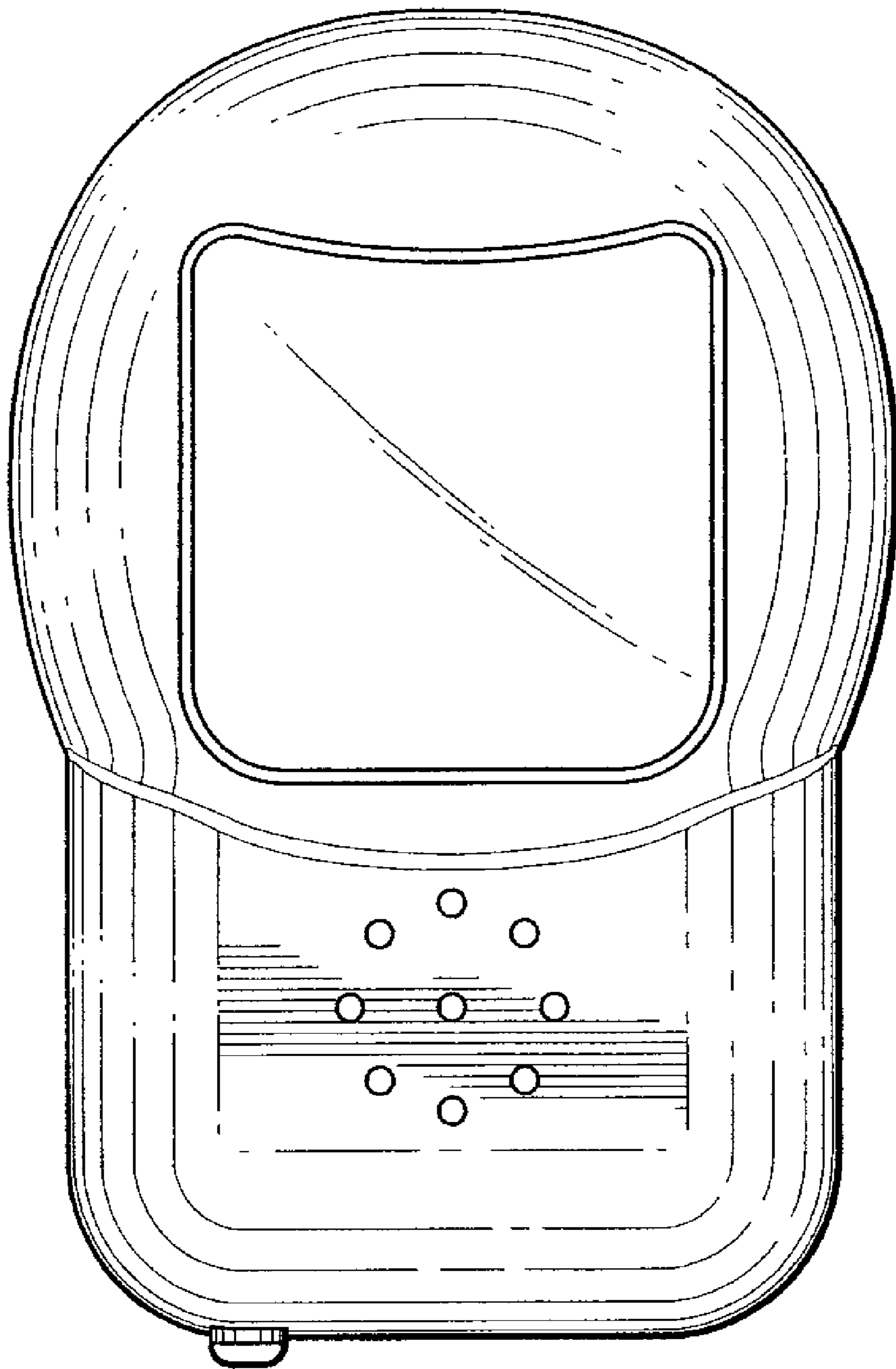

FIG. 2

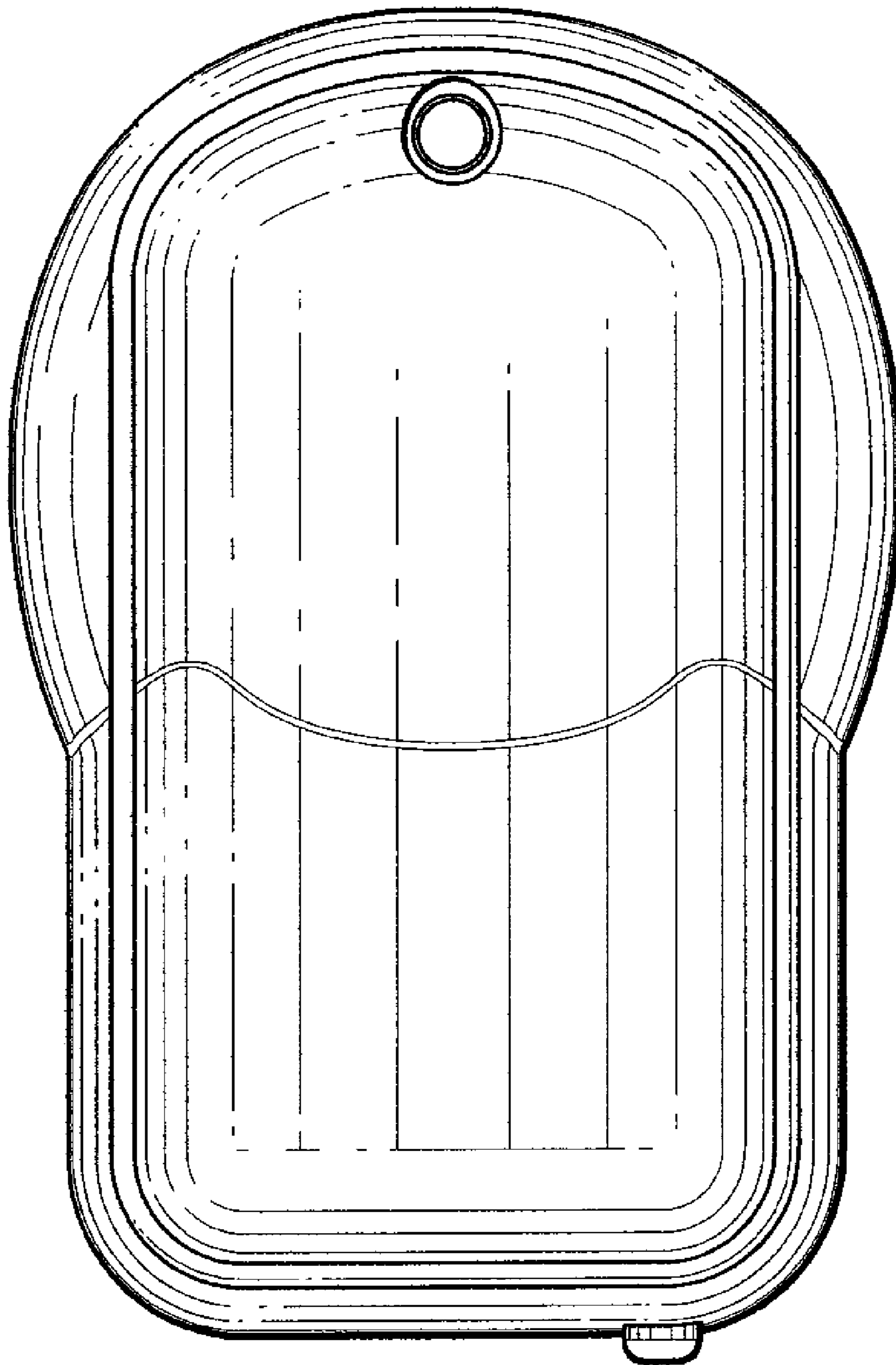

FIG. 3

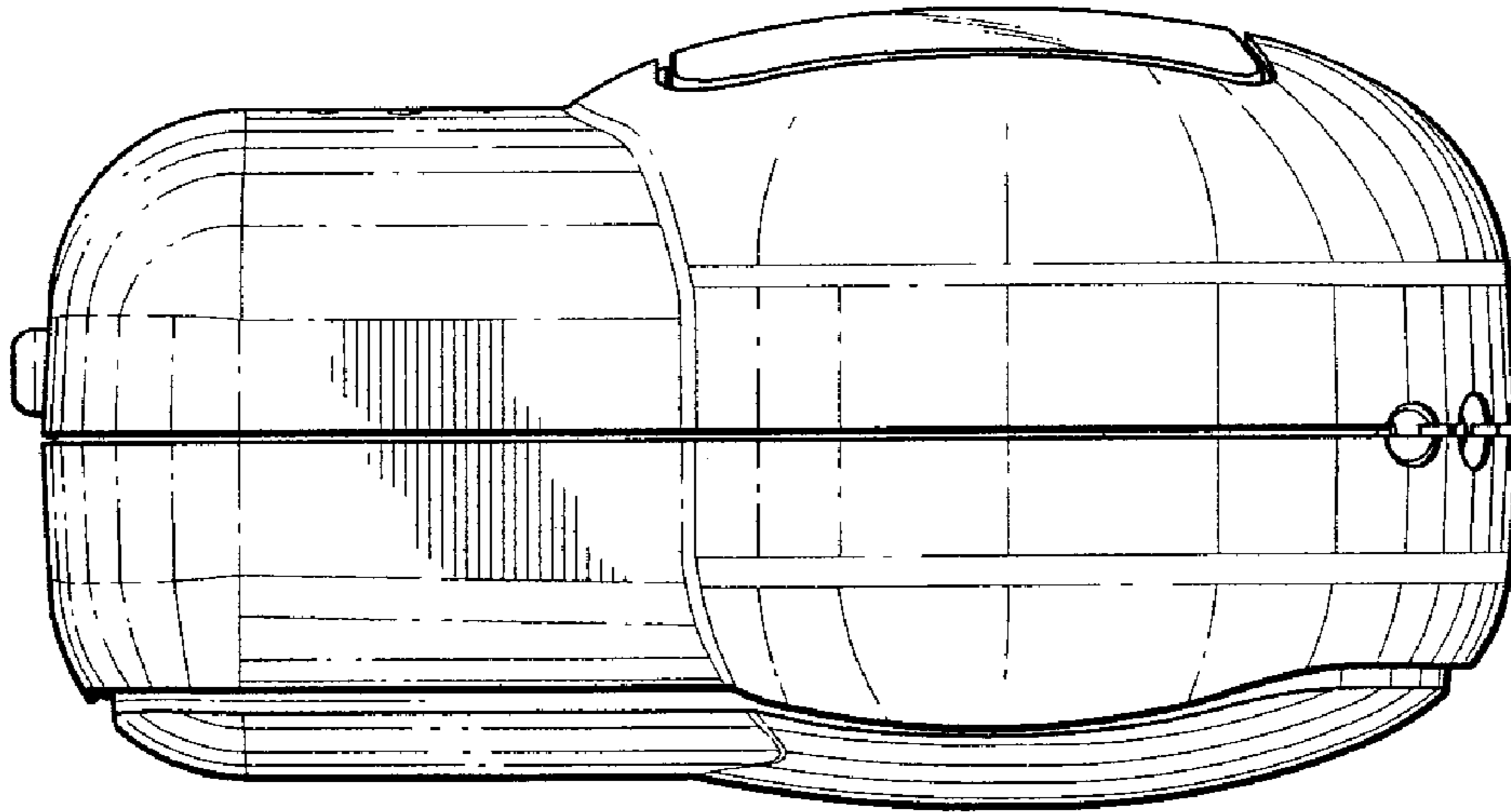

FIG. 4

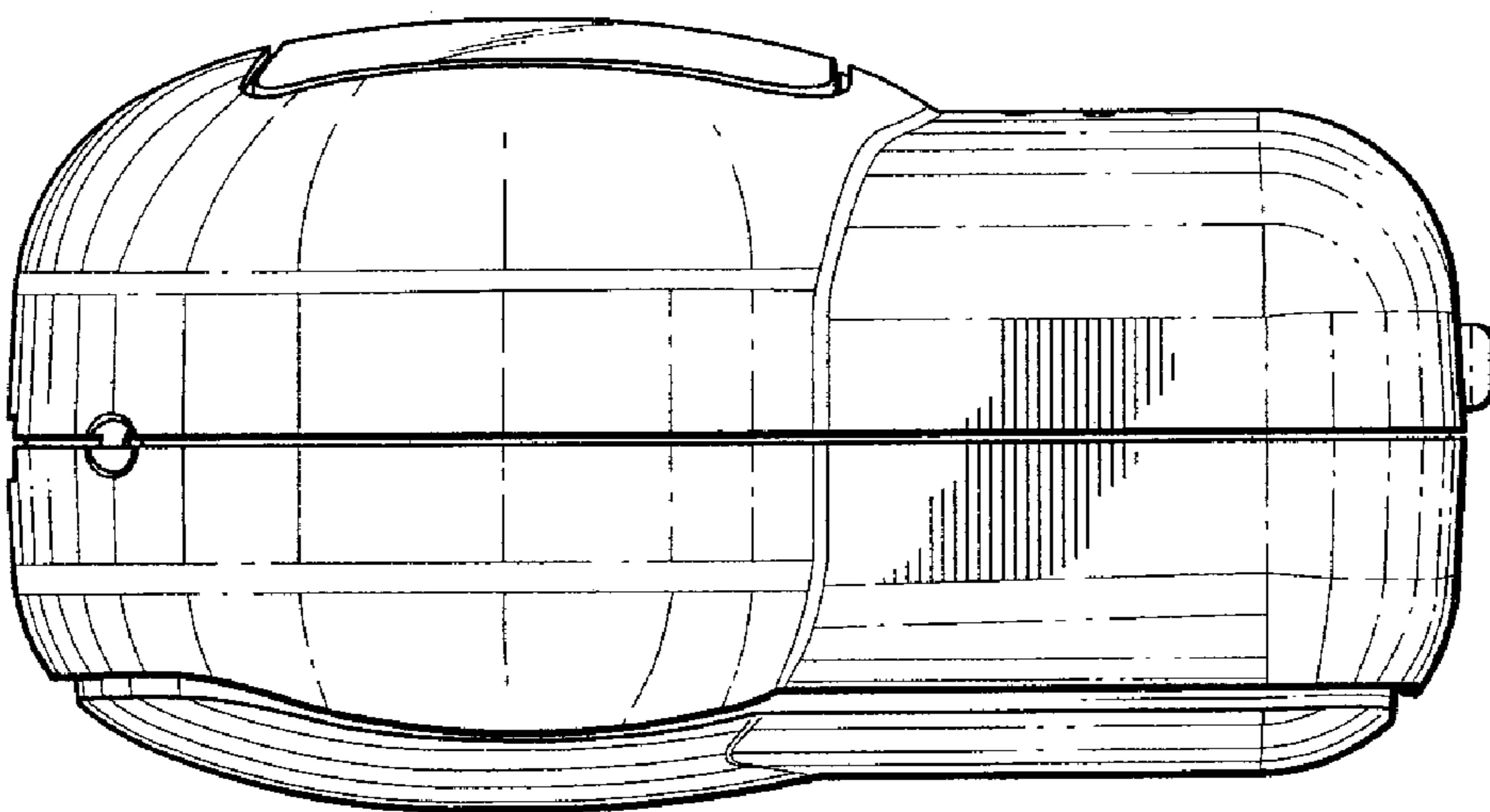

FIG. 5

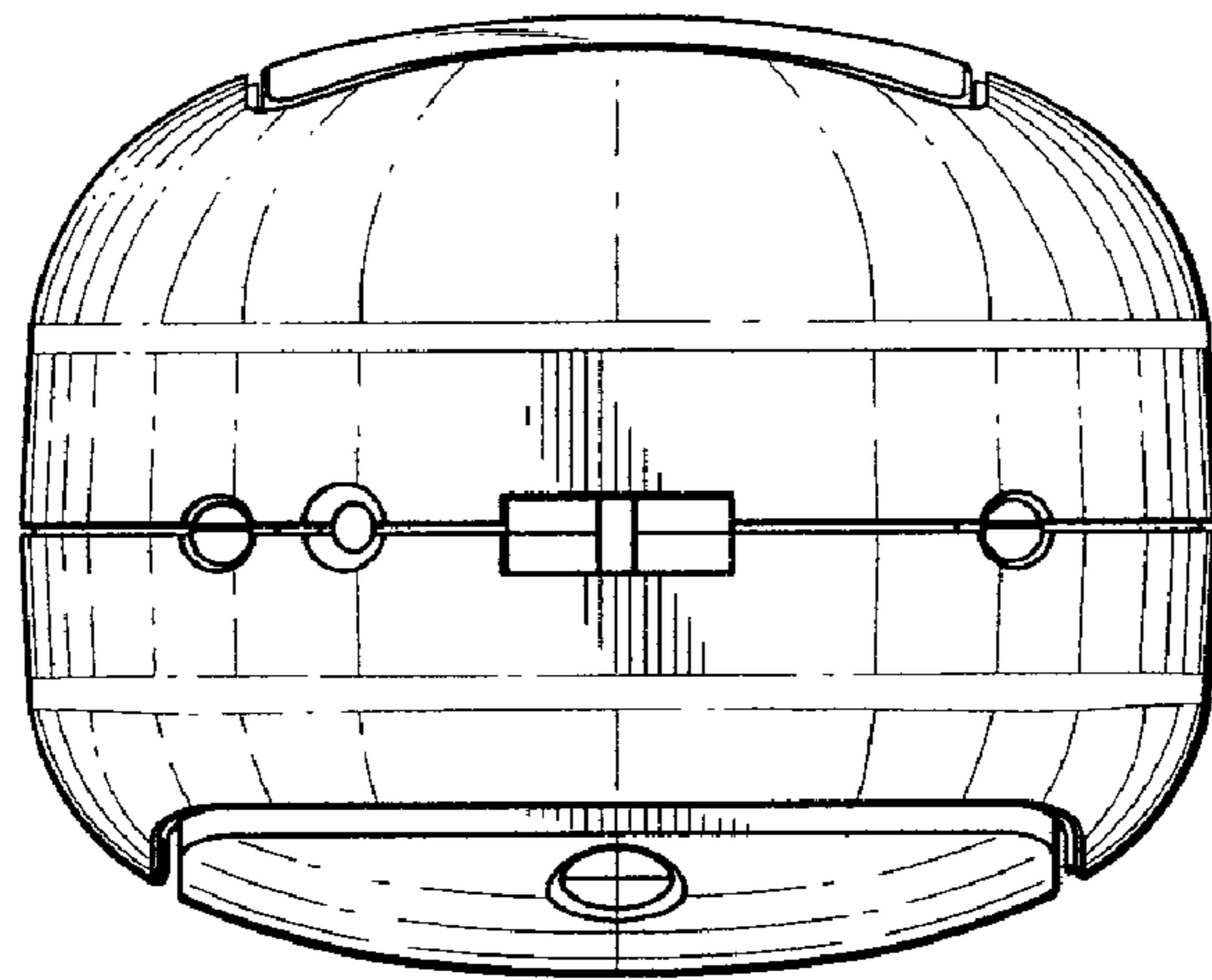

FIG. 6

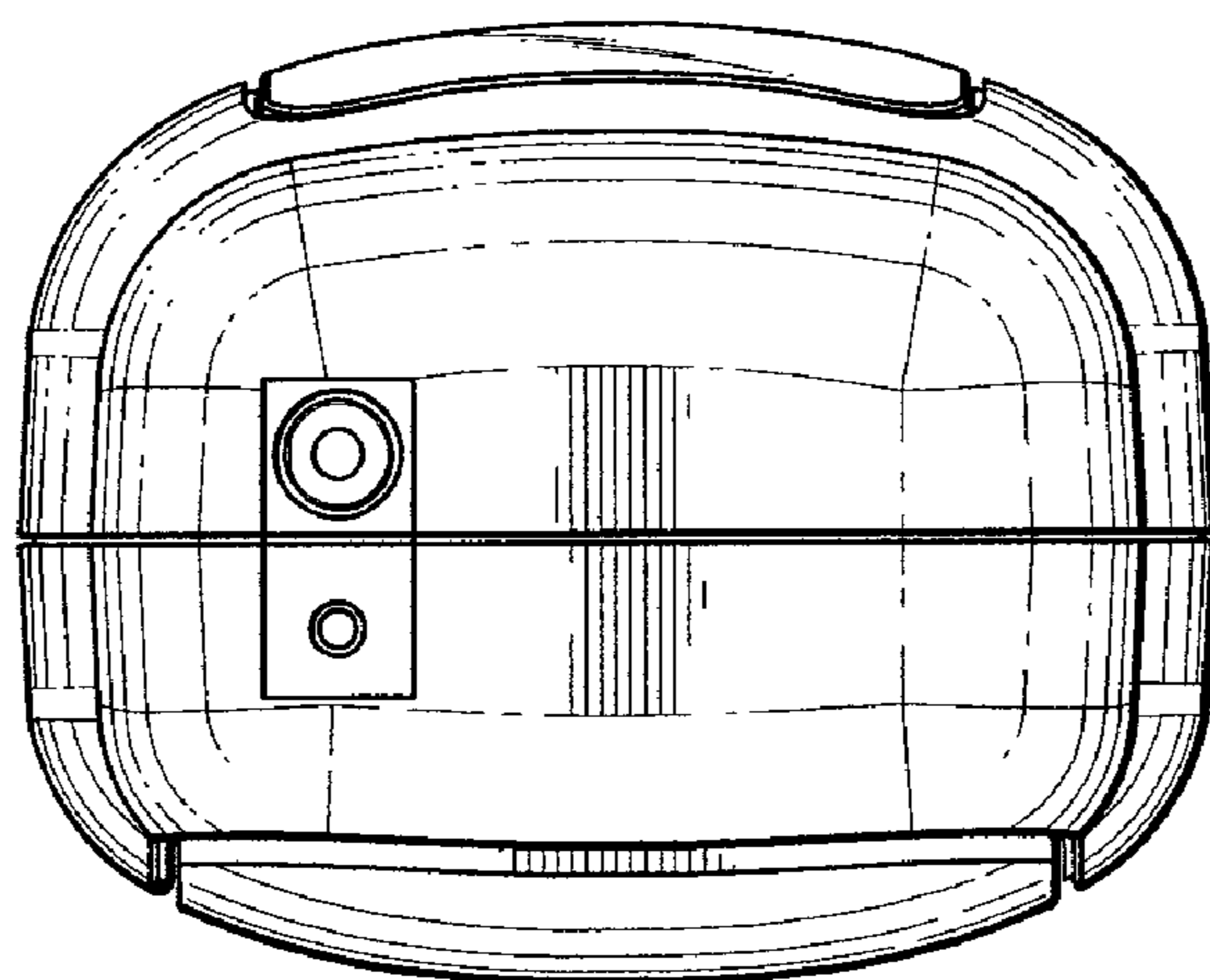

FIG. 7