



US00D581948S

(12) **United States Design Patent**  
**Takada et al.**

(10) **Patent No.:** **US D581,948 S**  
(45) **Date of Patent:** **\*\* Dec. 2, 2008**

(54) **VALVE MANIFOLD**

(75) Inventors: **Hideyuki Takada**, Tsukubamirai (JP);  
**Yoshihiko Ito**, Tsukubamirai (JP)

(73) Assignee: **SMC Corporation**, Chiyoda-ku, Tokyo  
(JP)

(\*\*) Term: **14 Years**

(21) Appl. No.: **29/285,745**

(22) Filed: **Apr. 9, 2007**

(30) **Foreign Application Priority Data**

Oct. 12, 2006 (JP) ..... 2006-027636

(51) **LOC (8) Cl.** ..... **15-01**

(52) **U.S. Cl.** ..... **D15/5**

(58) **Field of Classification Search** ..... D15/1-5;  
137/884, 625.65, 885, 883, 886, 560, 554;  
123/184.42, 184.46, 195 R

See application file for complete search history.

(56) **References Cited**

**U.S. PATENT DOCUMENTS**

3,495,624 A \* 2/1970 Kling ..... 137/637  
4,498,500 A \* 2/1985 Miller ..... 137/883  
6,427,723 B2 \* 8/2002 Bogdanowicz et al. .... 137/884  
6,453,948 B2 \* 9/2002 Notz et al. .... 137/884  
6,520,202 B2 \* 2/2003 Miyazoe et al. .... 137/554

6,830,067 B2 \* 12/2004 Hayashi ..... 137/554  
6,874,537 B2 \* 4/2005 Hayashi et al. .... 137/884  
7,048,002 B2 \* 5/2006 Hayashi et al. .... 137/560  
7,162,884 B2 \* 1/2007 Alles ..... 62/178  
2001/0037832 A1 \* 11/2001 Weiss et al. .... 137/627.5  
2004/0154674 A1 \* 8/2004 Pieper ..... 137/884

\* cited by examiner

*Primary Examiner*—Ian Simmons

*Assistant Examiner*—Wan Laymon

(74) *Attorney, Agent, or Firm*—Yokoi & Co., U.S.A., Inc.;  
Peter Ganjian

(57) **CLAIM**

The ornamental design for a valve manifold, as shown and described.

**DESCRIPTION**

FIG. 1 is a front view of a valve manifold showing our new design;

FIG. 2 is a rear view thereof;

FIG. 3 is a top view thereof;

FIG. 4 is a bottom view thereof;

FIG. 5 is a right side view thereof;

FIG. 6 is a left side view thereof; and,

FIG. 7 is a perspective view thereof.

**1 Claim, 7 Drawing Sheets**

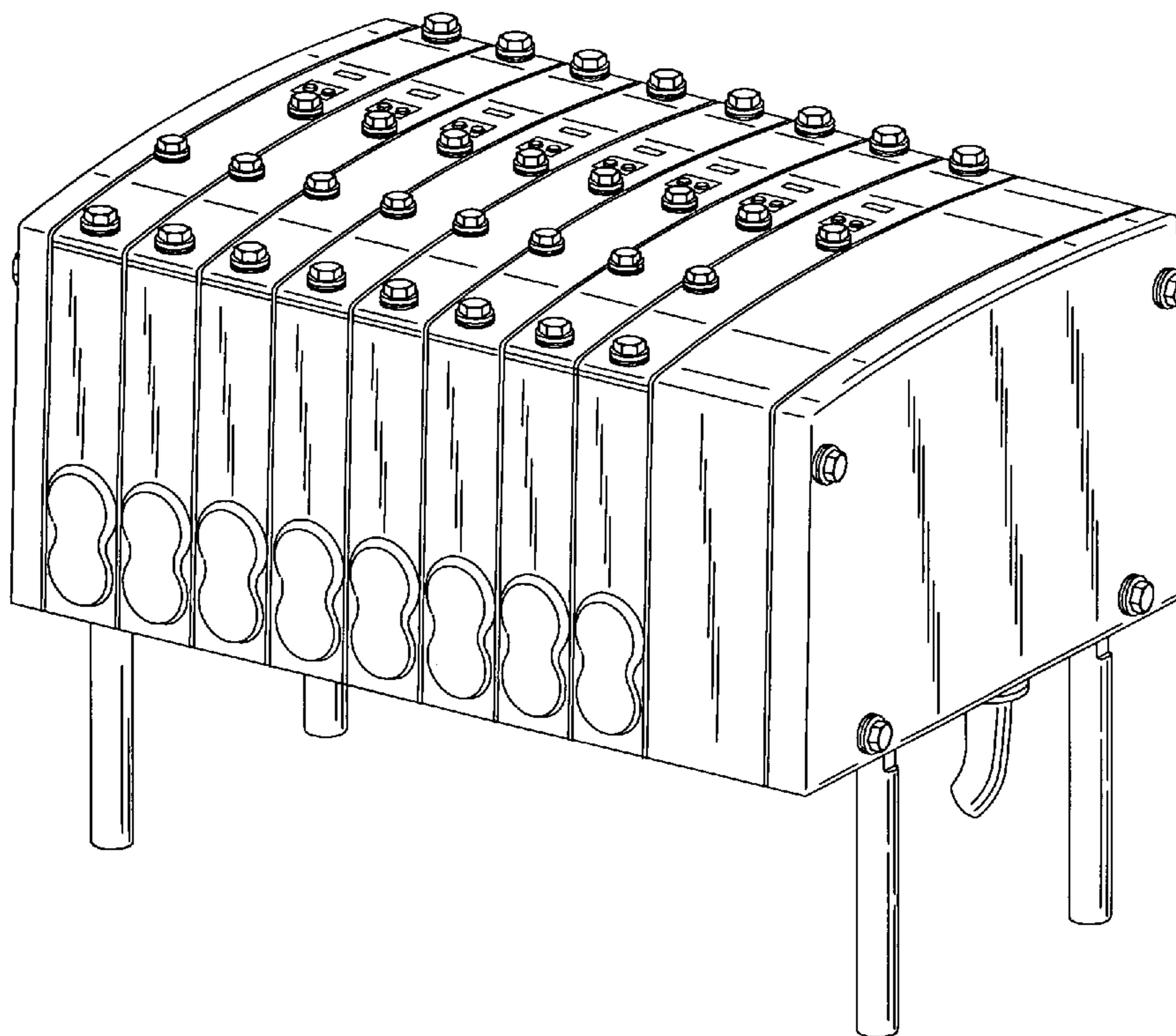

FIG. 1

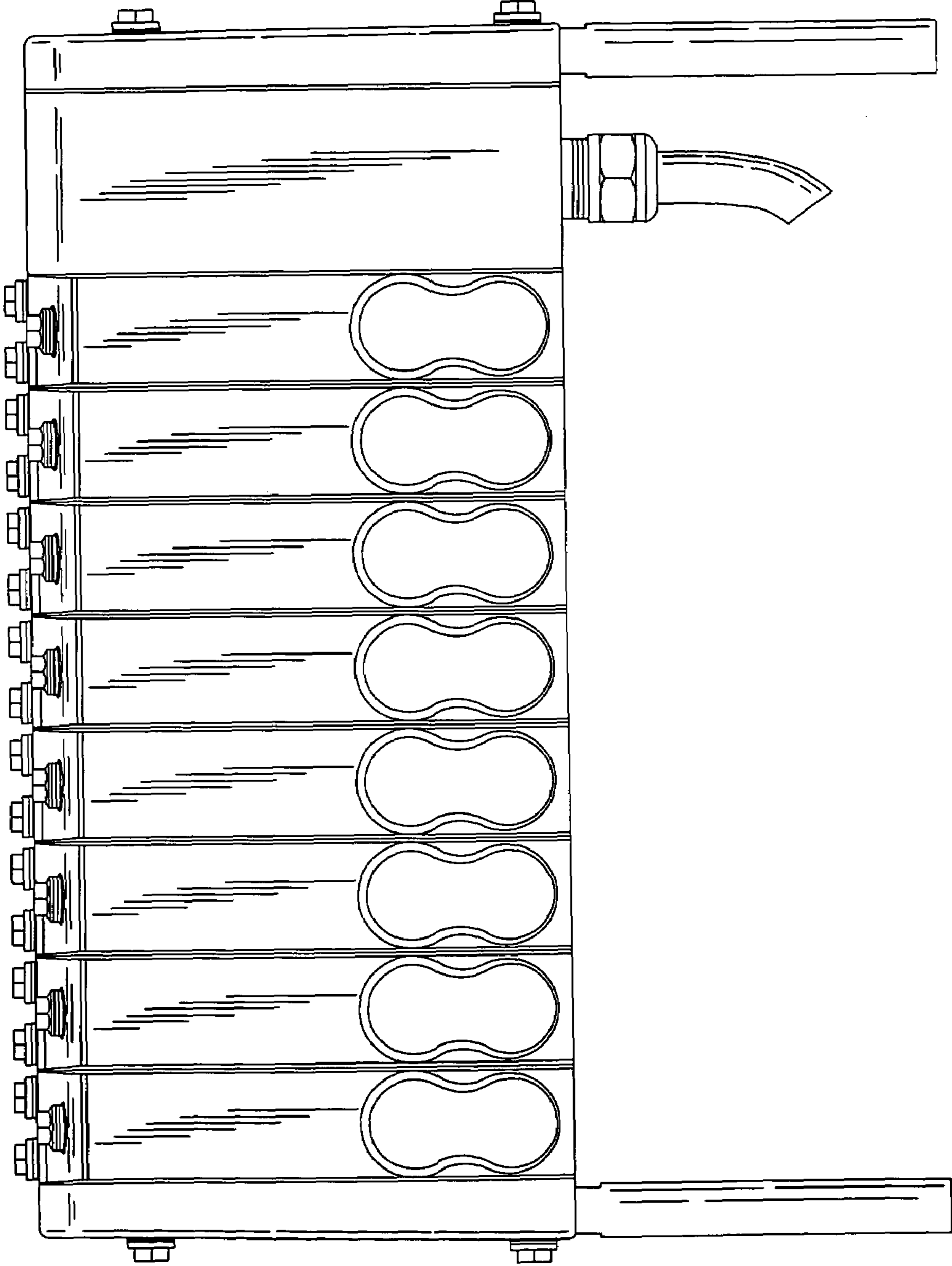

FIG. 2

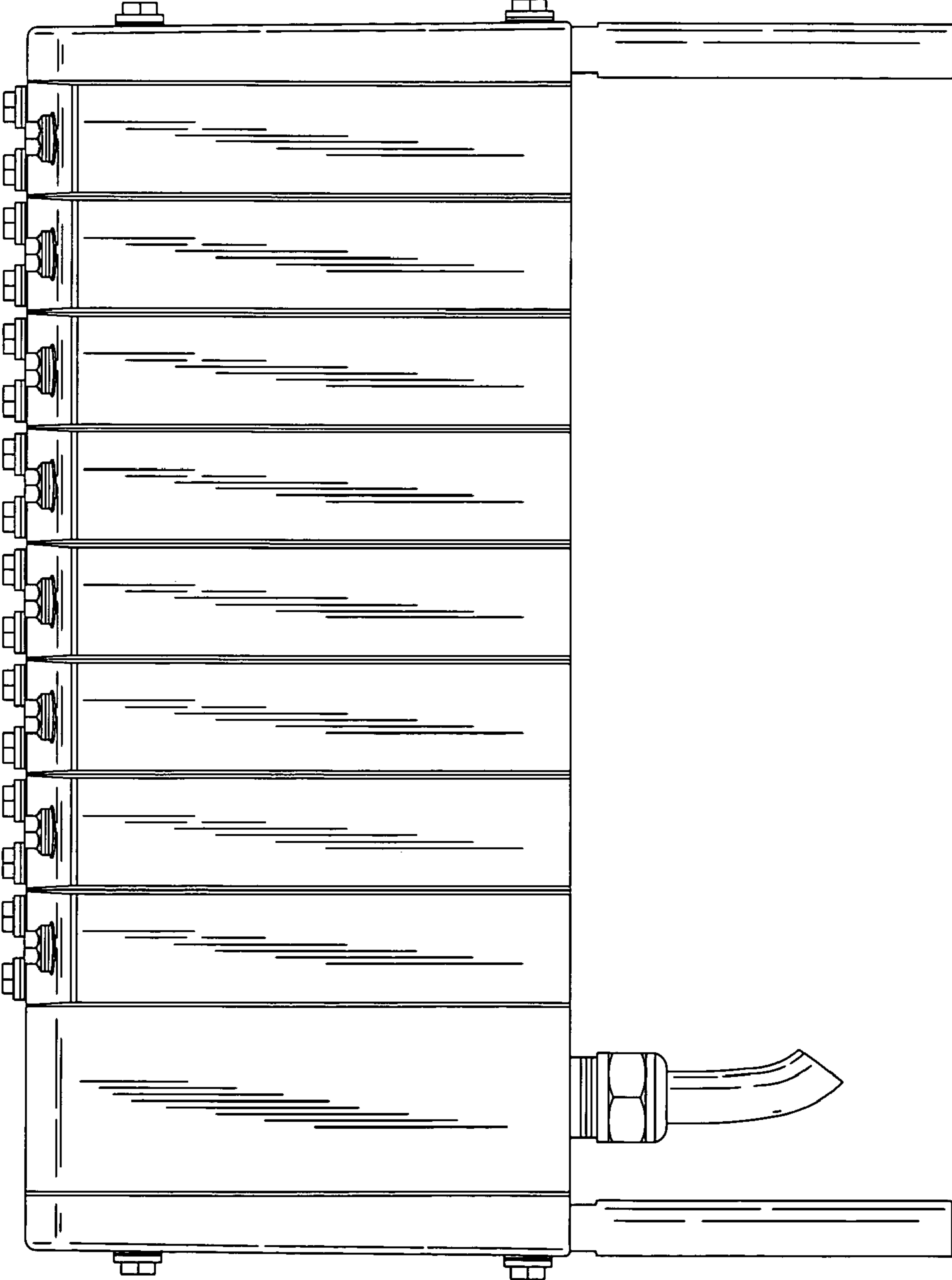

FIG. 3

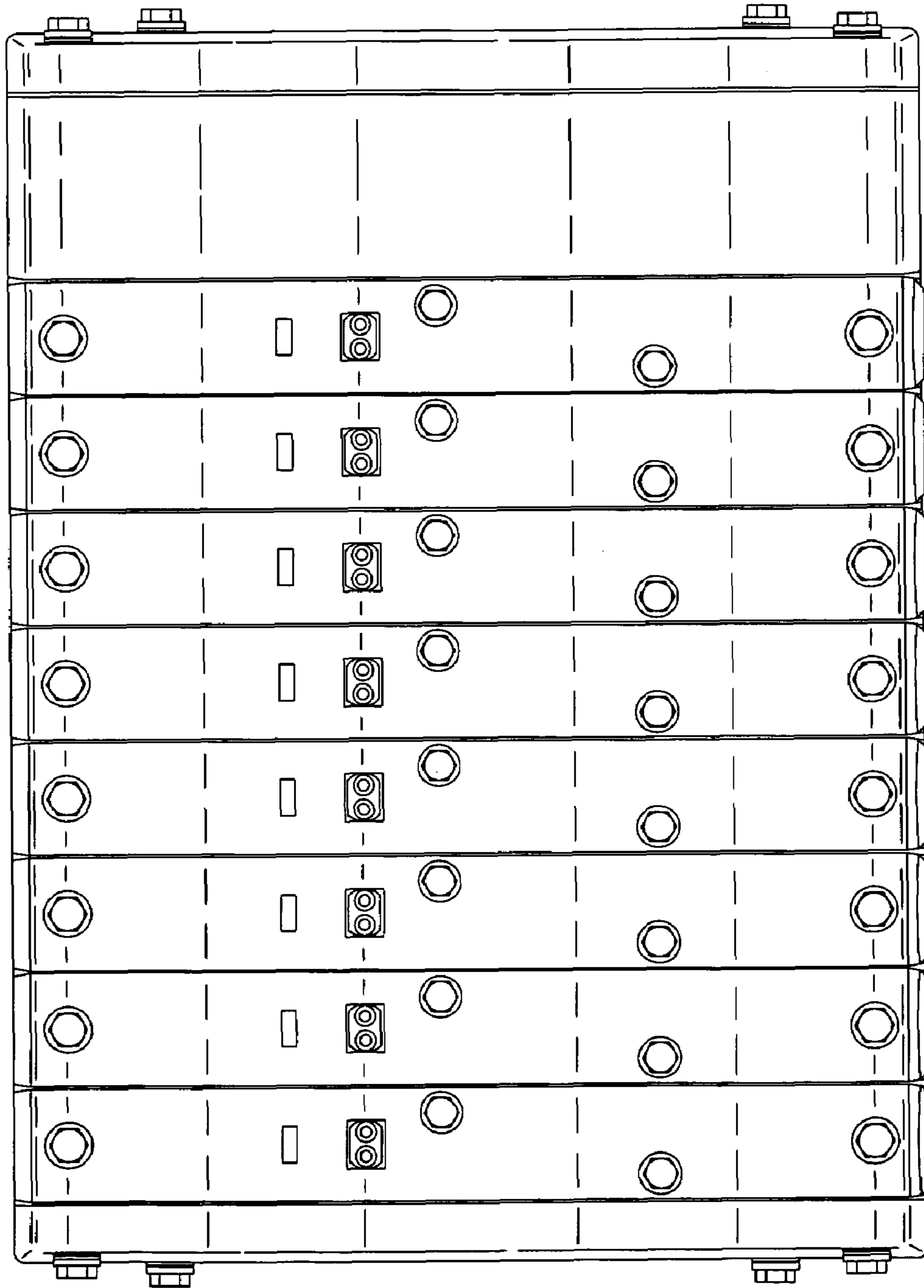

FIG. 4

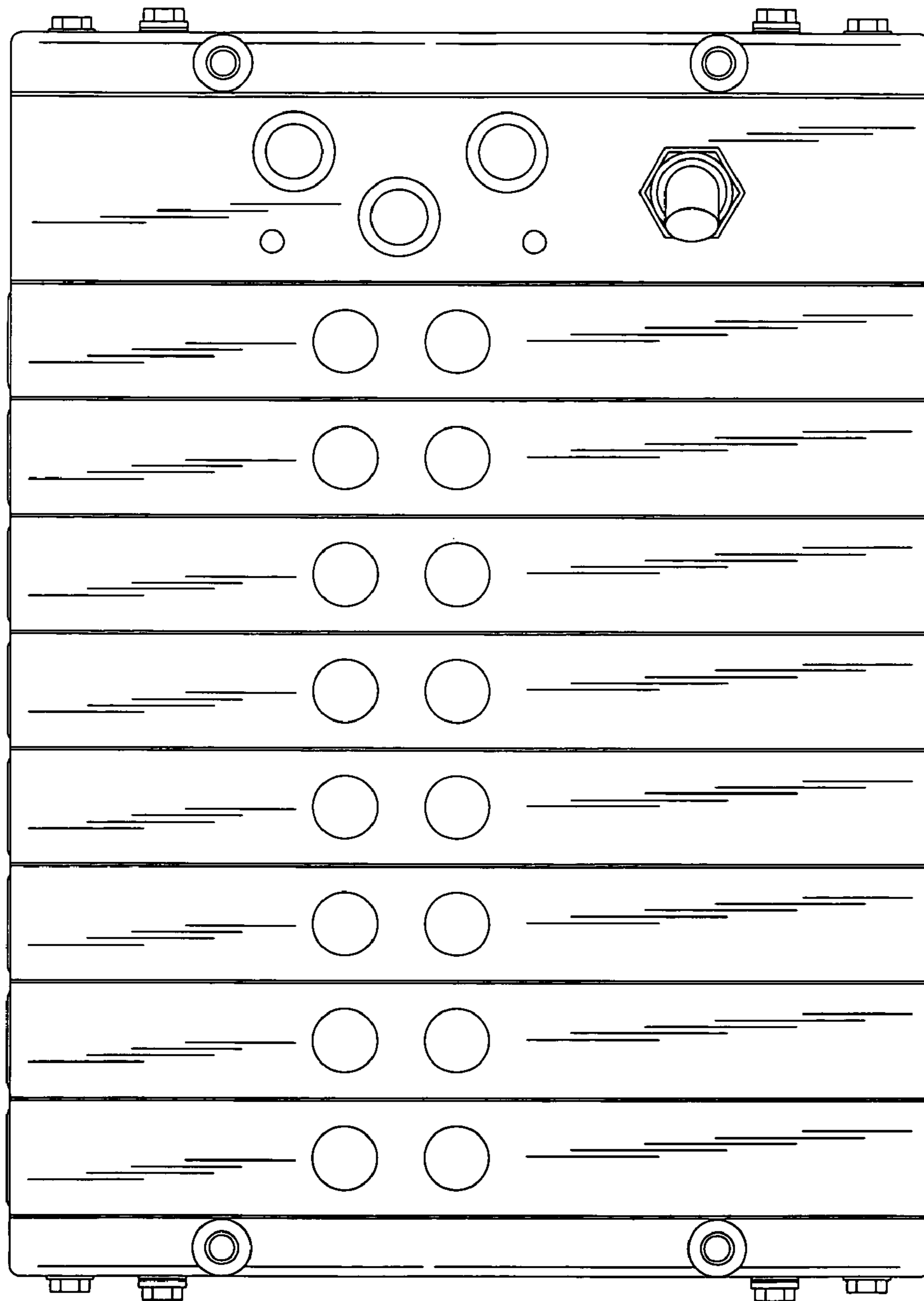

FIG. 5

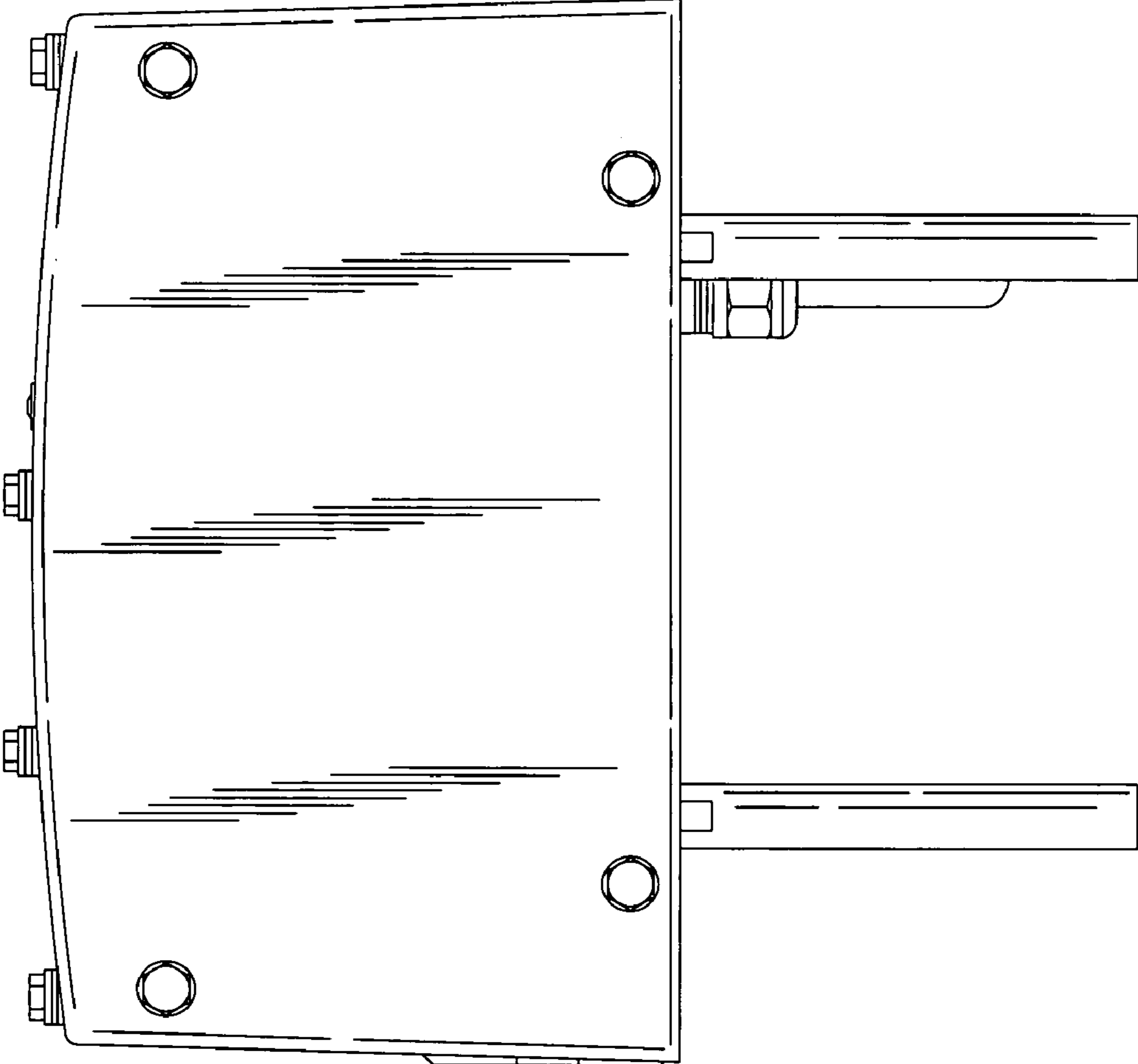

FIG. 6

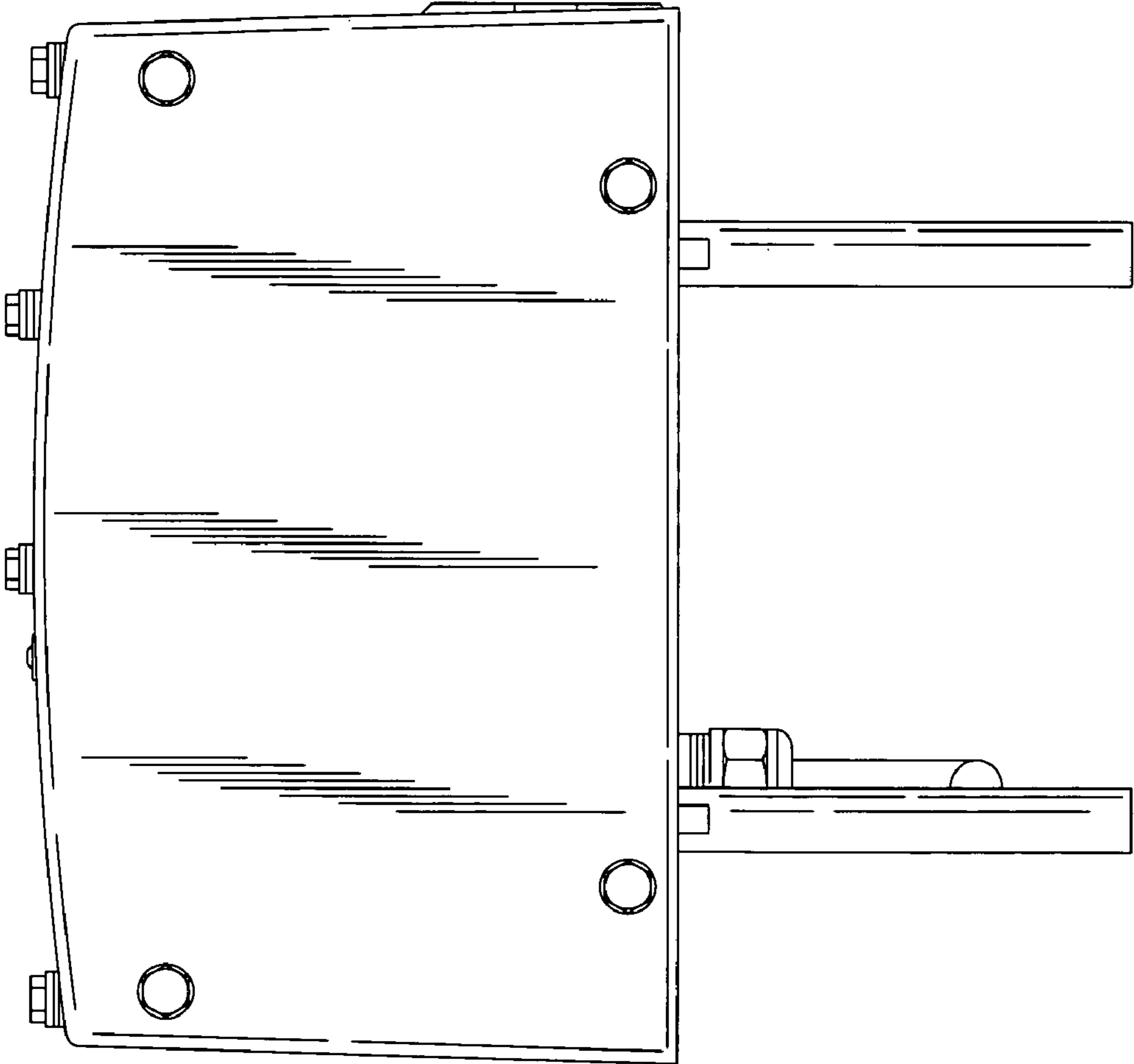



FIG. 7

