



US00D581876S

(12) **United States Design Patent**
Hatano et al.

(10) **Patent No.:** **US D581,876 S**
(45) **Date of Patent:** **** Dec. 2, 2008**

(54) **ELECTRICAL CONNECTOR**

FOREIGN PATENT DOCUMENTS

(75) Inventors: **Takahiro Hatano**, Tokyo (JP); **Makiya Kimura**, Tokyo (JP); **Tomoyuki Takamoto**, Gunma (JP); **Shin Sakiyama**, Saitama (JP); **Takashi Sekizuka**, Saitama (JP)

JP 3-12383 2/1991
JP 11-126667 11/1999

* cited by examiner

Primary Examiner—Daniel D Bui
(74) *Attorney, Agent, or Firm*—Barley Snyder LLC

(73) Assignees: **Tyco Electronics AMP K.K.**, Kanagawa-ken (JP); **Advantest Corporation**, Tokyo (JP)

(57) **CLAIM**

The ornamental design for an electrical connector, as shown and described.

(**) Term: **14 Years**

DESCRIPTION

(21) Appl. No.: **29/304,411**

FIG. 1 is a front elevation view of an electrical connector, showing our new design;

(22) Filed: **Feb. 29, 2008**

FIG. 2 is a rear elevation view thereof;

(51) **LOC (8) Cl.** **13-03**

FIG. 3 is a left side elevation view thereof,

(52) **U.S. Cl.** **D13/147**

FIG. 4 is a right side elevation view thereof;

(58) **Field of Classification Search** D13/146-147,
D13/154, 184; 439/64, 79, 157, 159-160,
439/325, 329, 395, 492, 496, 521, 607-610,
439/630

FIG. 5 is a top plan view thereof;

FIG. 6 is a bottom plan view thereof;

See application file for complete search history.

FIG. 7 is a cross sectional view thereof taken along the line 7-7 in FIG. 1 thereof;

FIG. 8 is a cross sectional view thereof taken along the line 8-8 in FIG. 1 thereof;

(56) **References Cited**

U.S. PATENT DOCUMENTS

D505,920 S *	6/2005	Moritake	D13/147
D508,023 S *	8/2005	Obikane et al.	D13/147
D528,987 S *	9/2006	Peng	D13/147
D533,506 S *	12/2006	Peng	D13/147
D543,944 S *	6/2007	Yamada et al.	D13/147
D562,770 S *	2/2008	Obikane	D13/147

FIG. 9 is a top, front, and right side perspective view thereof; and,

FIG. 10 is a bottom, front, and left side perspective view thereof.

1 Claim, 10 Drawing Sheets

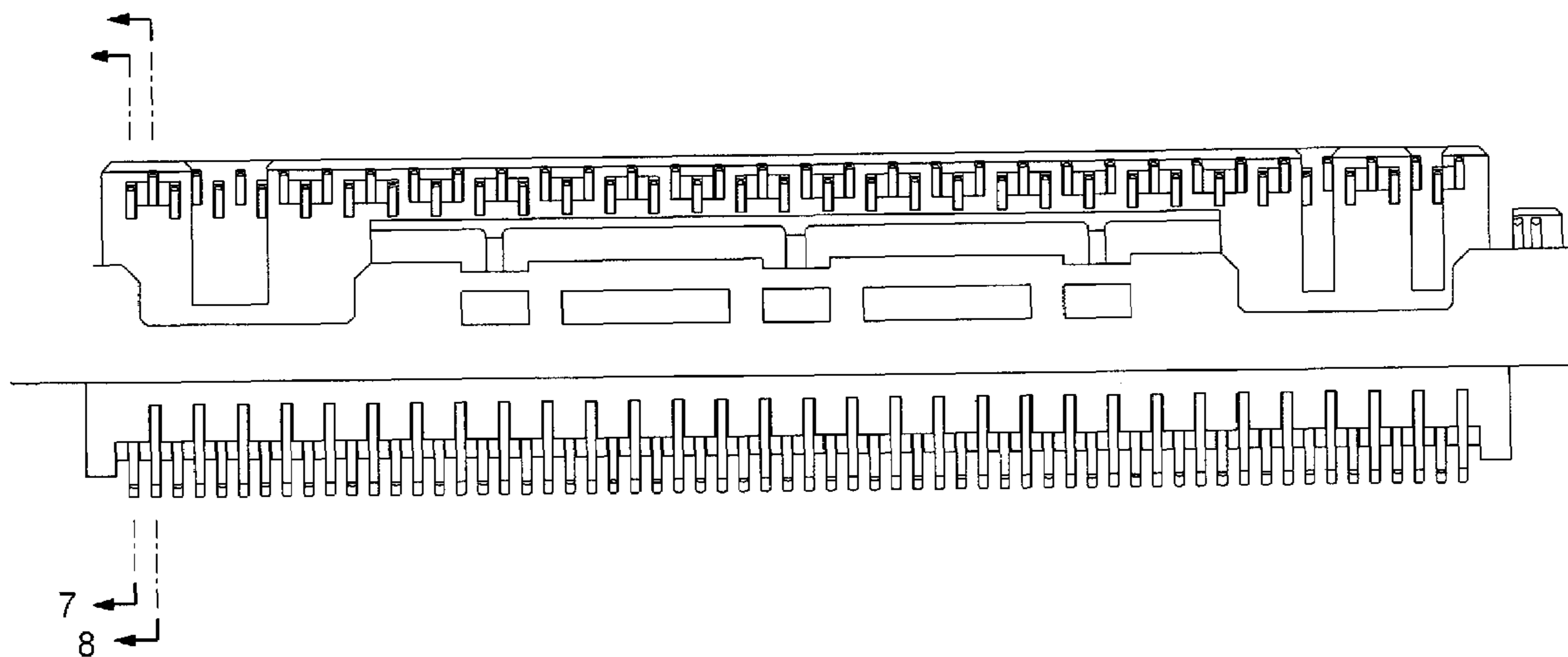

FIG. 1

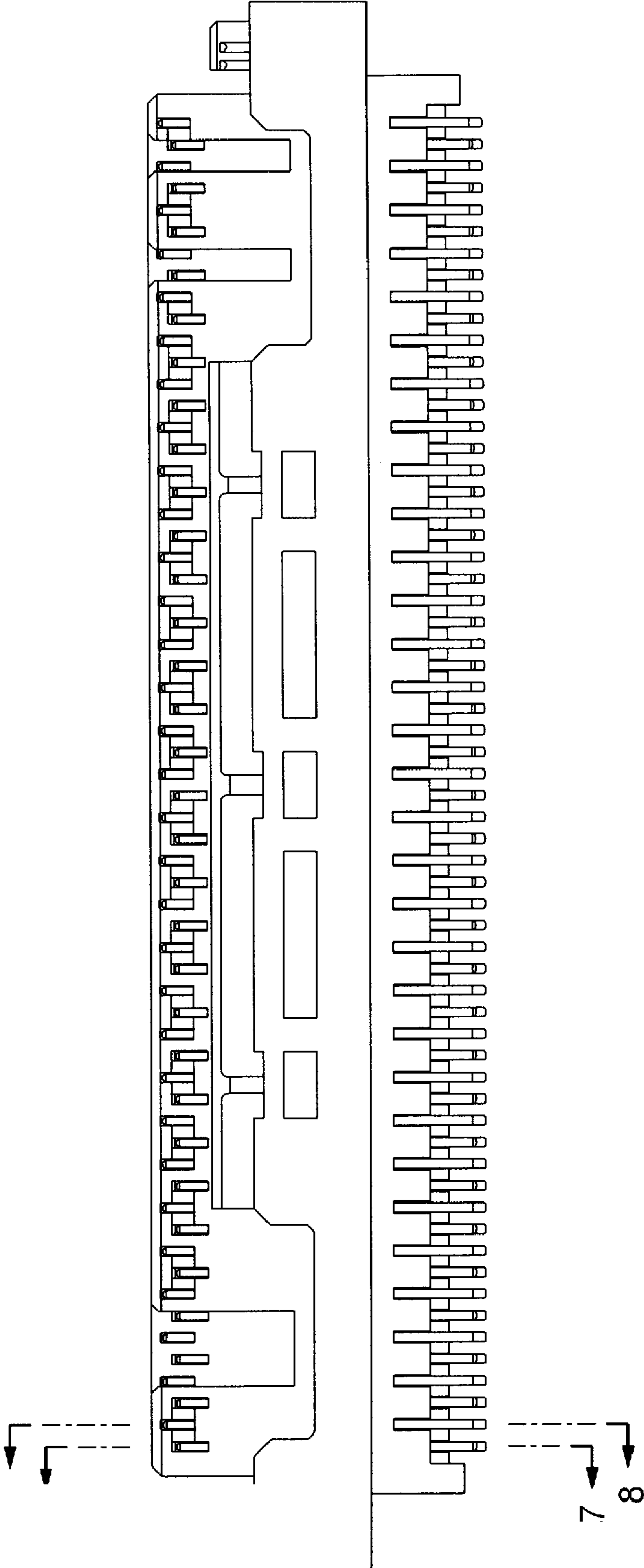

FIG. 2

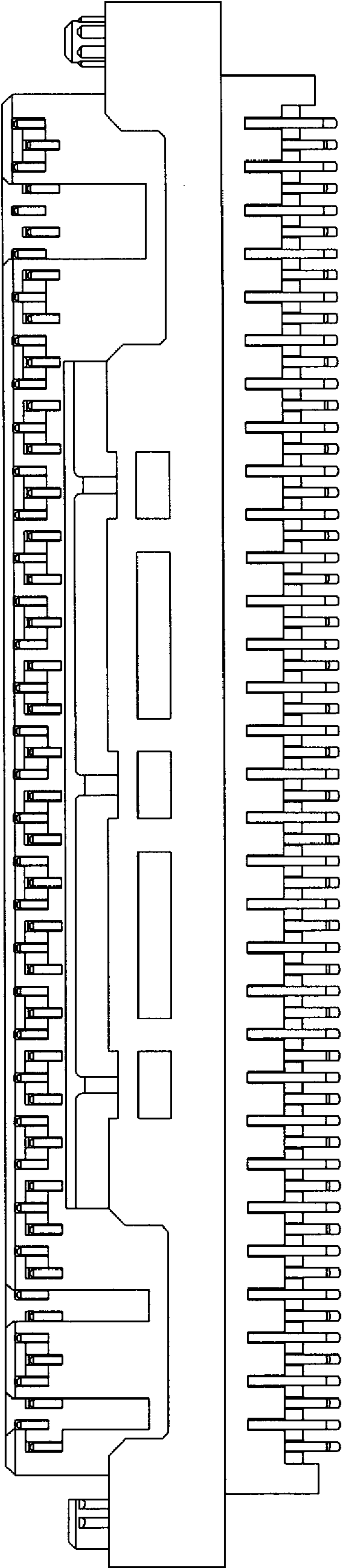

FIG. 3

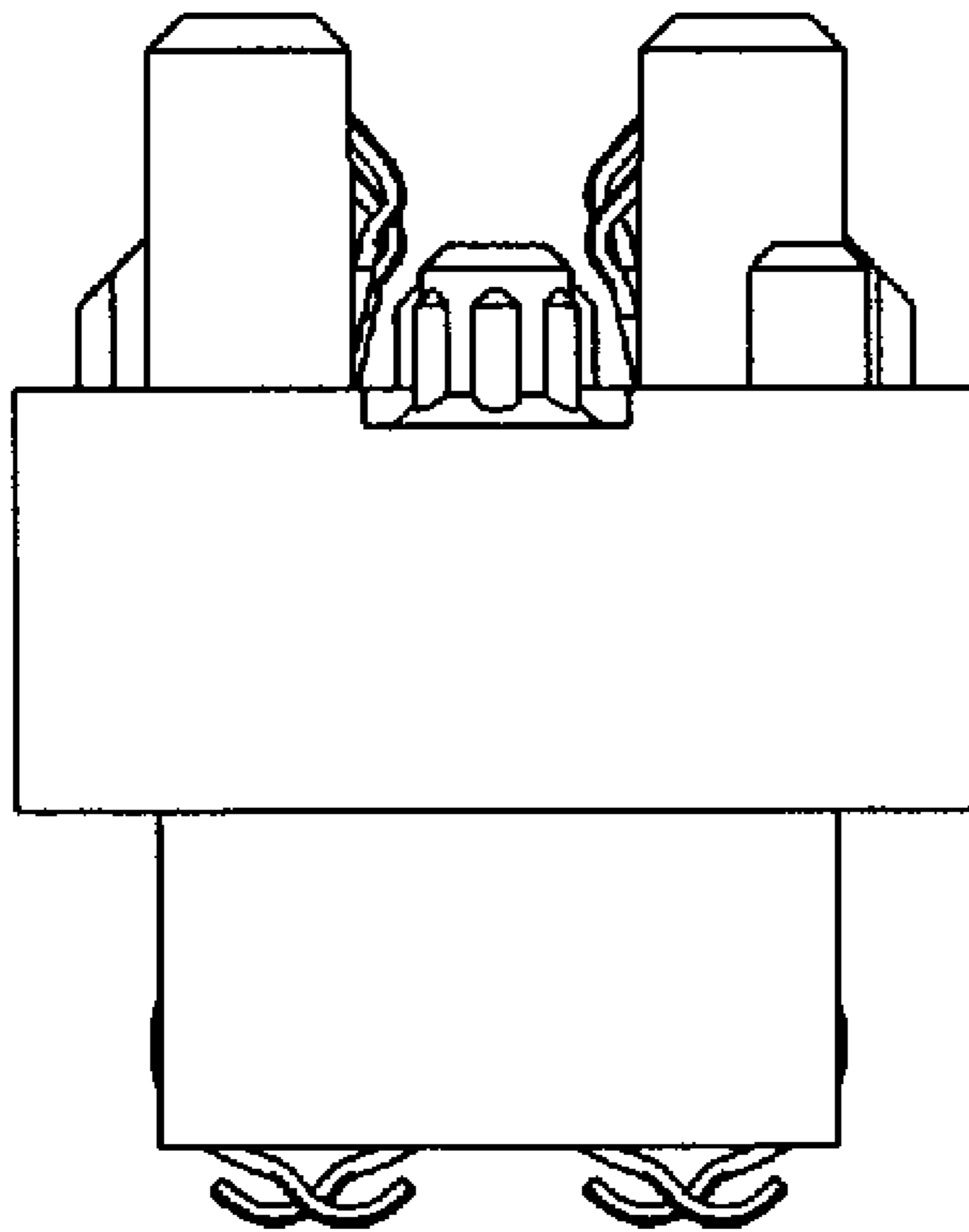

FIG. 4

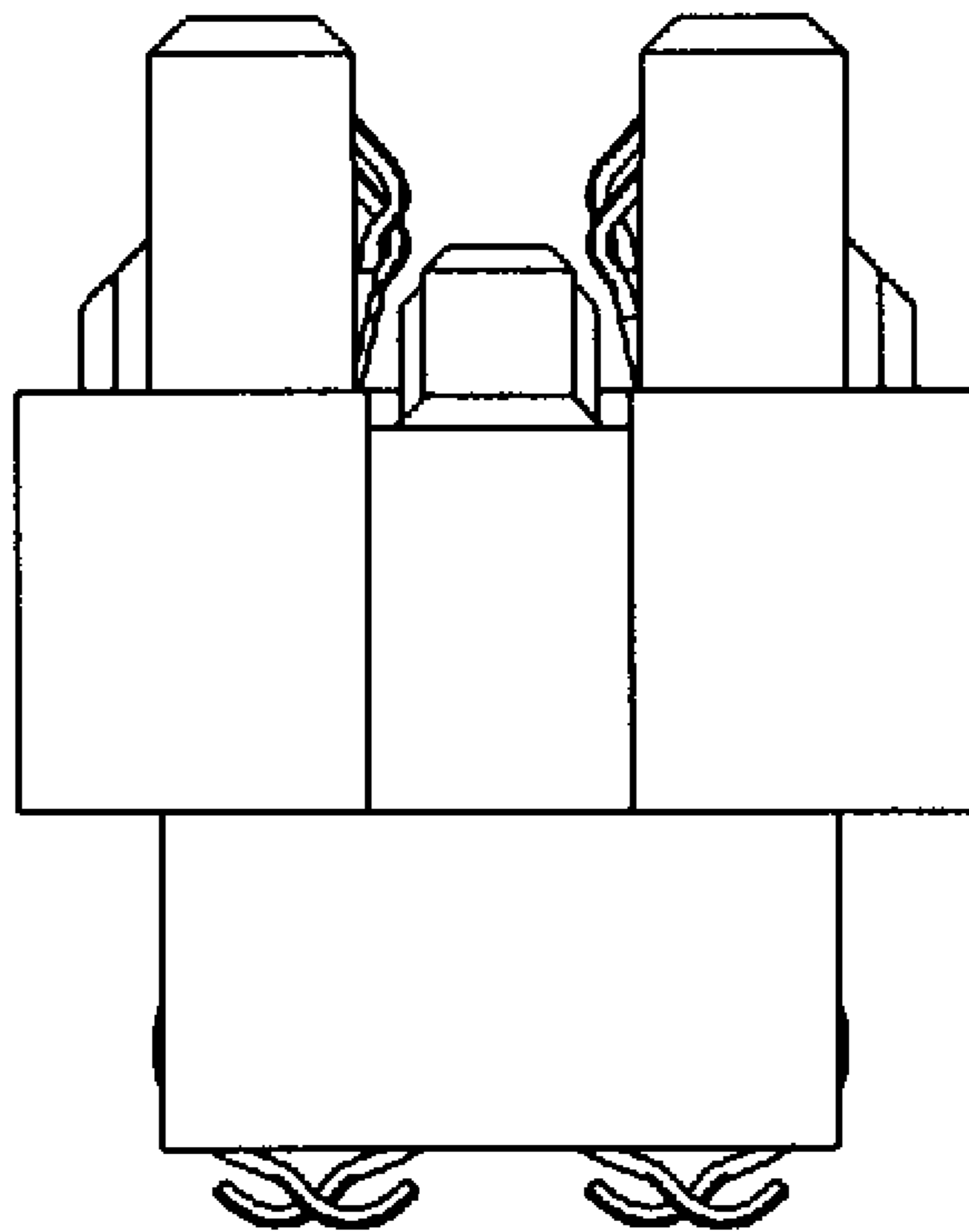

FIG. 5

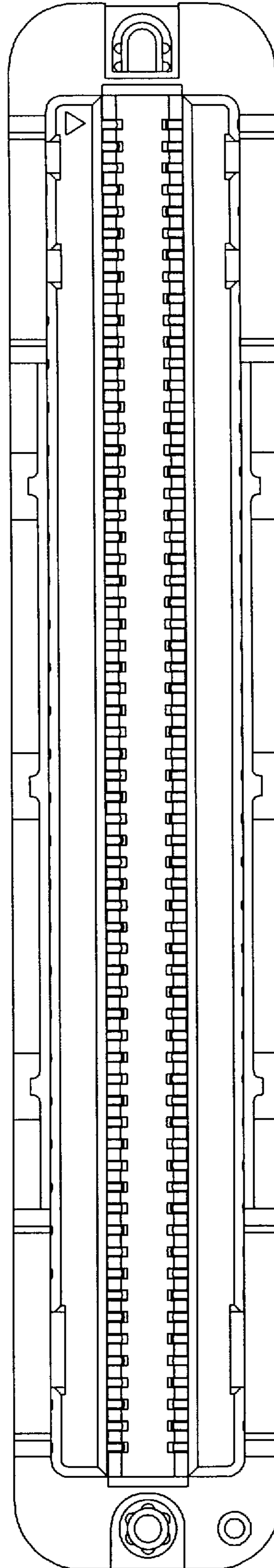

FIG. 6

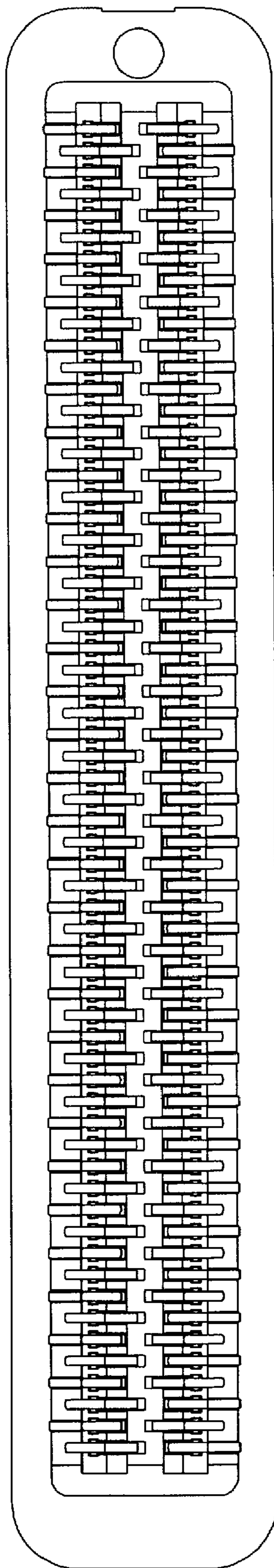

FIG. 7

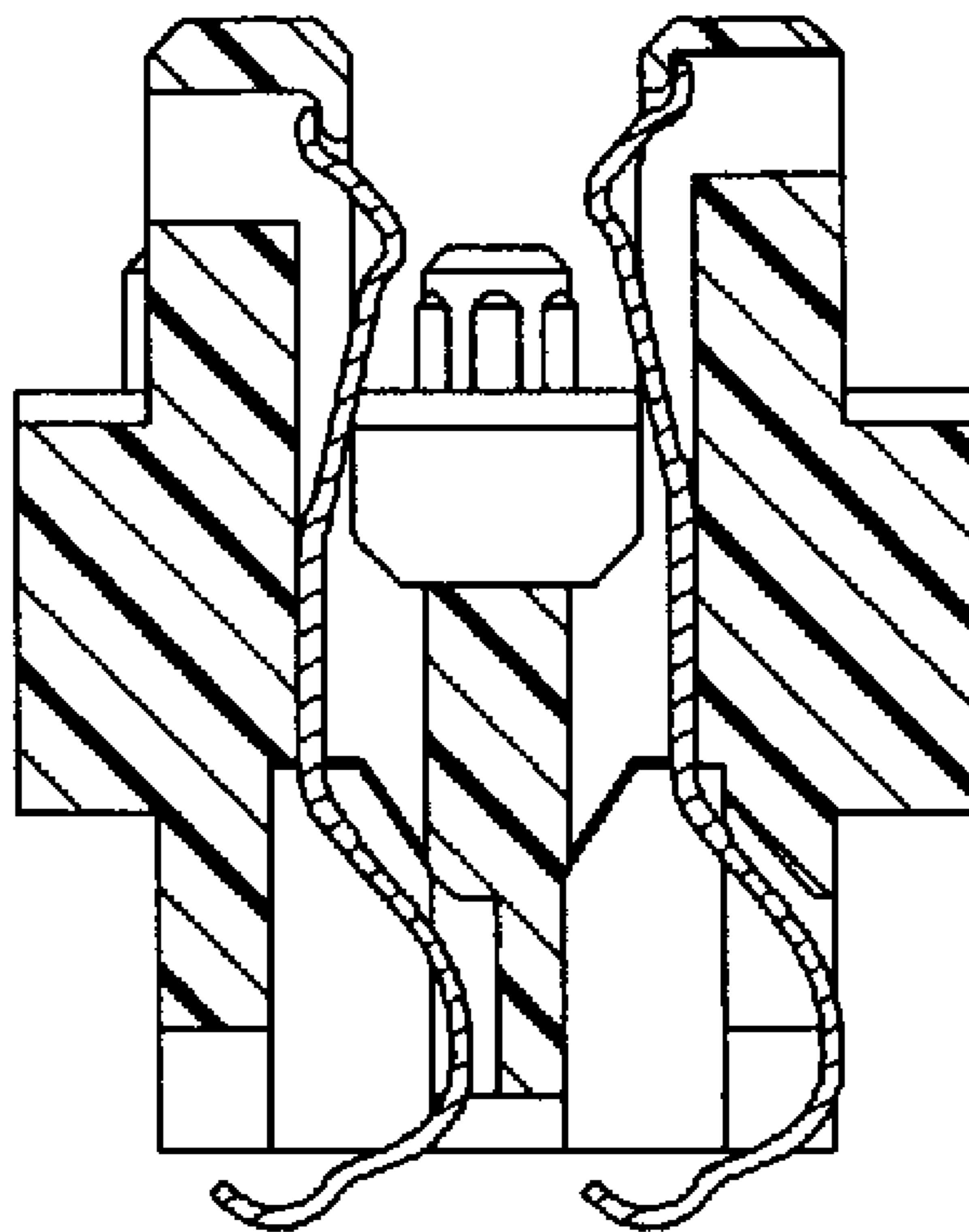

FIG. 8

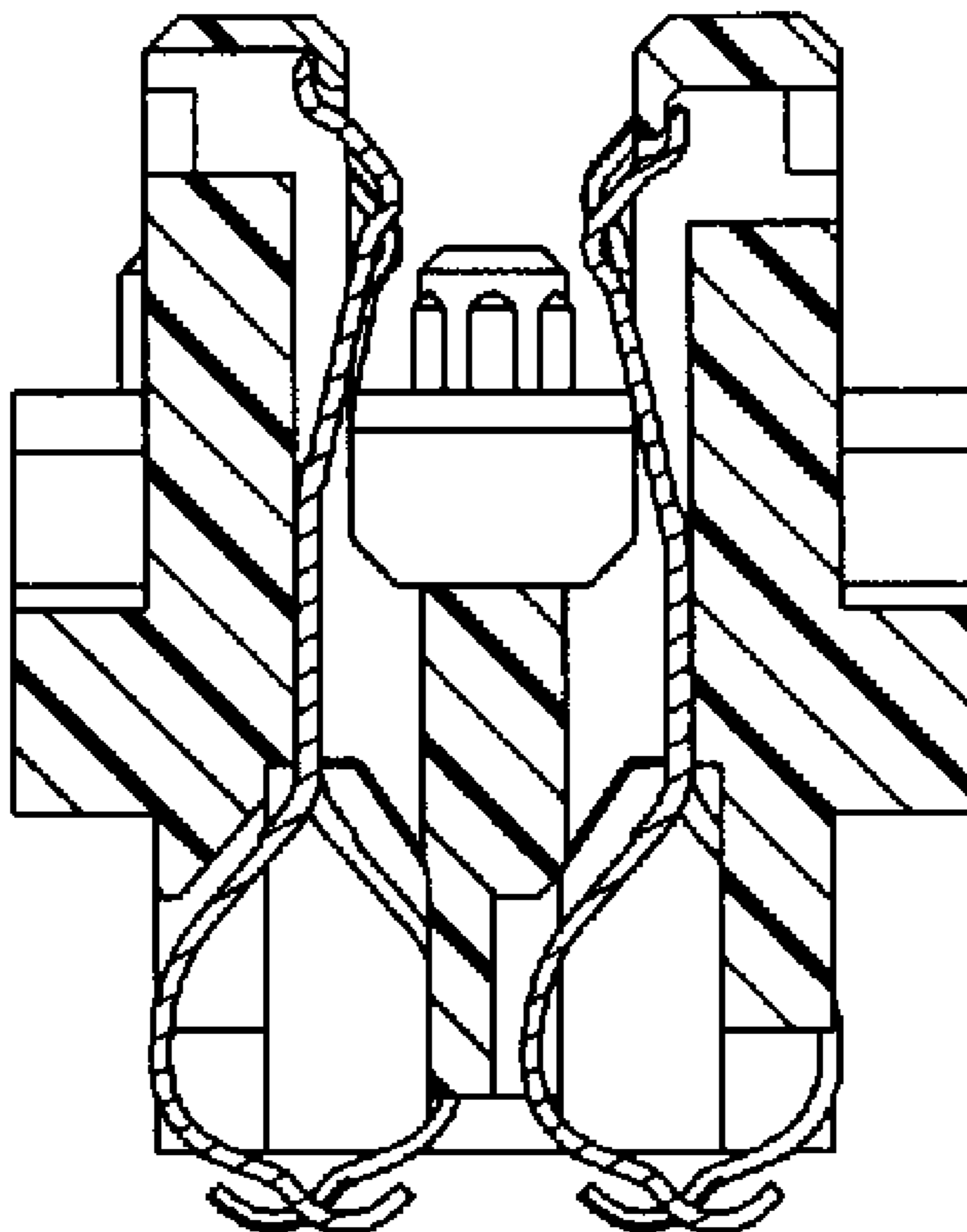

FIG. 9

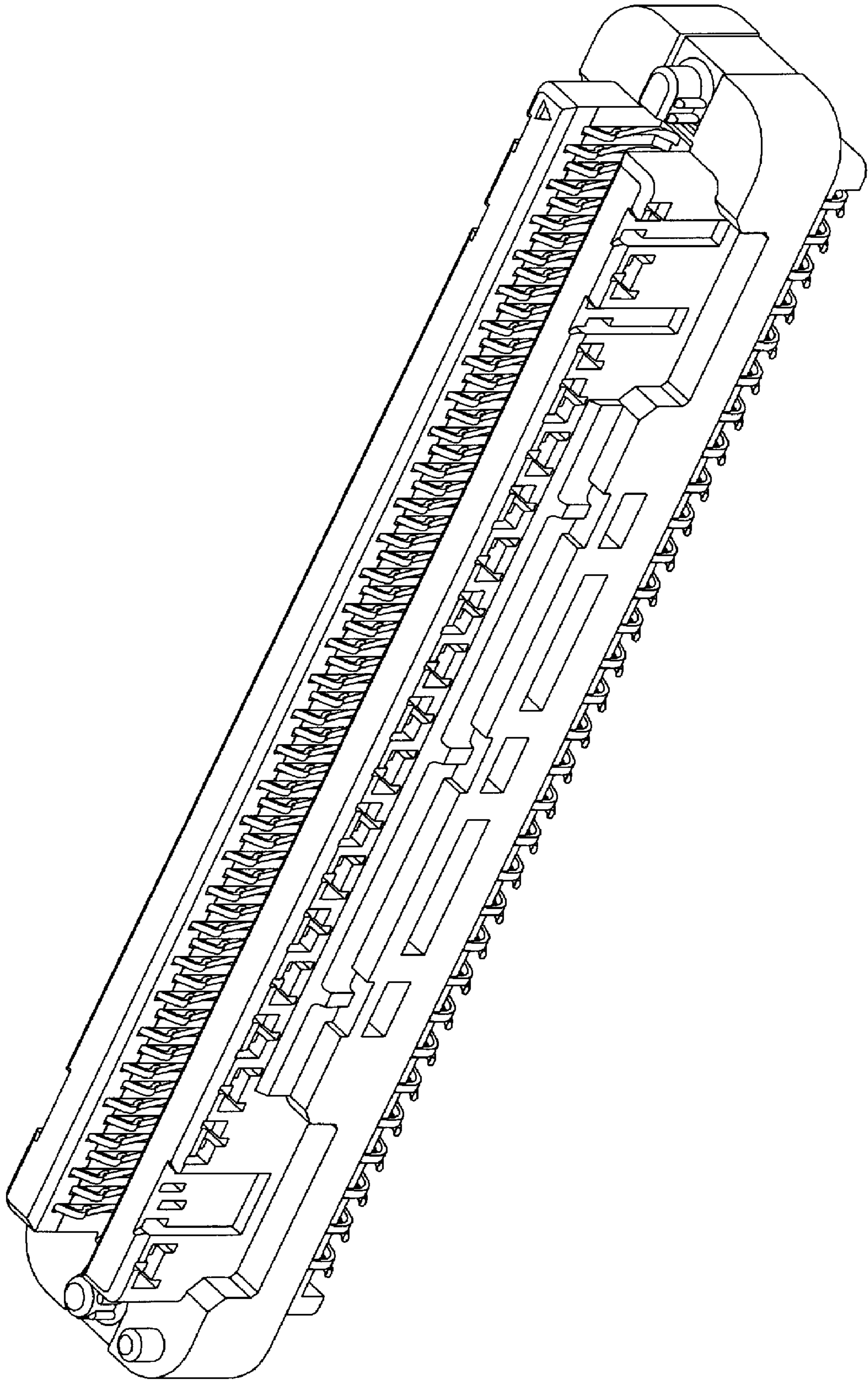

FIG. 10

