



US00D581732S

(12) **United States Design Patent**  
**Epstein**

(10) **Patent No.:** **US D581,732 S**  
(45) **Date of Patent:** **\*\* Dec. 2, 2008**

(54) **ROUND-ENDED SANTOKU KNIFE**  
(75) Inventor: **Dennis L. Epstein**, Ridgefield, WA (US)  
(73) Assignee: **KAI U.S.A., Ltd.**, Tualatin, OR (US)  
(\*\*) Term: **14 Years**  
(21) Appl. No.: **29/303,533**  
(22) Filed: **Feb. 11, 2008**

D525,088 S \* 7/2006 Fort et al. .... D7/652  
D545,637 S 7/2007 Curtin  
D552,430 S \* 10/2007 Chen ..... D7/649  
D554,437 S \* 11/2007 Ono ..... D7/649  
D554,438 S 11/2007 Ono  
D554,949 S \* 11/2007 Hood ..... D7/650

\* cited by examiner

*Primary Examiner*—Caron D. Veynar  
*Assistant Examiner*—Ricky Pham  
(74) *Attorney, Agent, or Firm*—Seed IP Law Group PLLC

(51) **LOC (8) Cl.** ..... **07-03**  
(52) **U.S. Cl.** ..... **D7/401.2**  
(58) **Field of Classification Search** ..... D7/393,  
D7/395, 401.2, 642–646, 649–653, 662–664,  
D7/688, 695–696; D8/300, 303; 30/123.5–123.7,  
30/124–125, 128, 142–143, 147–149, 304,  
30/316, 342–346, 353, 355, 394  
See application file for complete search history.

(57) **CLAIM**

The ornamental design for a round-ended santoku knife, as shown and described.

**DESCRIPTION**

FIG. 1 is a front-side perspective view of a round-ended santoku knife showing my new design.  
FIG. 2 is a rear elevational view thereof.  
FIG. 3 is a right side elevational view thereof.  
FIG. 4 is a front elevational view thereof.  
FIG. 5 is a left side elevational view thereof.  
FIG. 6 is a bottom plan view thereof; and,  
FIG. 7 is a top plan view thereof.

Stippling and shading lines shown in the drawings are intended to represent the approximate three-dimensional contour of the design, and are not intended to indicate surface decoration. Features depicted in broken lines form no part of the claimed design.

(56) **References Cited**

**U.S. PATENT DOCUMENTS**

D125,774 S \* 3/1941 Madan ..... D7/650  
2,279,833 A \* 4/1942 Madan ..... 30/353  
2,315,898 A \* 4/1943 Krilow ..... 30/351  
2,803,876 A \* 8/1957 Nelson ..... 30/115  
5,572,794 A 11/1996 Kalbern  
D403,204 S \* 12/1998 Kwok ..... D7/401.2  
D403,559 S 1/1999 Terenzio  
6,044,566 A 4/2000 Ries et al.  
D439,806 S \* 4/2001 Juhlin et al. .... D7/650  
D466,764 S 12/2002 Haythornthwaite et al.  
D498,985 S 11/2004 Kerr et al.  
D500,233 S 12/2004 Overthun

**1 Claim, 4 Drawing Sheets**

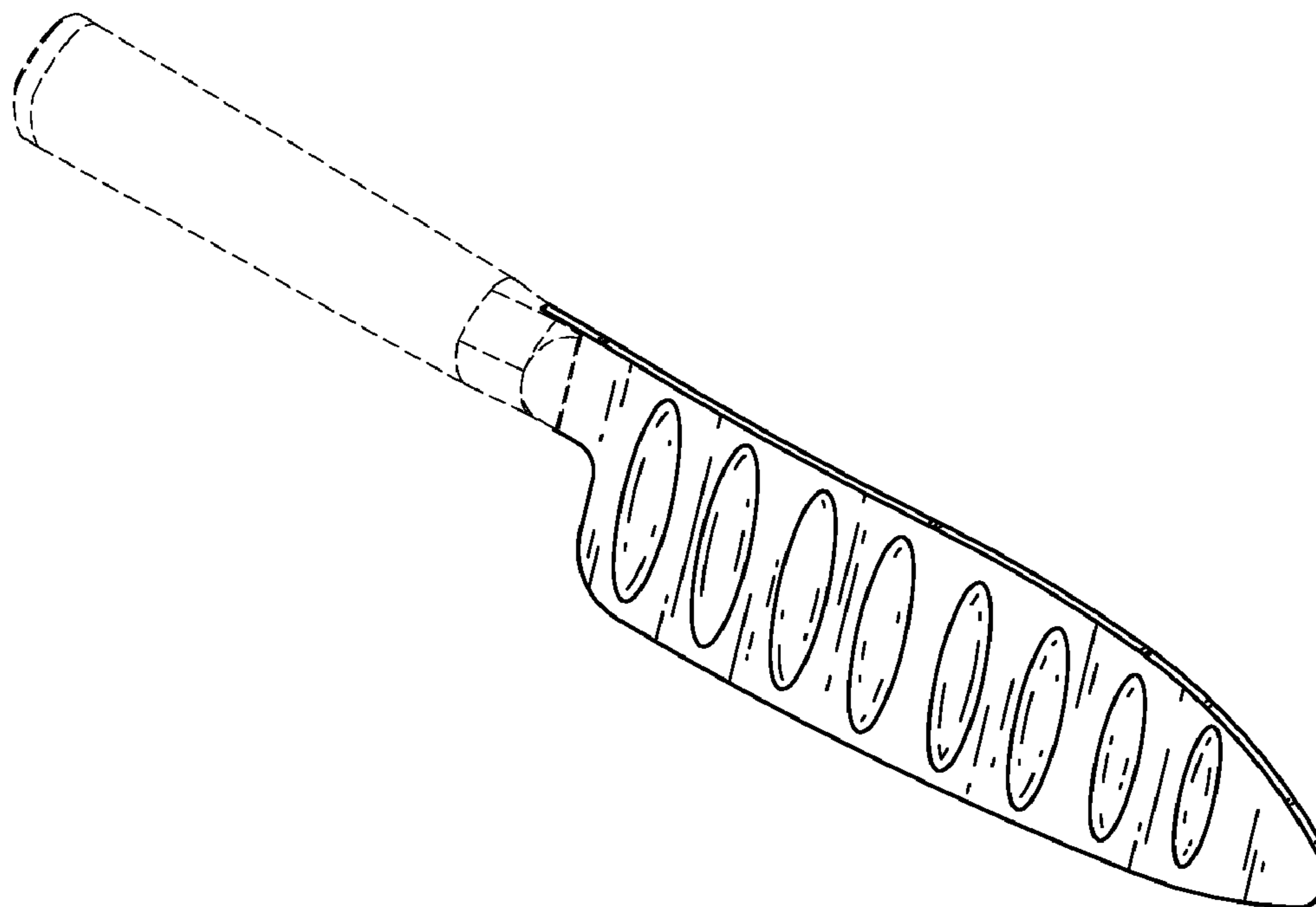

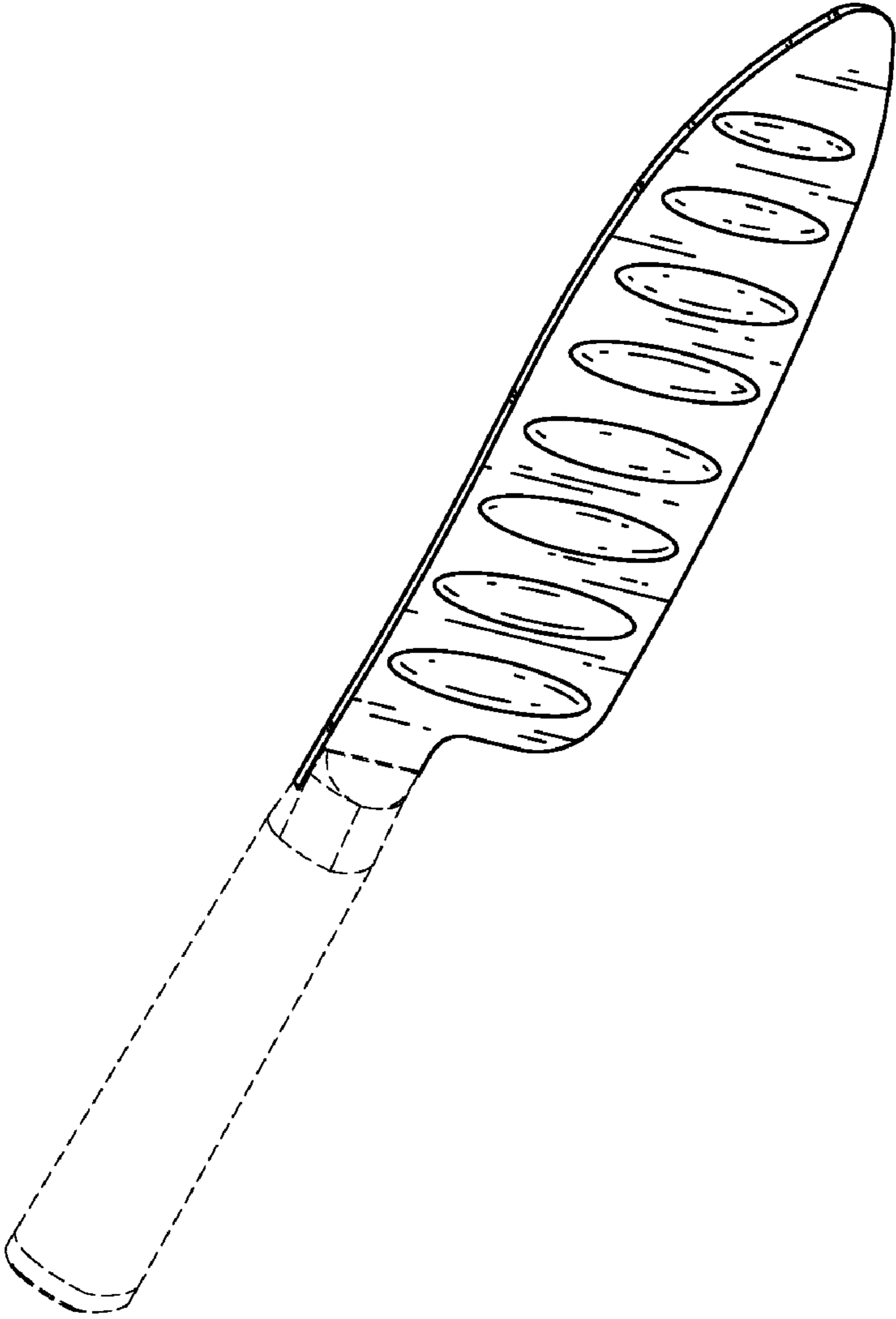

*FIG. 1*

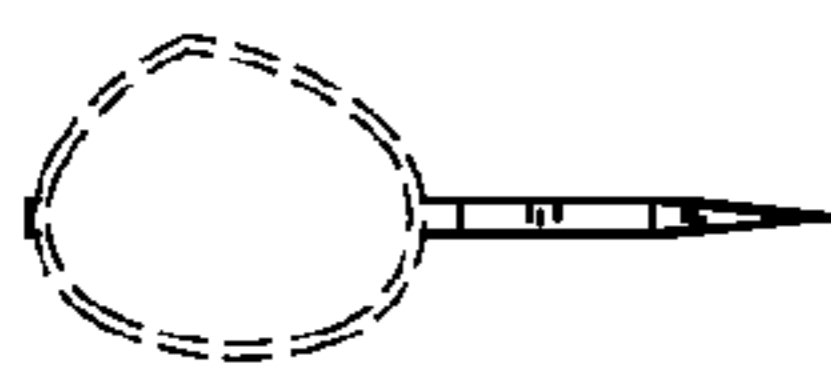

FIG. 2

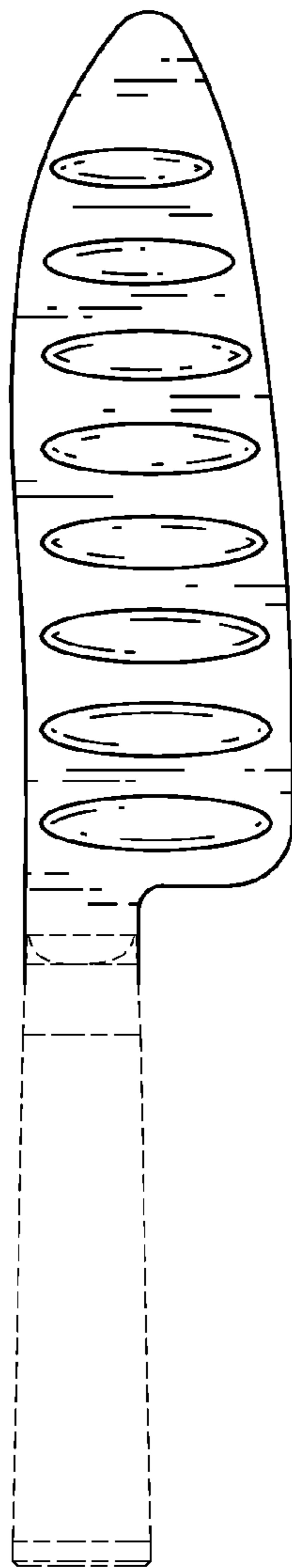

FIG. 3

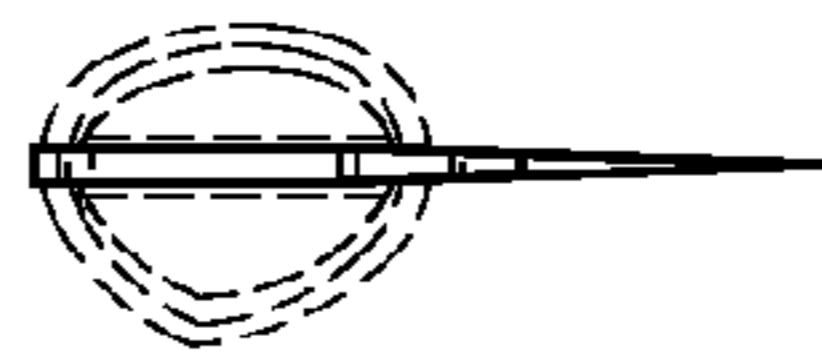
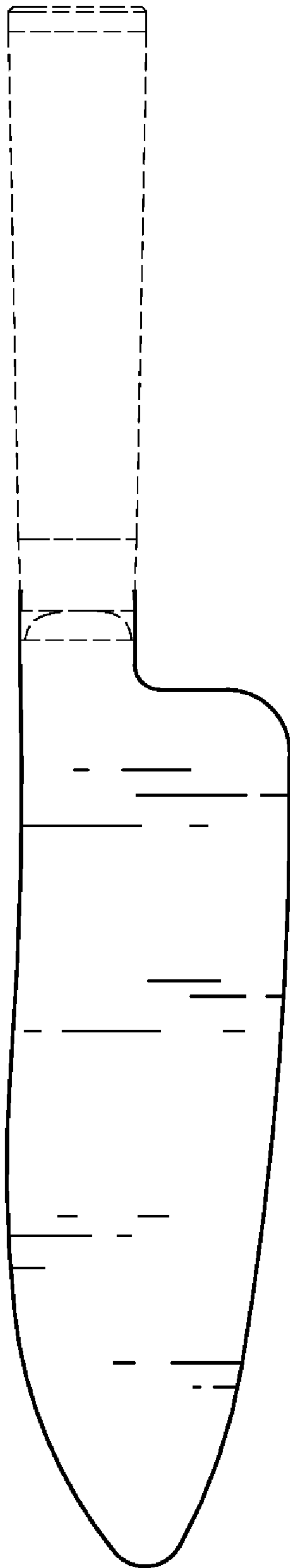
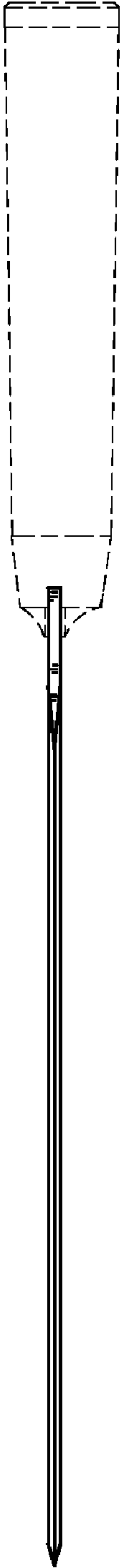

FIG. 4



*FIG. 5*



*FIG. 6*

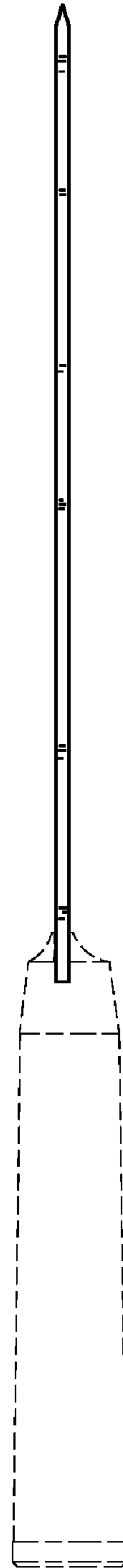

*FIG. 7*