



US00D581693S

(12) **United States Design Patent**  
**Tonella**

(10) **Patent No.:** **US D581,693 S**

(45) **Date of Patent:** **\*\* Dec. 2, 2008**

(54) **DISPLAY PONCHO**

(75) Inventor: **Luca Tonella**, Bienne (CH)

(73) Assignee: **Swatch AG (Swatch SA) (Swatch Ltd.)**,  
Bienne (CH)

(\*\*) Term: **14 Years**

(21) Appl. No.: **29/228,594**

(22) Filed: **Apr. 26, 2005**

(30) **Foreign Application Priority Data**

Jan. 7, 2005 (WO) ..... DM/066 245

(51) **LOC (8) Cl.** ..... **06-07**

(52) **U.S. Cl.** ..... **D6/414**

(58) **Field of Classification Search** ..... D9/414,  
D9/429; D6/468, 396, 441, 414, 449, 472,  
D6/467; 211/59.4, 13.1, 30, 85.3, 85.1, 85.2;  
D25/16

See application file for complete search history.

(56) **References Cited**

**U.S. PATENT DOCUMENTS**

D546,094 S \* 7/2007 Mendini ..... D6/468

\* cited by examiner

*Primary Examiner*—Caron Veynar

*Assistant Examiner*—Sydney R Buffalow

(74) *Attorney, Agent, or Firm*—Collen IP; Donald J. Ranft

(57) **CLAIM**

The ornamental design for a display poncho, as shown and described.

**DESCRIPTION**

FIG. 1 is a front view of my new and ornamental design for a display poncho;

FIG. 2 is a left side view thereof;

FIG. 3 is a rear view thereof;

FIG. 4 is a right side view thereof;

FIG. 5 is a top view thereof;

FIG. 6 is a bottom view thereof; and,

FIG. 7 is a perspective view thereof.

The portions of the display poncho shown in broken lines form no part of the claimed design.

**1 Claim, 4 Drawing Sheets**

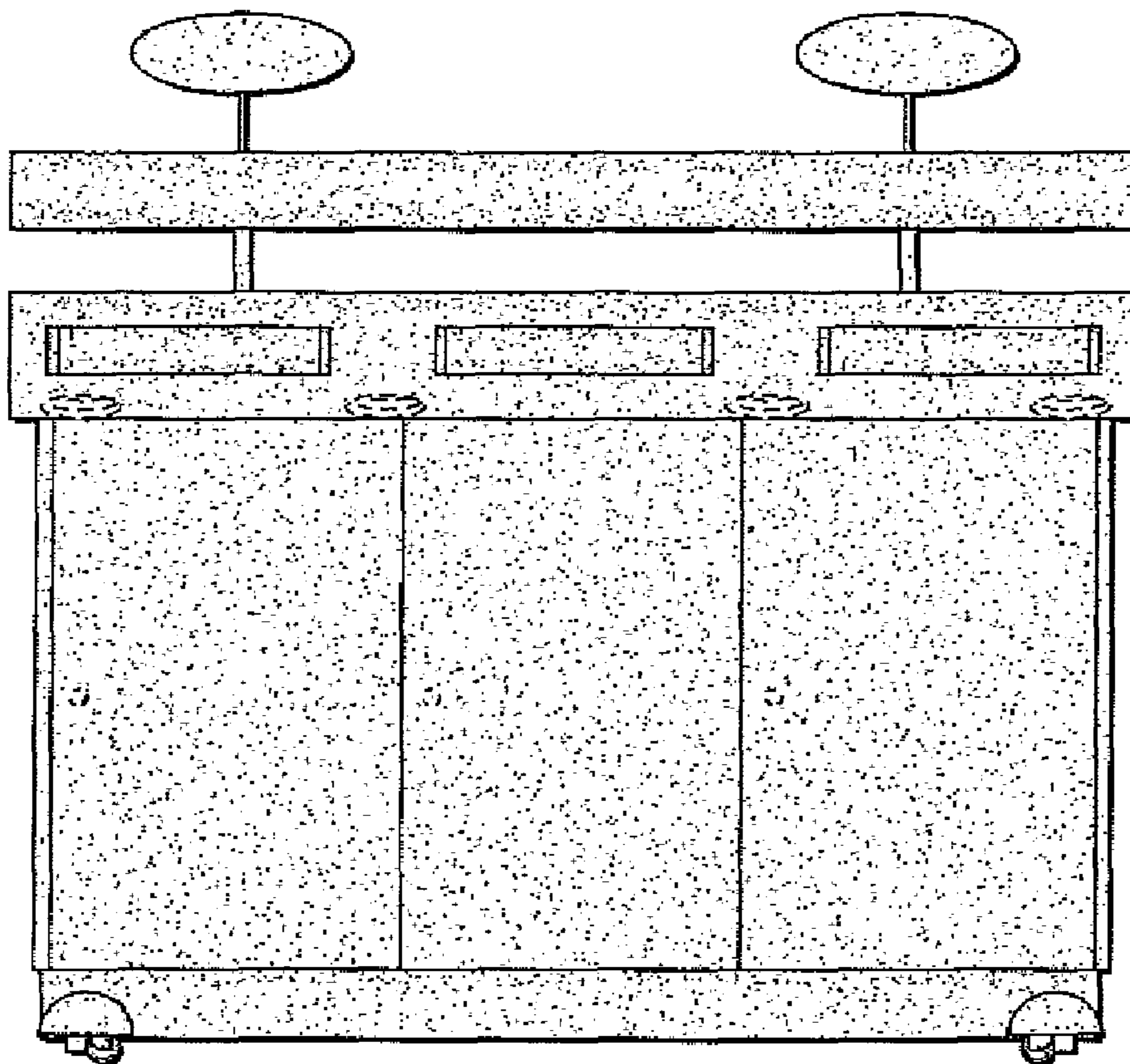

Fig. 1

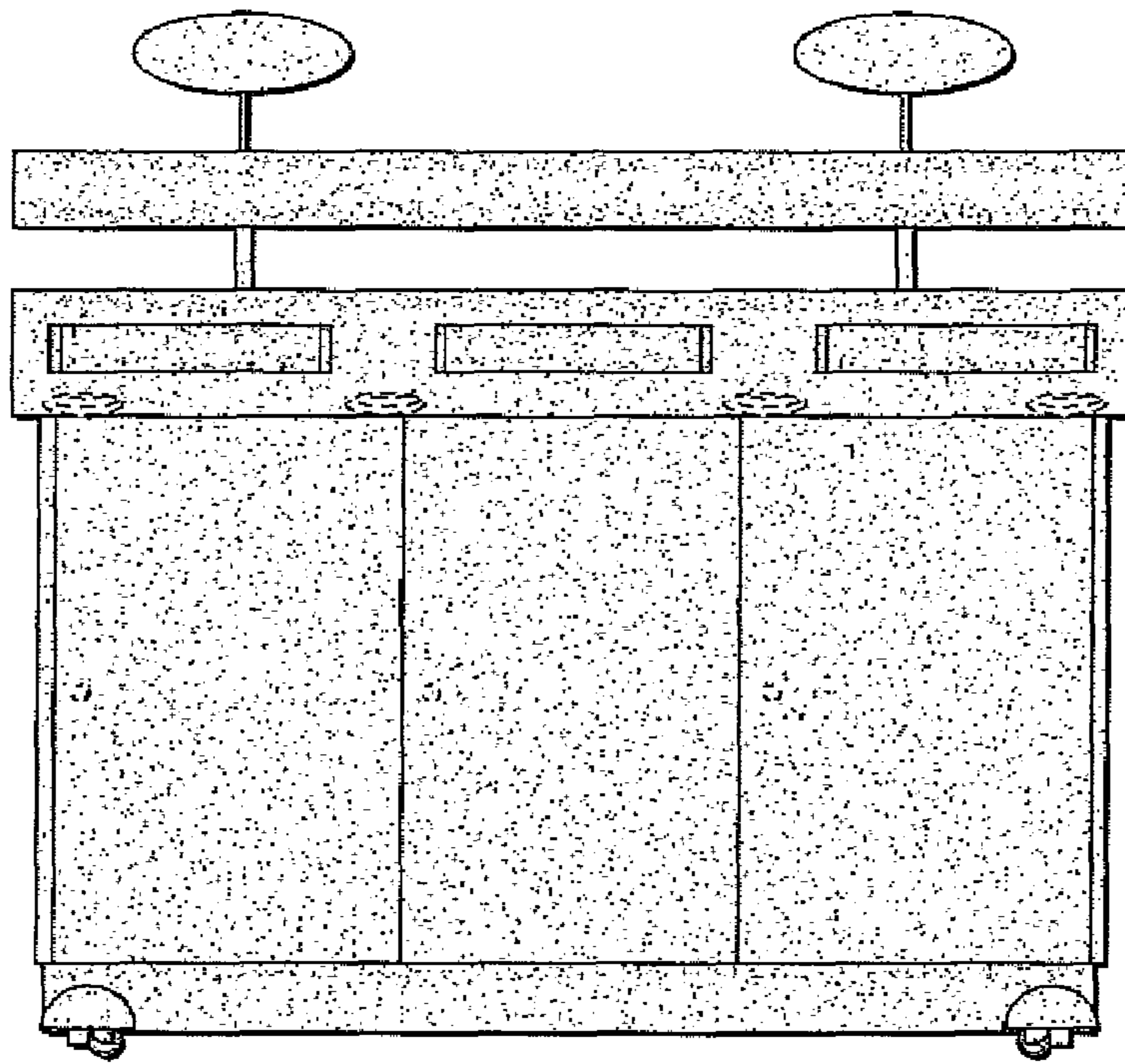

Fig. 2

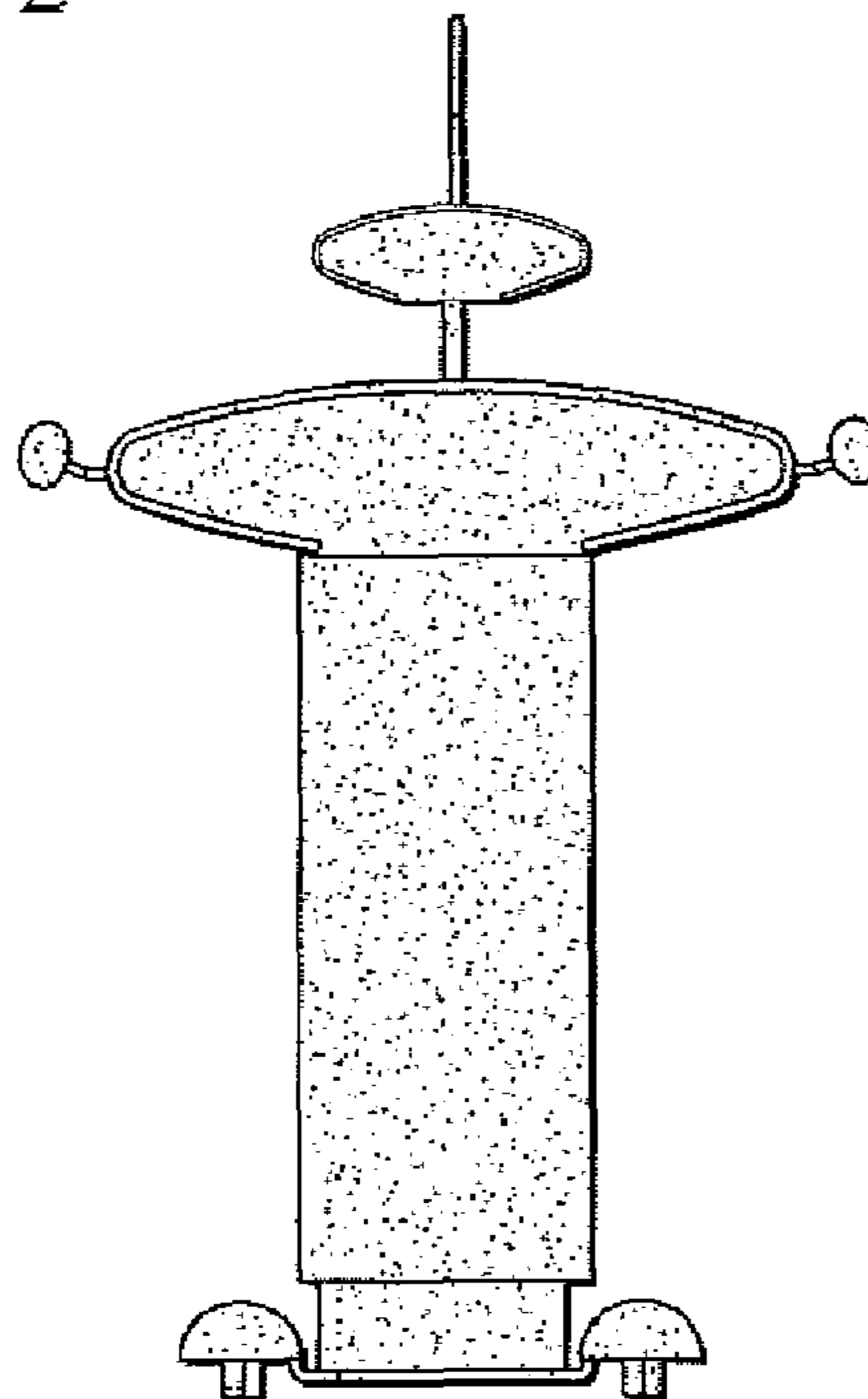

Fig. 3

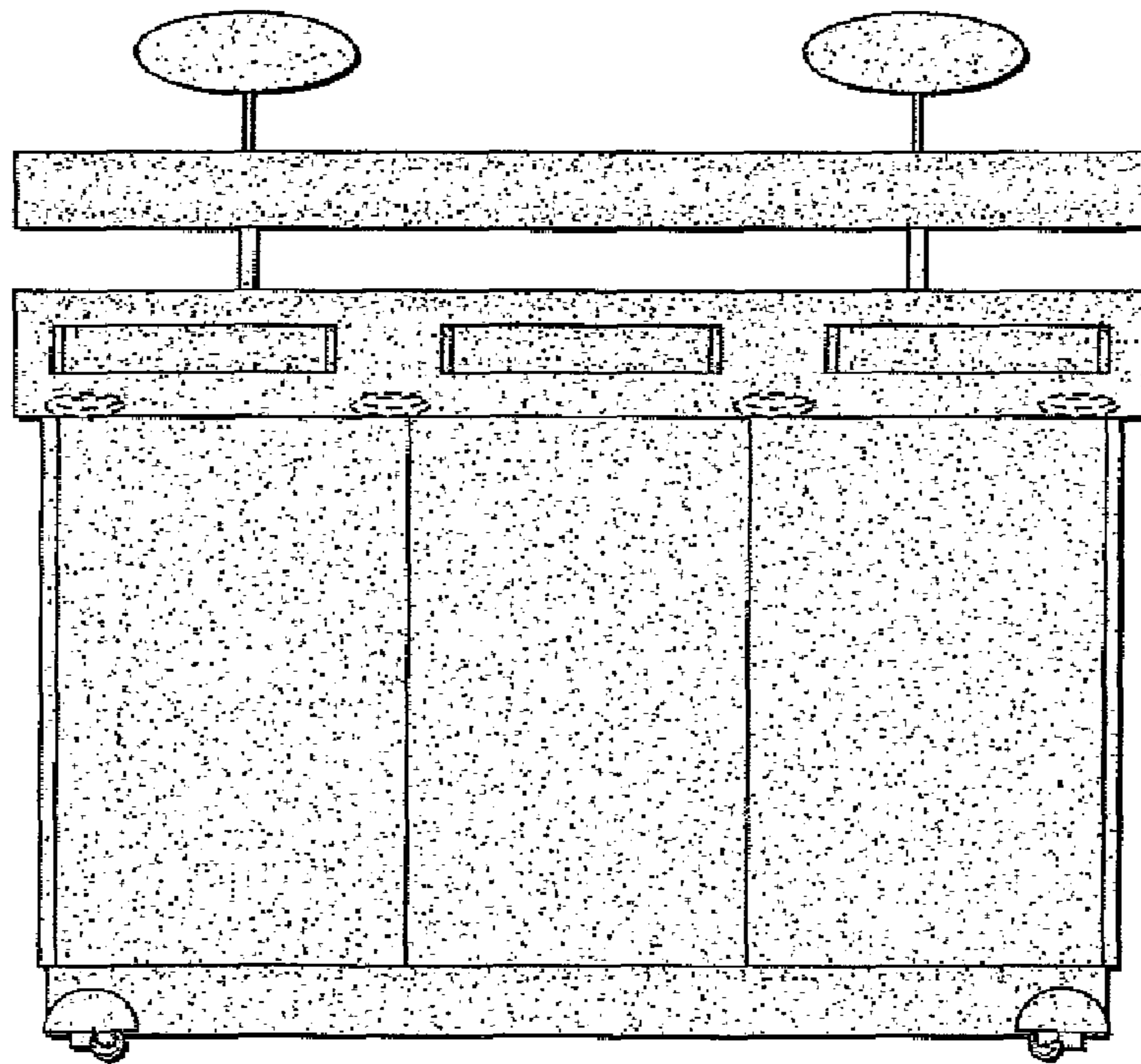

Fig. 4

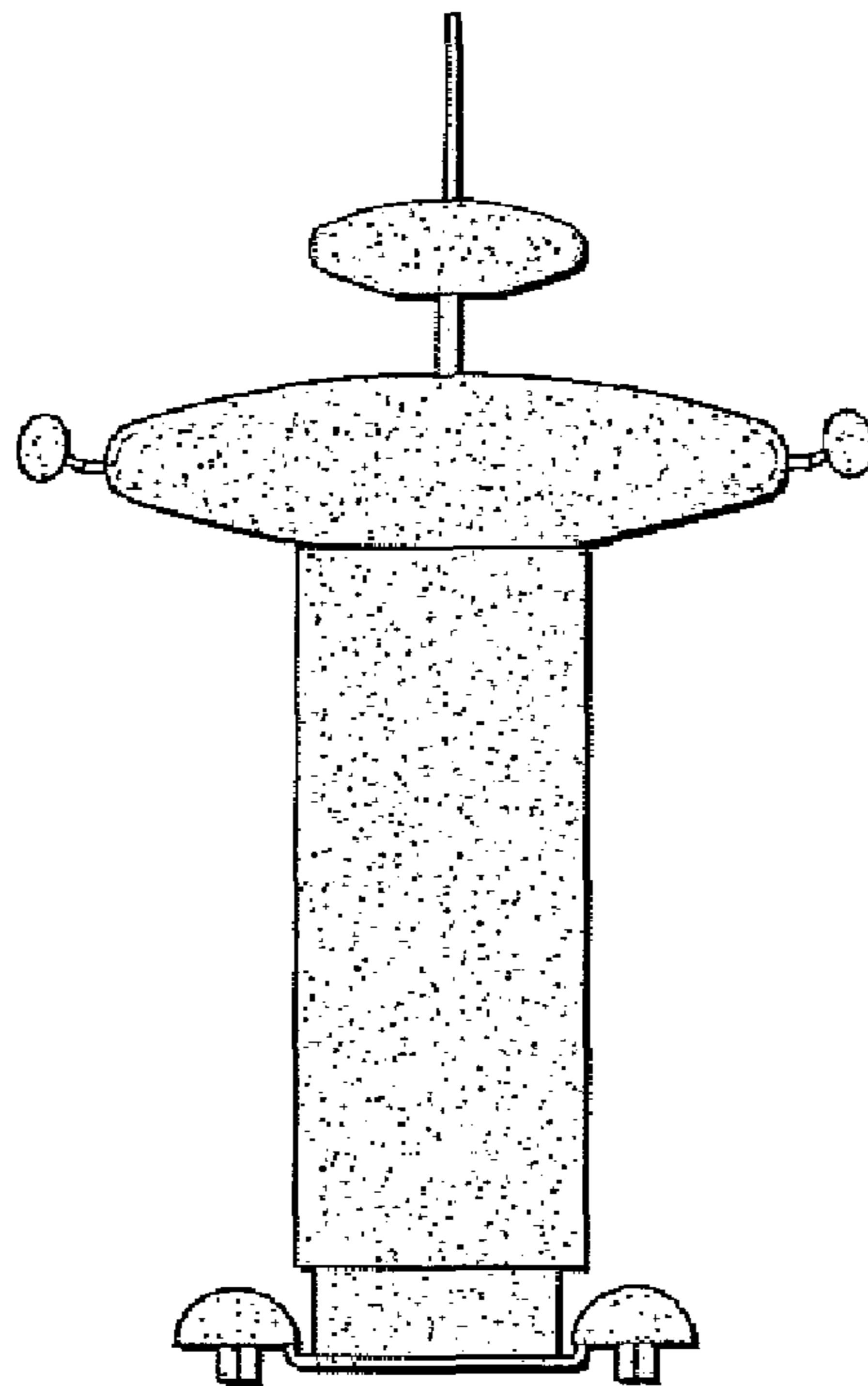



Fig. 5

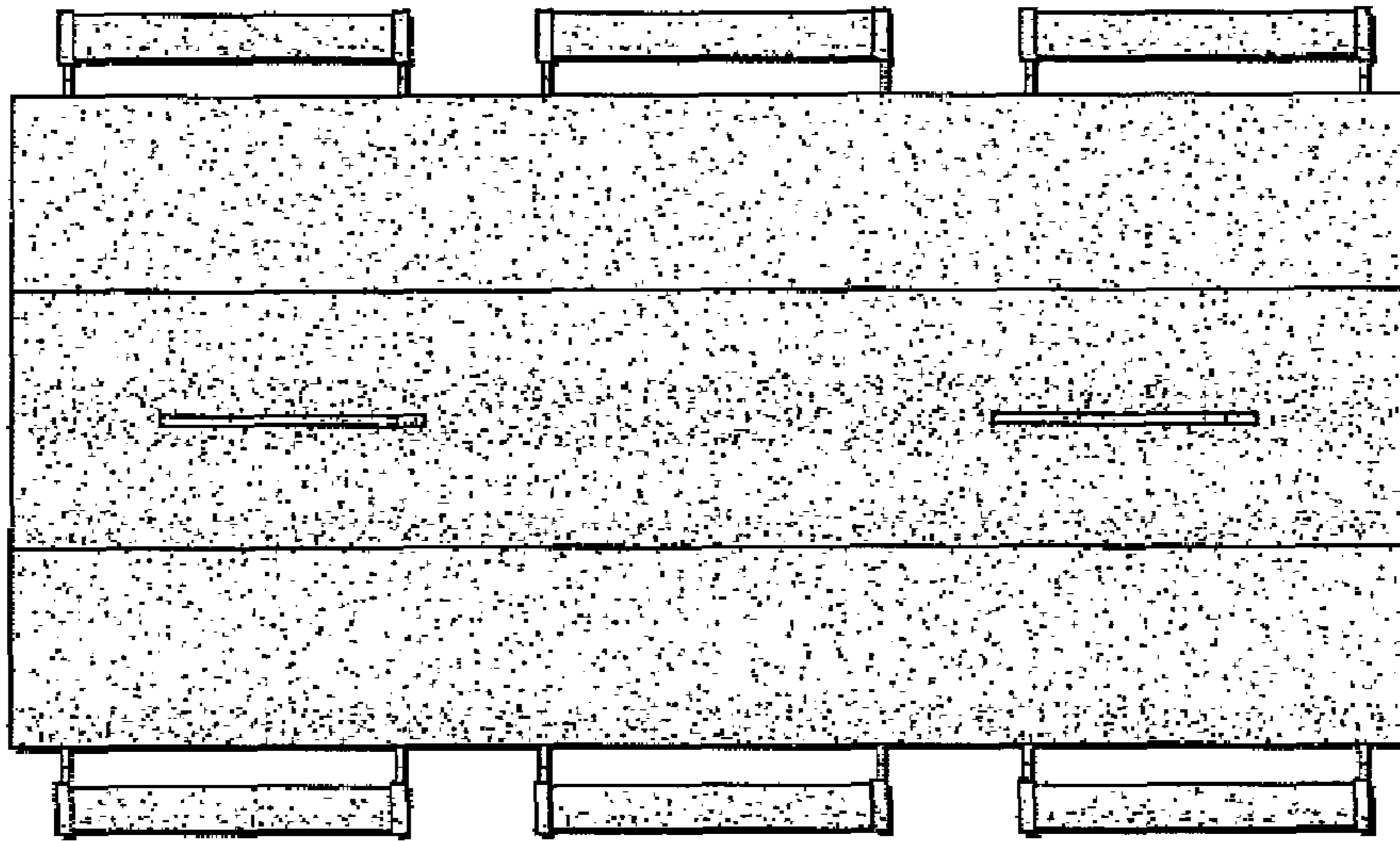

Fig. 6

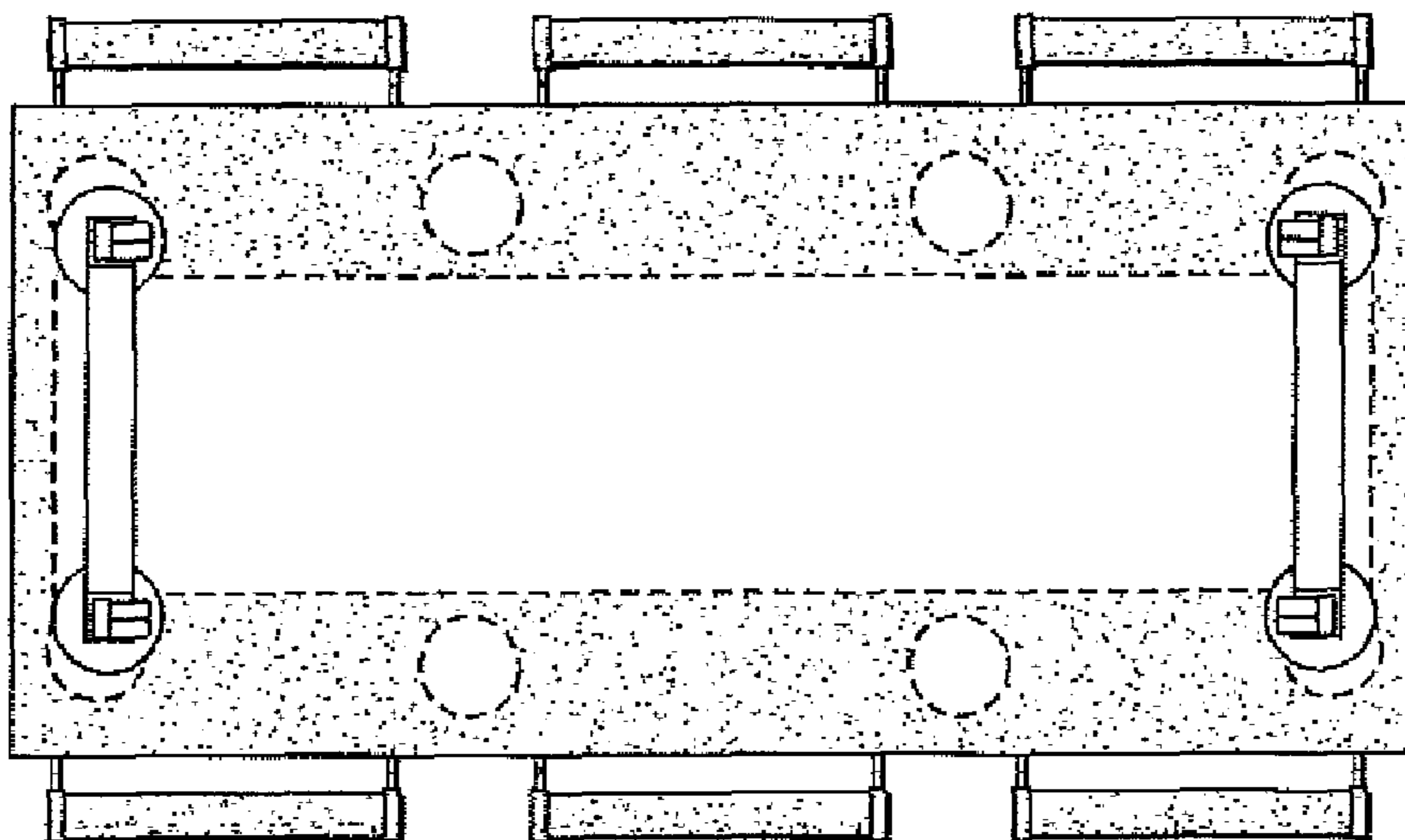

Fig. 7

