



US00D581674S

(12) **United States Design Patent**
Dumler et al.

(10) **Patent No.:** **US D581,674 S**
(45) **Date of Patent:** **** Dec. 2, 2008**

- (54) **MASCARA BRUSH**
- (75) Inventors: **Norbert Dumler**, Ansbach (DE);
Daniela Kulik, Feuchtwangen (DE)
- (73) Assignee: **Geka Brush GmbH**,
Bechhofen-Waizendorf (DE)
- (**) Term: **14 Years**
- (21) Appl. No.: **29/269,763**
- (22) Filed: **Dec. 8, 2006**
- (30) **Foreign Application Priority Data**
Jun. 8, 2006 (EM) 000540869-0009
- (51) **LOC (8) Cl.** **04-02**
- (52) **U.S. Cl.** **D4/128; D4/136**
- (58) **Field of Classification Search** D4/116,
D4/128, 136; D28/7, 35, 36; 15/27, 188;
132/216-218, 223, 226, 237, 262, 271, 317,
132/320
See application file for complete search history.

- (56) **References Cited**
U.S. PATENT DOCUMENTS
4,635,659 A * 1/1987 Spatz 132/218
4,964,429 A * 10/1990 Cole 132/218
5,918,994 A * 7/1999 Gueret 401/122
6,616,366 B1 * 9/2003 Weihrauch 401/286
2005/0046087 A1 * 3/2005 De Laforcade 264/478

2007/0062551 A1* 3/2007 De Brouwer et al. 132/218
FOREIGN PATENT DOCUMENTS
DE 10102219 A1 * 7/2002
OTHER PUBLICATIONS
EU 330436-0021 Industrial Design Application (Coronet-Werke
GMBH) Jun. 14, 2005, [online], [retrieved on Oct. 15, 2007]
Retrieved from the Community Design Database of the Office For
Harmonization in the Internal Market using the Internet: <URL:
http://oami.europa.eu>.*
* cited by examiner

Primary Examiner—Cathron Brooks
Assistant Examiner—Lavone D Tabor
(74) *Attorney, Agent, or Firm*—Browdy and Neimark,
P.L.L.C.

(57) **CLAIM**
The ornamental design for a mascara brush, as shown and
described.

DESCRIPTION
FIG. 1 is a detailed view of the mascara brush, showing our
new design;
FIG. 2 is a top view of the mascara brush;
FIG. 3 is a bottom view of FIG. 2;
FIG. 4 a reduced perspective view of FIG. 2;
FIG. 5 is a right side view of FIG. 2; and,
FIG. 6 is a left side view of FIG. 2.

1 Claim, 2 Drawing Sheets

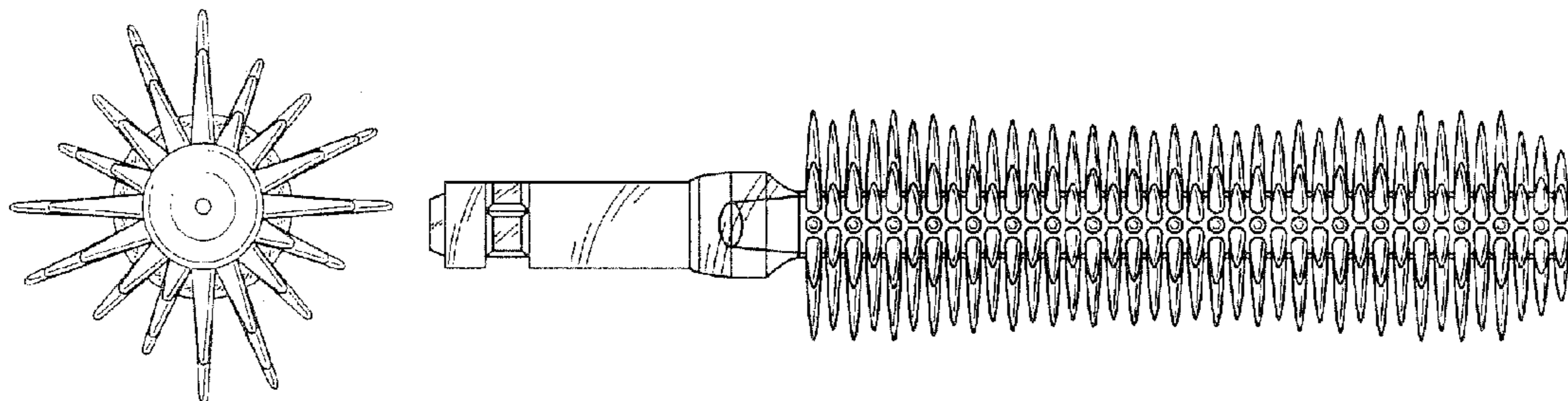

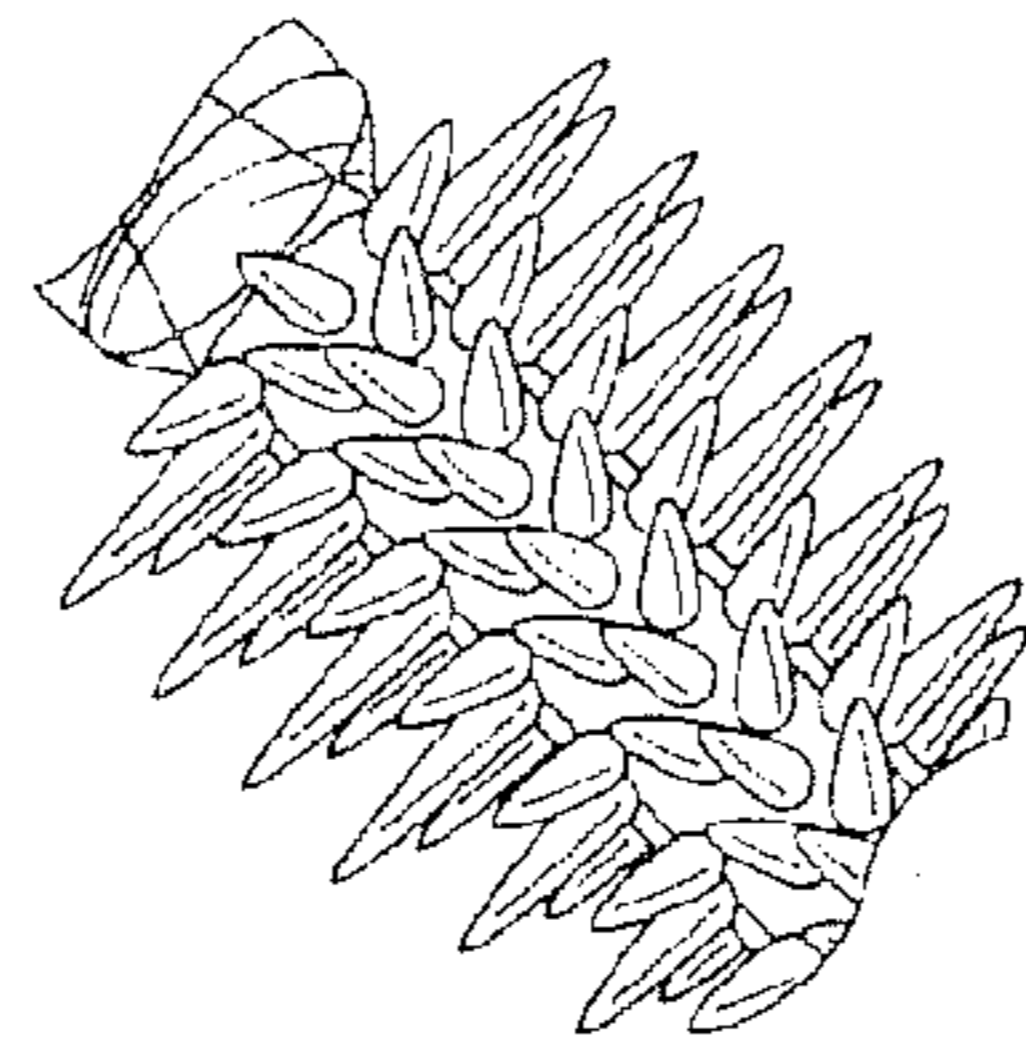

FIG. 1

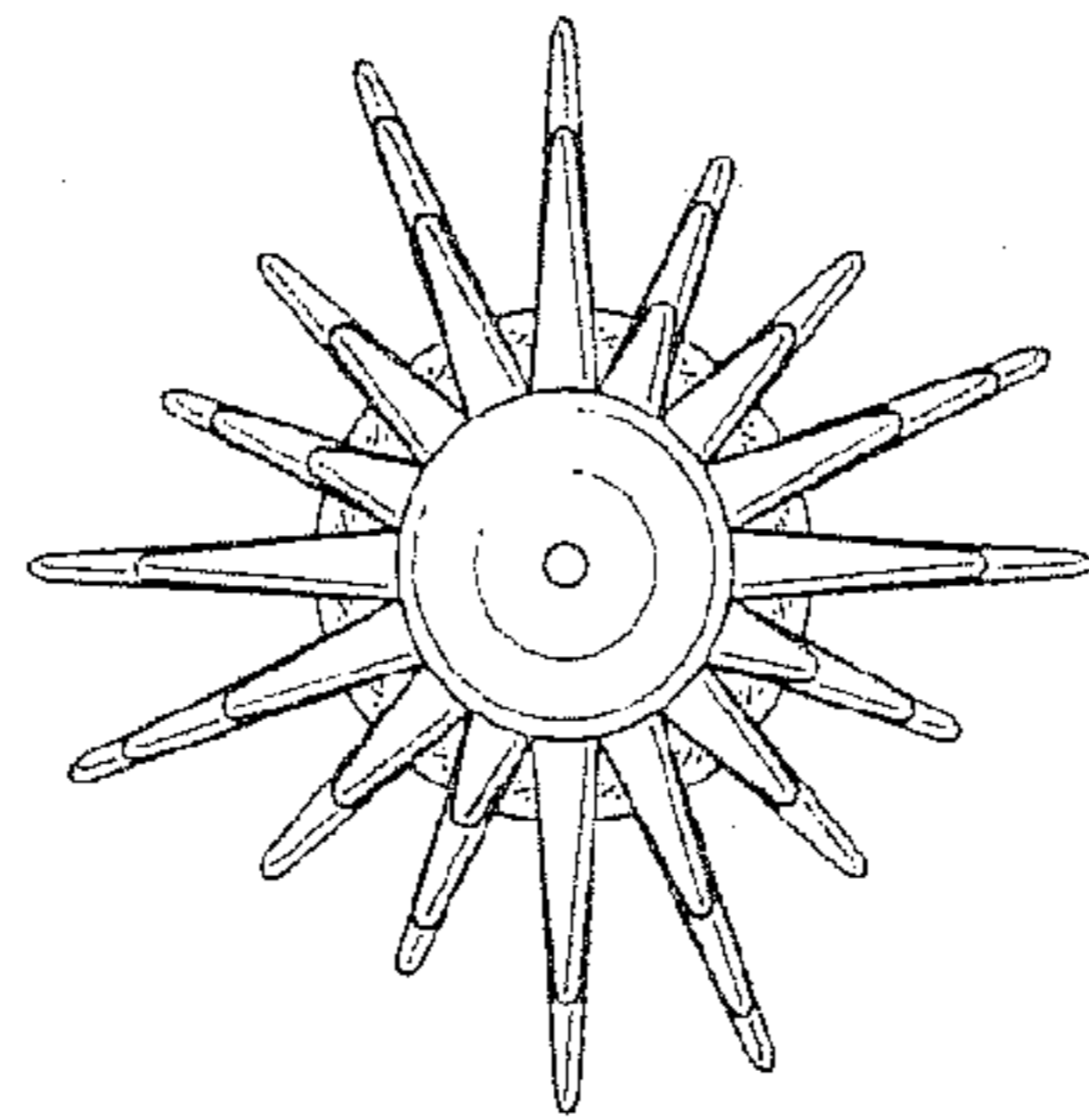

FIG. 2

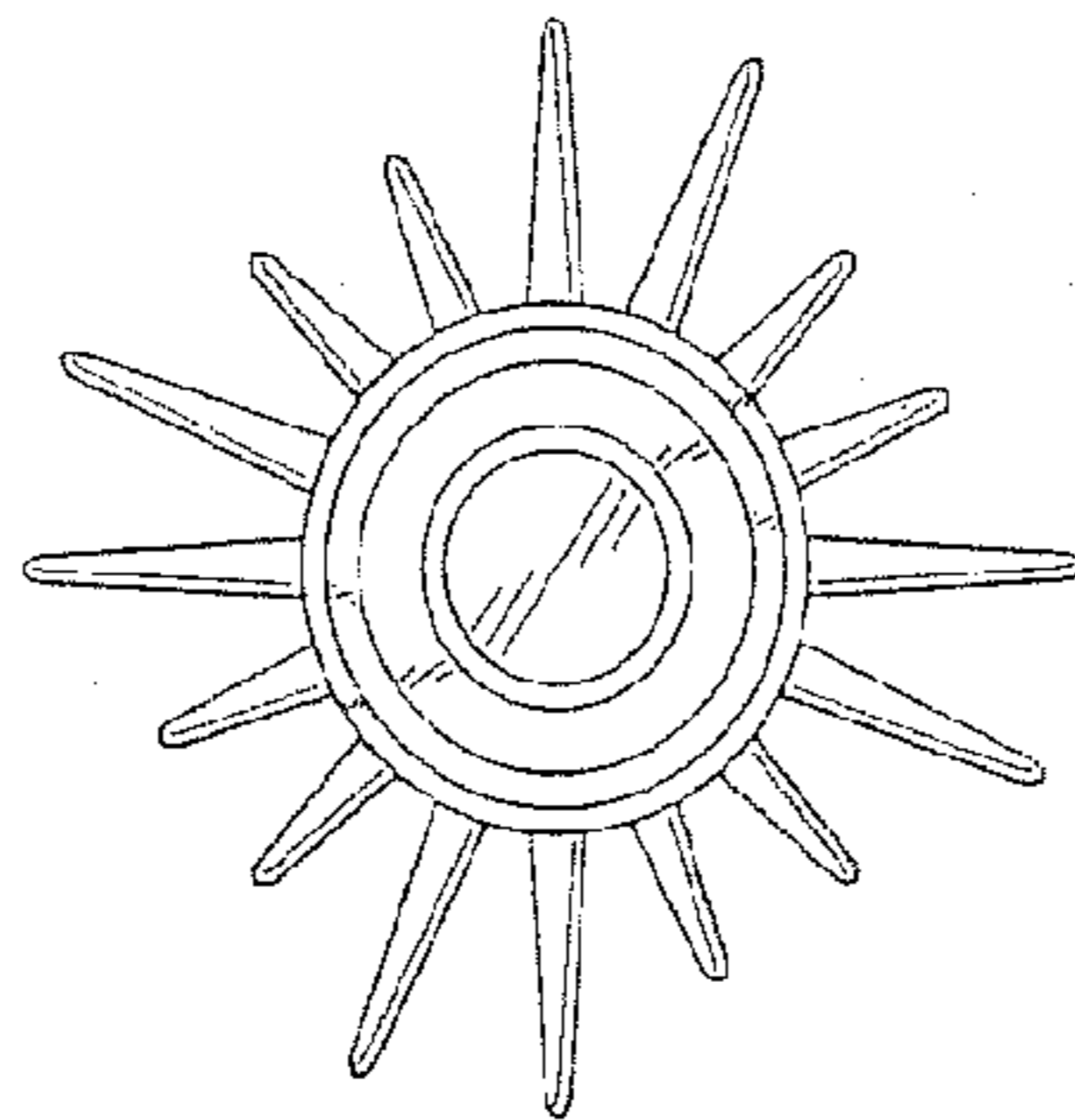

FIG. 3

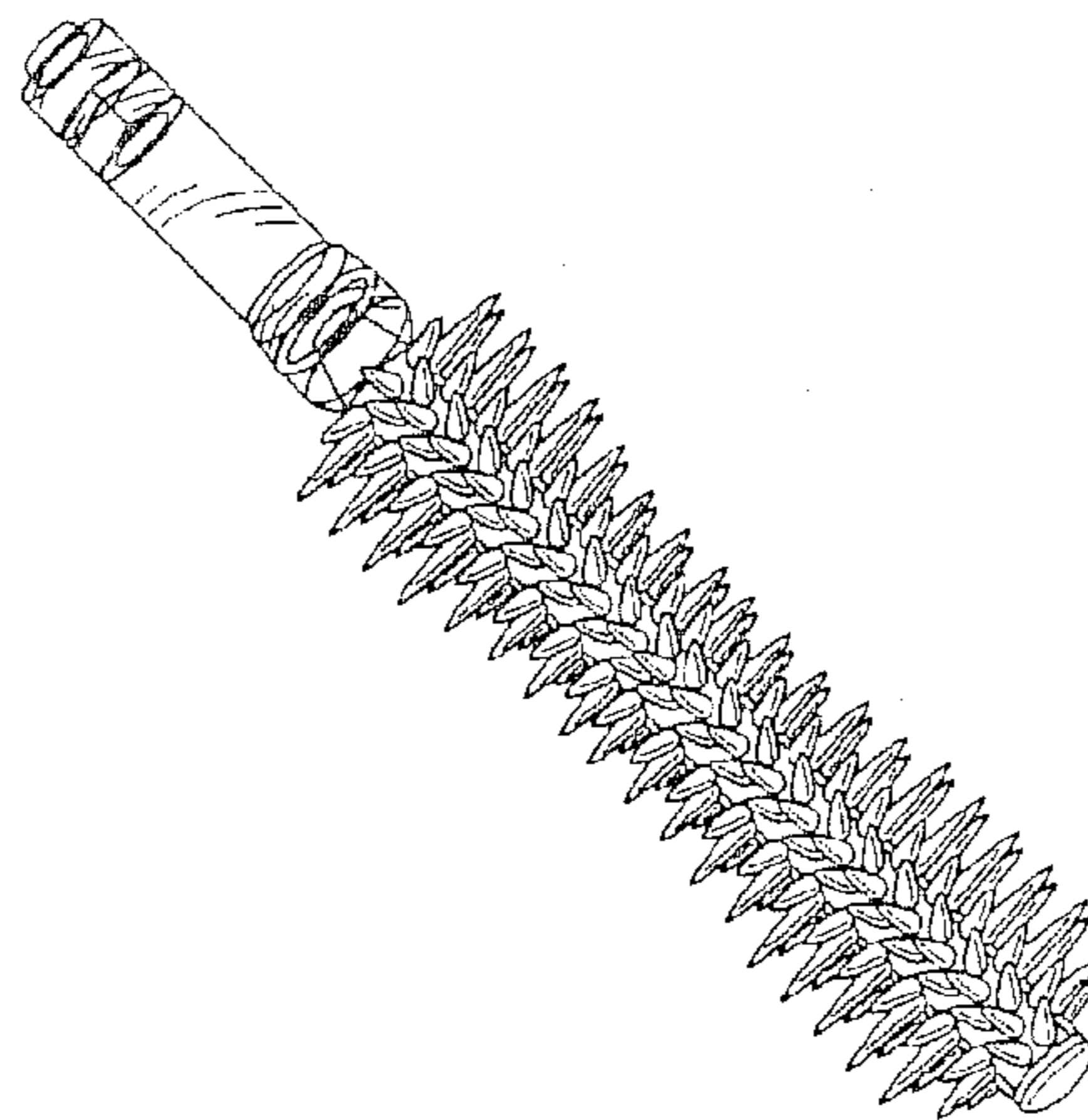

FIG. 4

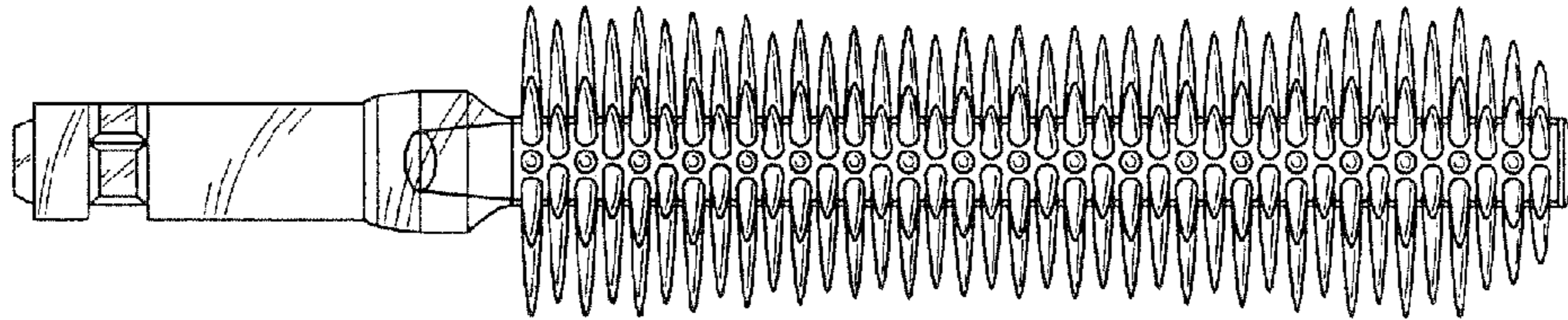

FIG. 5

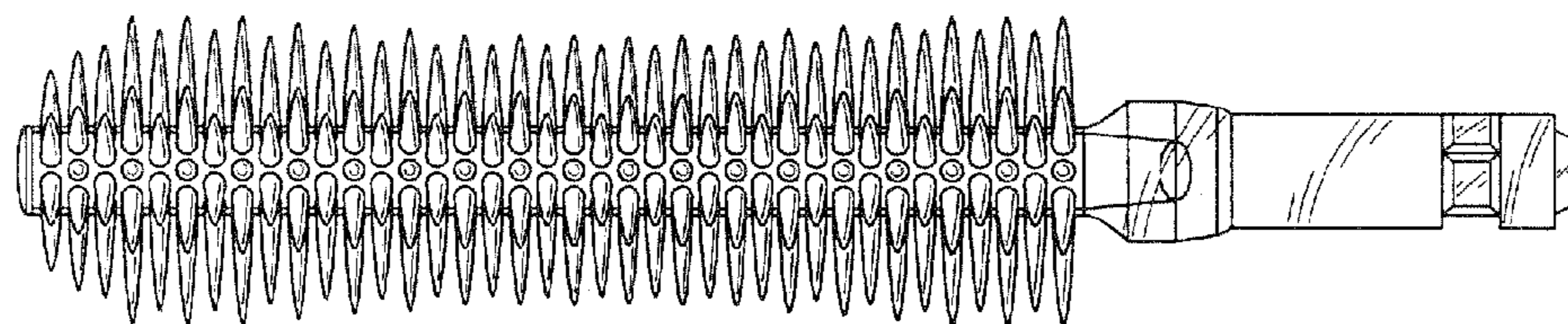

FIG. 6