



US00D581507S

(12) **United States Design Patent**
Schwartz et al.

(10) **Patent No.:** **US D581,507 S**

(45) **Date of Patent:** **** Nov. 25, 2008**

(54) **AIR FRESHENER COMPACT**

(75) Inventors: **Keara Elyse Schwartz**, Cincinnati, OH (US); **Brian Patrick Bjelovuk**, Westerville, OH (US); **Finnegan O’Jennings McKenty**, Cincinnati, OH (US); **Michael Thomas Roller**, Covington, KY (US)

(73) Assignee: **The Procter & Gamble Company**, Cincinnati, OH (US)

(**) Term: **14 Years**

(21) Appl. No.: **29/306,676**

(22) Filed: **Apr. 14, 2008**

(51) **LOC (8) Cl.** **28-99**

(52) **U.S. Cl.** **D23/366**

(58) **Field of Classification Search** D23/355-396;
261/DIG. 17, DIG. 43, DIG. 65, DIG. 88,
261/DIG. 89; 239/34, 35, 53, 56, 57, 60,
239/136, 326; 392/386, 394, 395; D28/5,
D28/6

See application file for complete search history.

(56) **References Cited**

U.S. PATENT DOCUMENTS

D252,706 S	*	8/1979	Schimanski	D23/369
D395,494 S	*	6/1998	Becker	D23/369
D399,945 S		10/1998	Bonomo et al.		
D427,301 S	*	6/2000	Sato et al.	D23/364
D447,551 S	*	9/2001	A’Court	D23/366
D516,193 S	*	2/2006	Caserta et al.	D23/366
D532,506 S	*	11/2006	Caserta et al.	D23/366
D544,953 S	*	6/2007	Kee	D23/368
D553,729 S	*	10/2007	Bayly et al.	D23/366

* cited by examiner

Primary Examiner—Sandra Snapp

(74) *Attorney, Agent, or Firm*—Amy I. Ahn-Roll

(57) **CLAIM**

The ornamental design for an air freshener compact, as shown and described.

DESCRIPTION

FIG. 1 is a perspective view of one embodiment of an air freshener compact, according to the present invention;

FIG. 2 is a top plan view thereof;

FIG. 3 is a bottom plan view thereof;

FIG. 4 is a left side elevational view thereof;

FIG. 5 is a right side elevational view thereof;

FIG. 6 is a rear elevational view thereof;

FIG. 7 is a front elevational view thereof;

FIG. 8 is a top plan view of the air freshener compact in an open configuration, showing a part of the interior;

FIG. 9 is a perspective view of a second embodiment of an air freshener compact according to the present invention;

FIG. 10 is a top plan view thereof;

FIG. 11 is a bottom plan view thereof;

FIG. 12 is a left side elevational view thereof;

FIG. 13 is a right side elevational view thereof;

FIG. 14 is a rear elevational view thereof; and,

FIG. 15 is a front elevational view thereof.

The broken lines shown in the drawings are for illustrative purposes only and form no part of the claimed design.

1 Claim, 7 Drawing Sheets

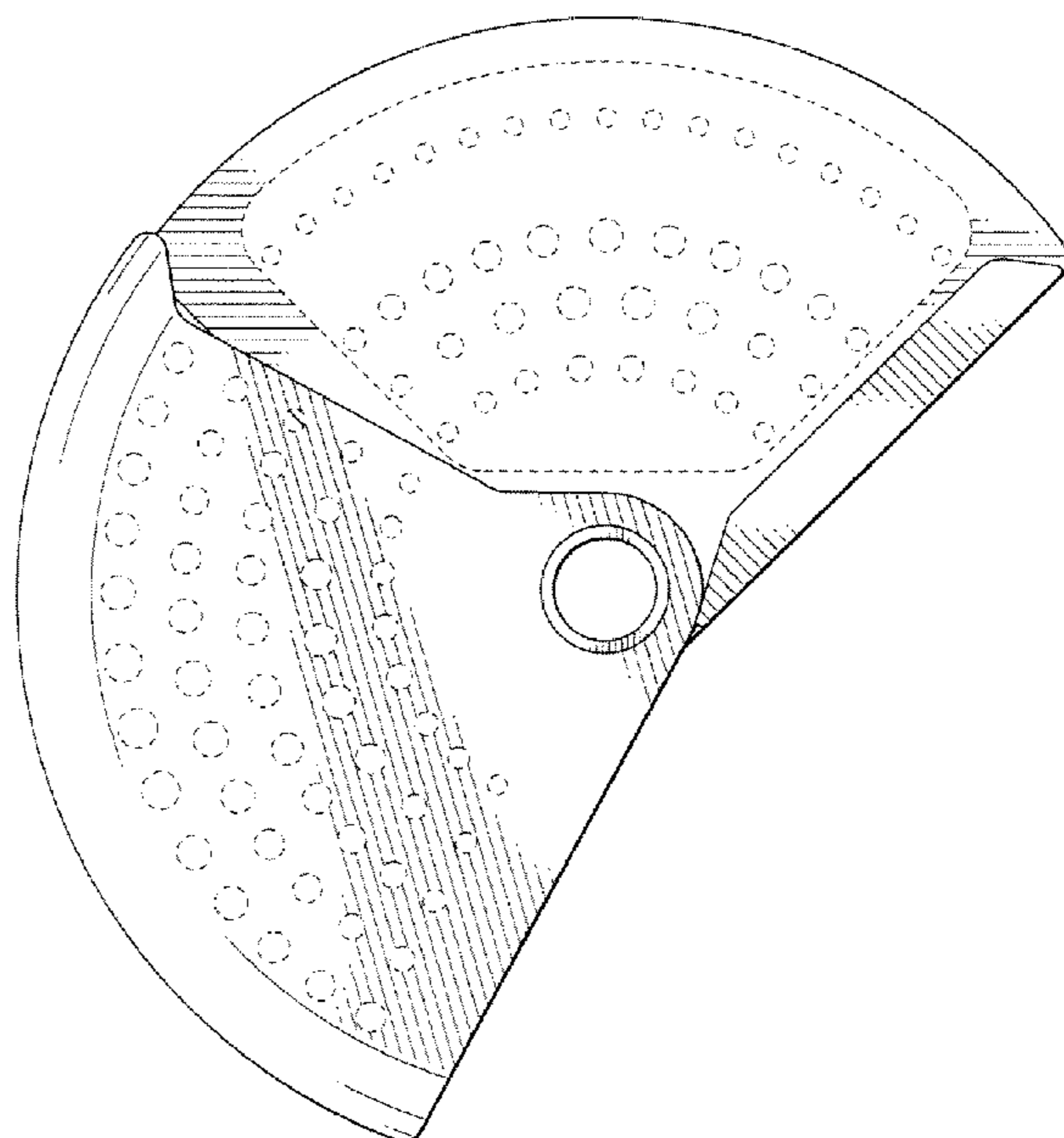
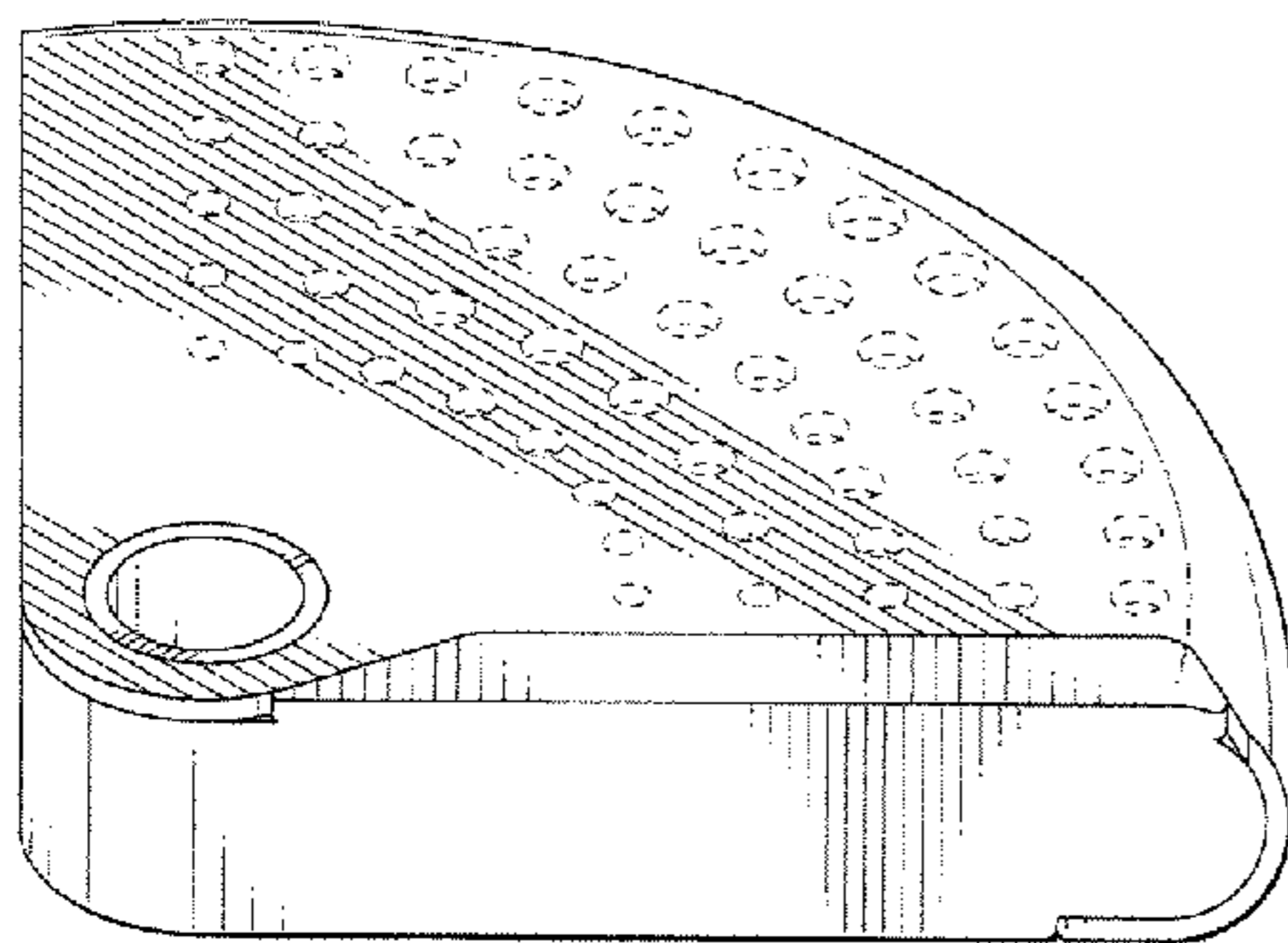

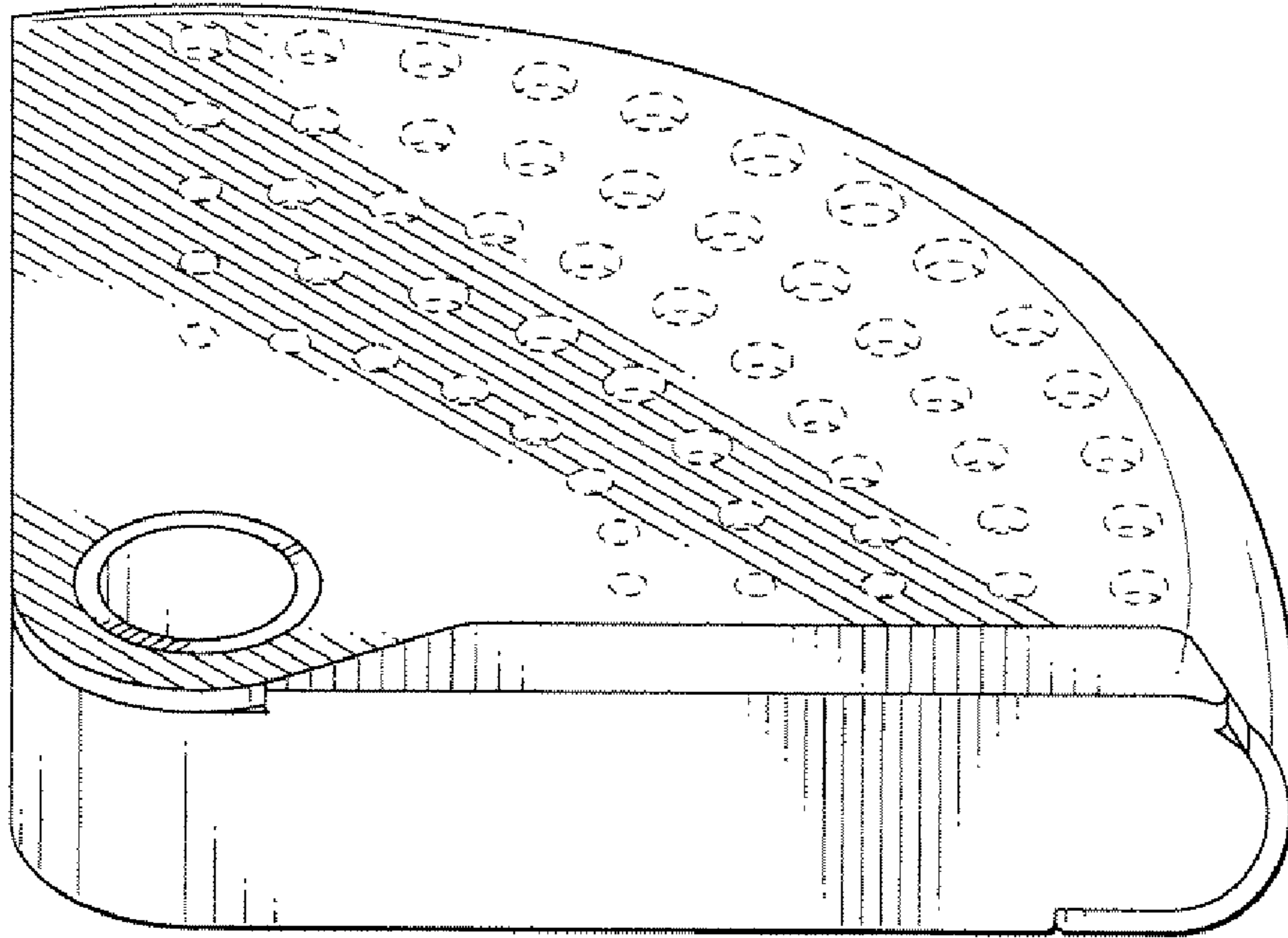

FIG. 1

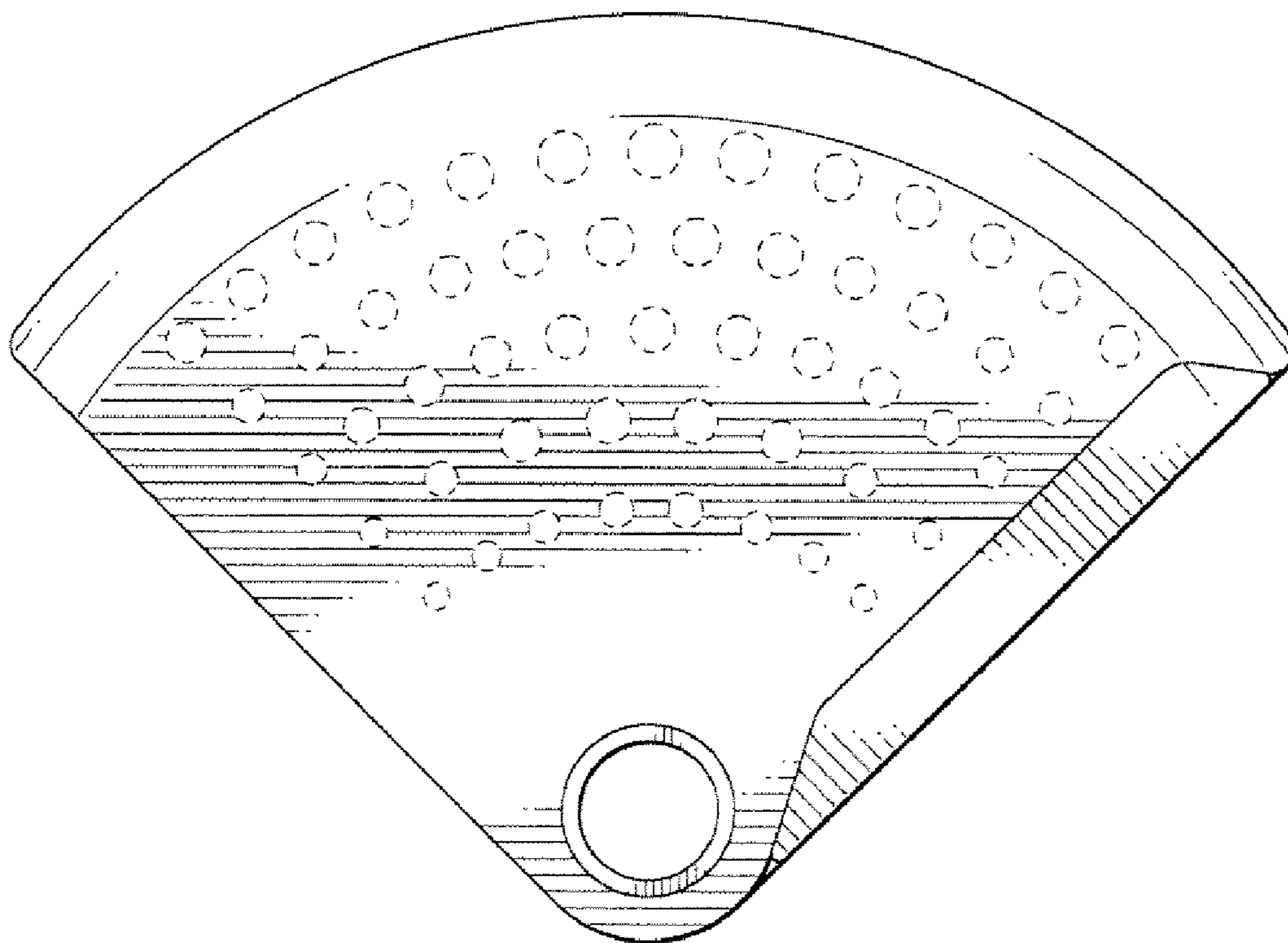

FIG. 2

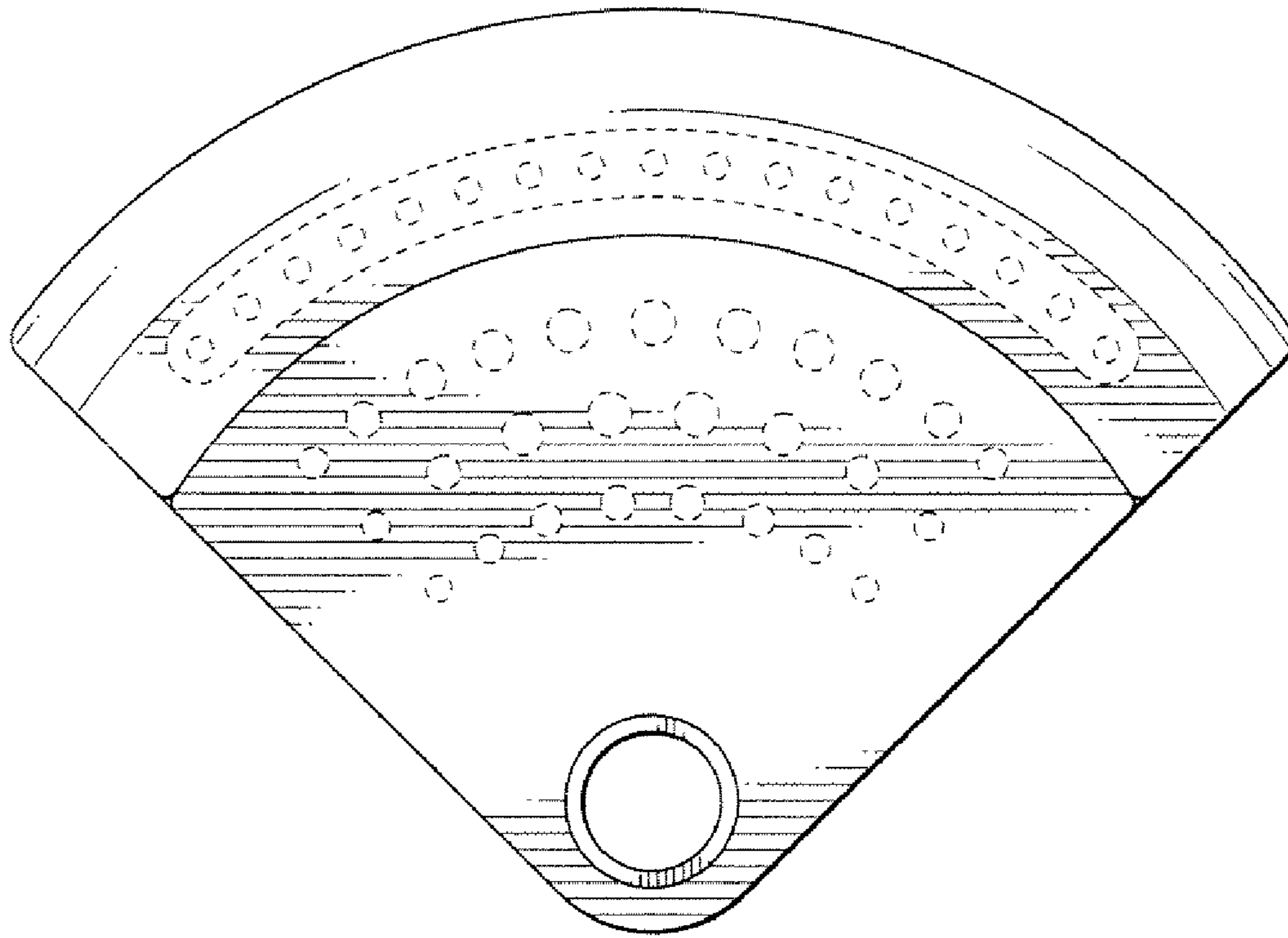

FIG. 3

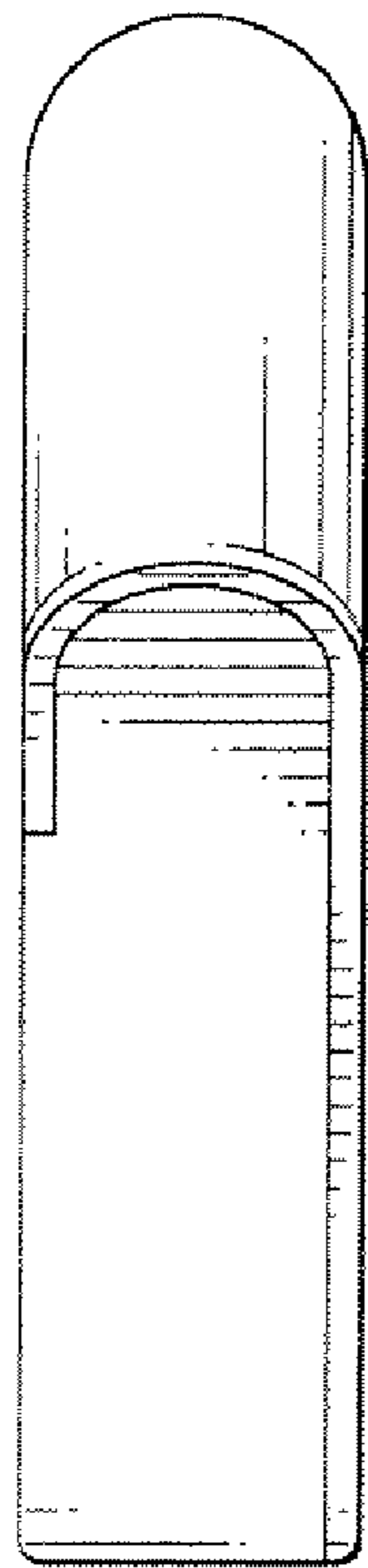

FIG. 4

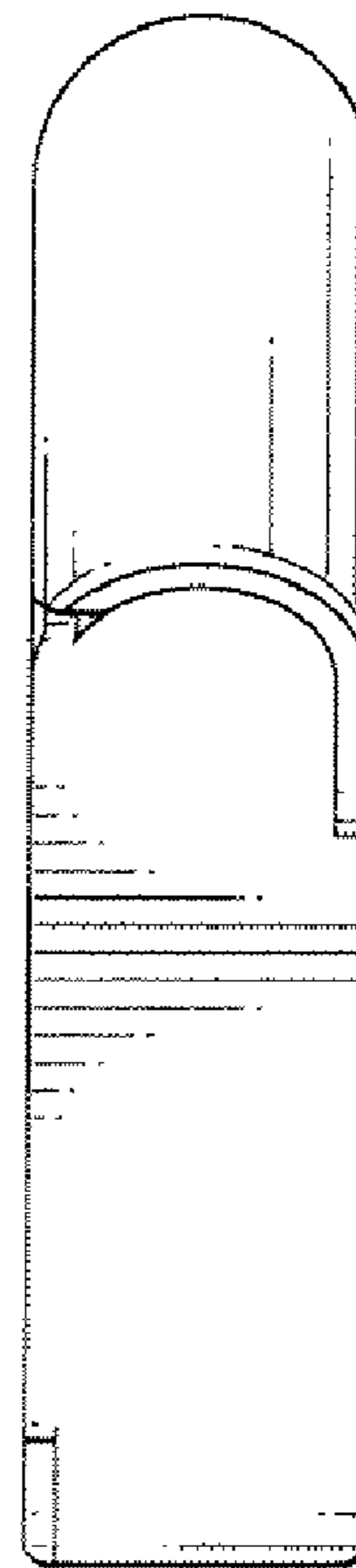

FIG. 5



FIG. 6

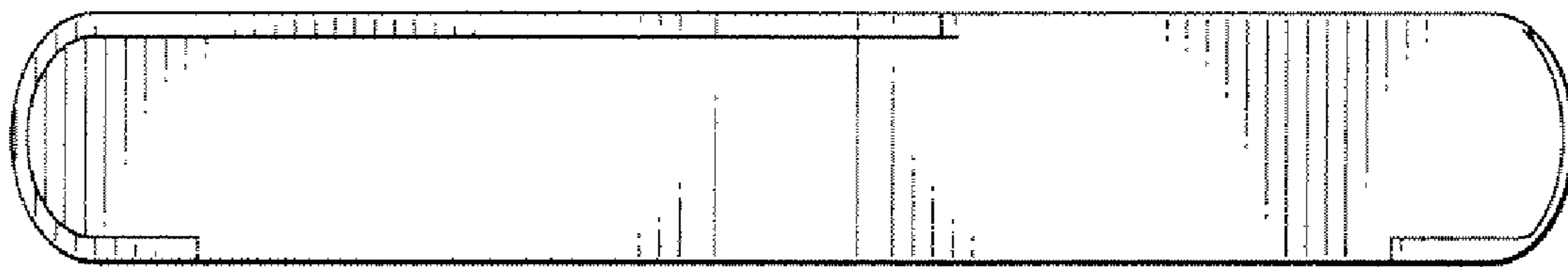

FIG. 7

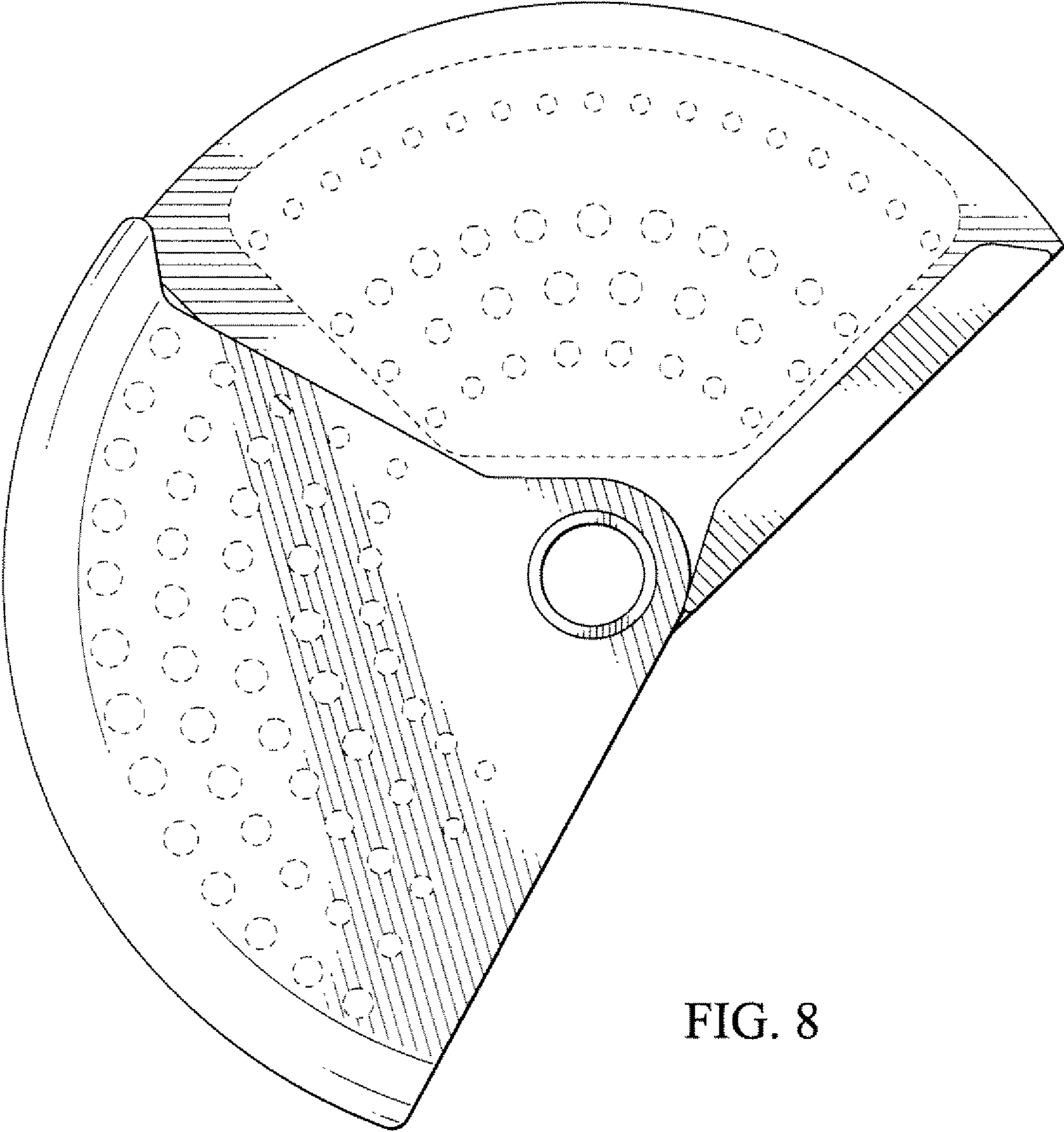

FIG. 8

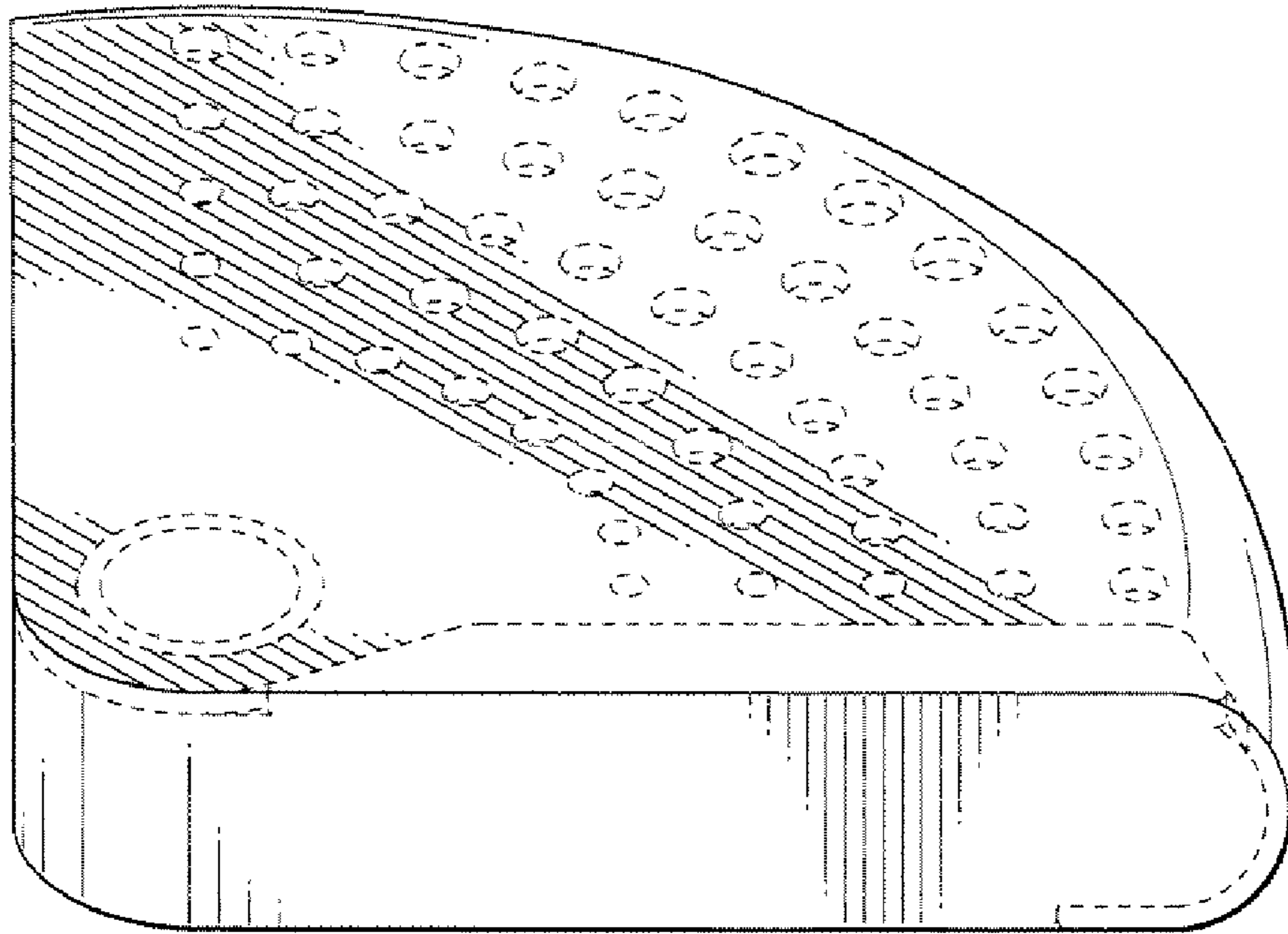

FIG. 9

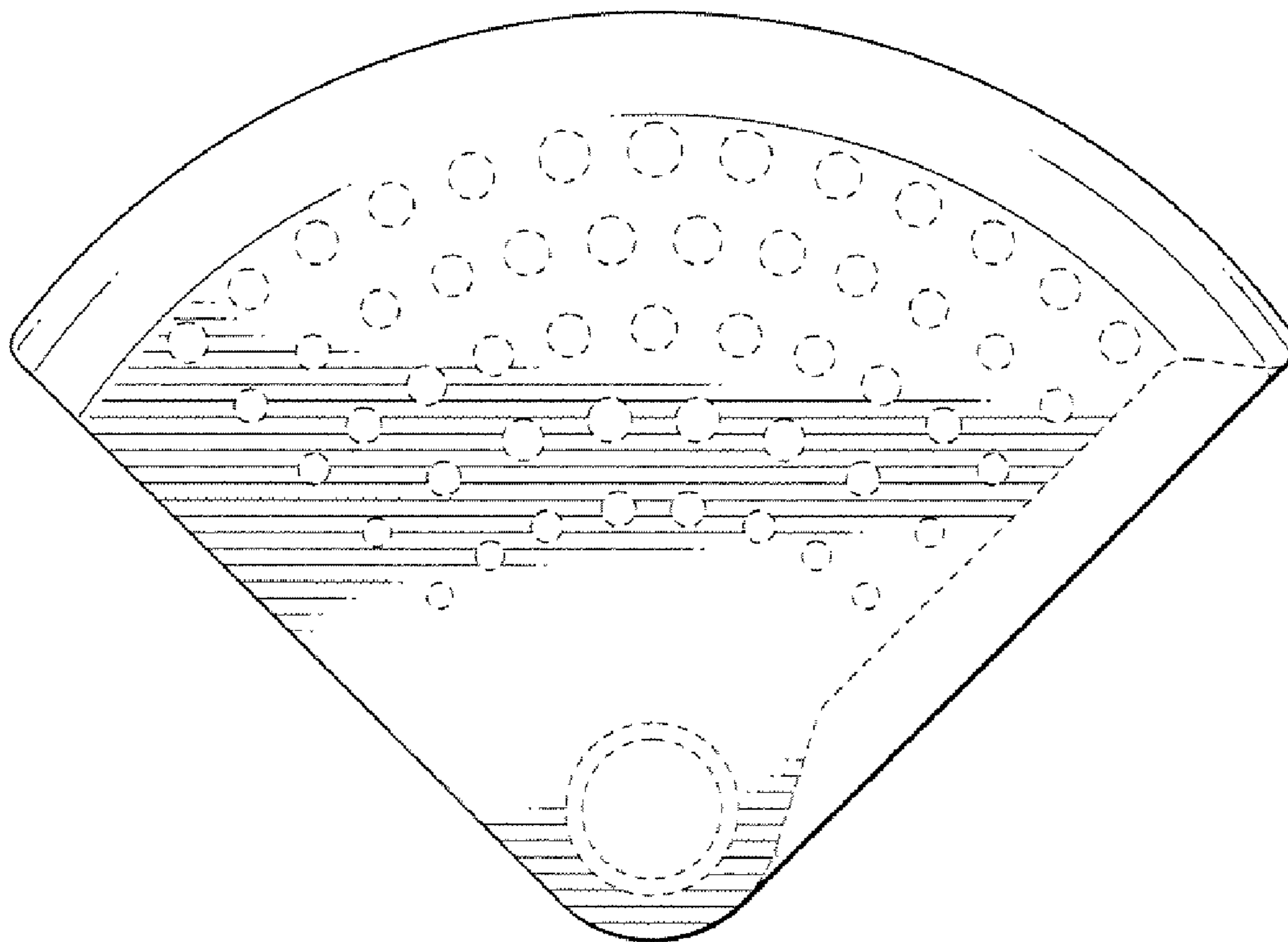

FIG. 10

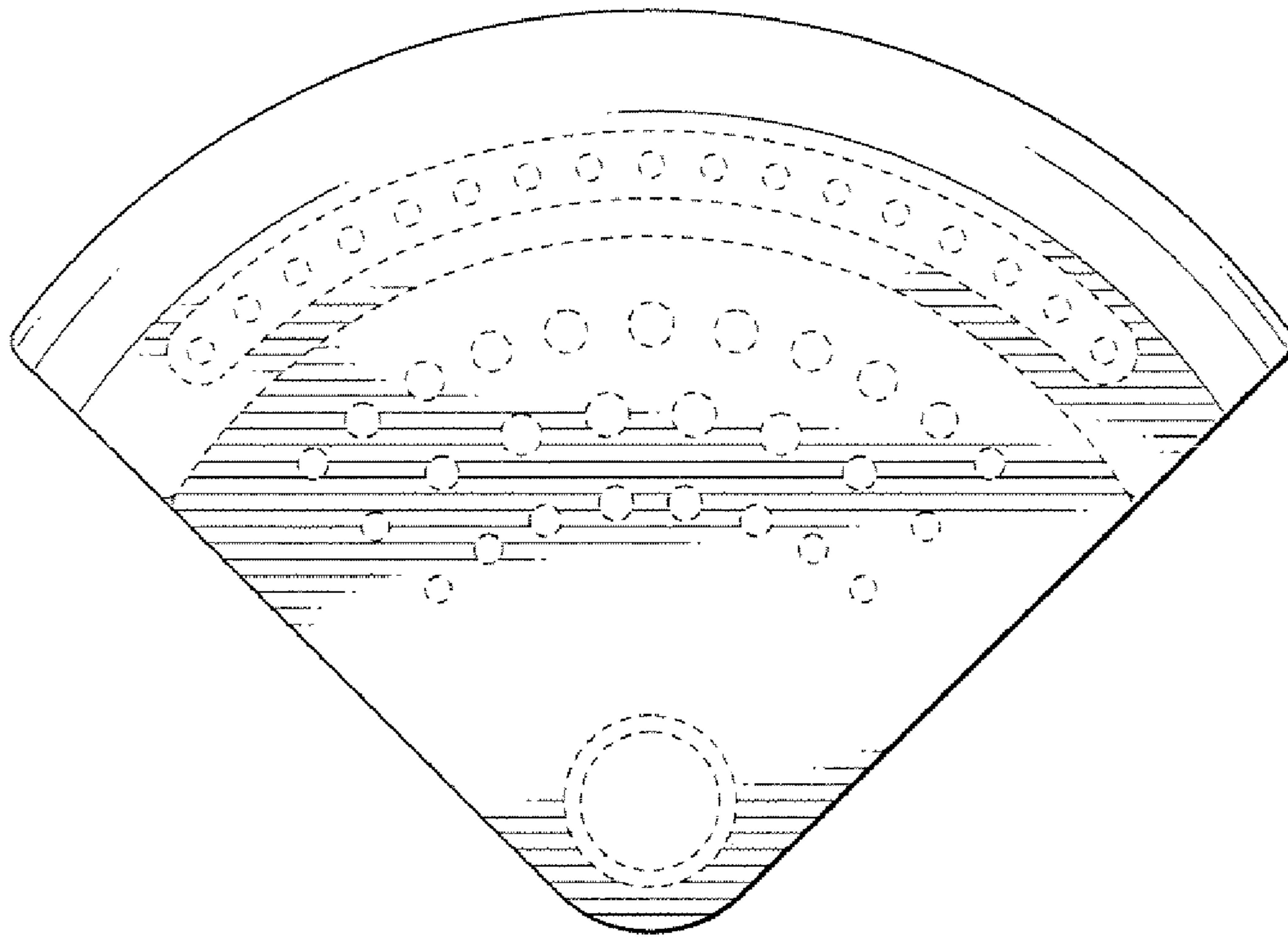

FIG. 11

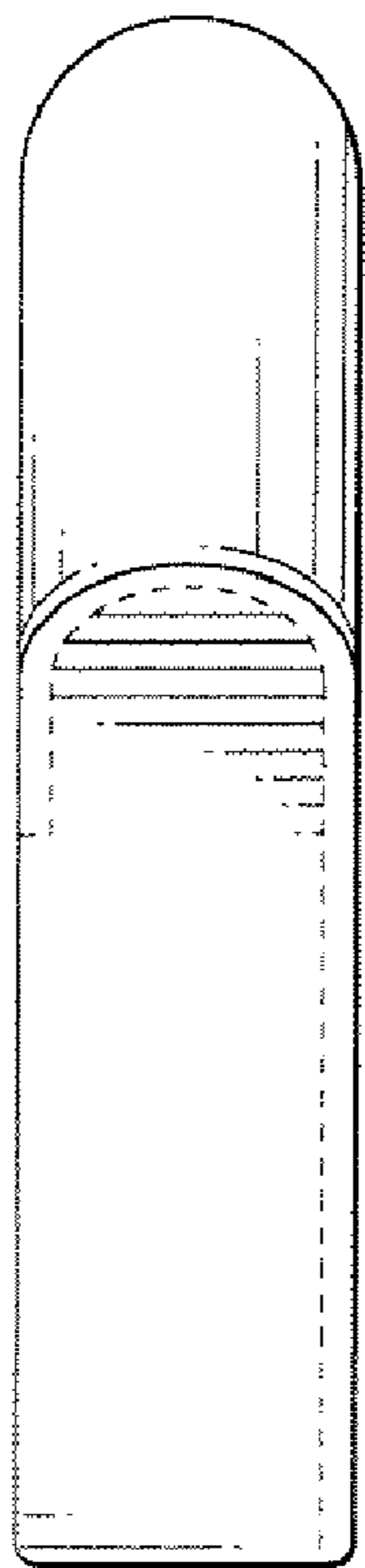

FIG. 12



FIG. 13

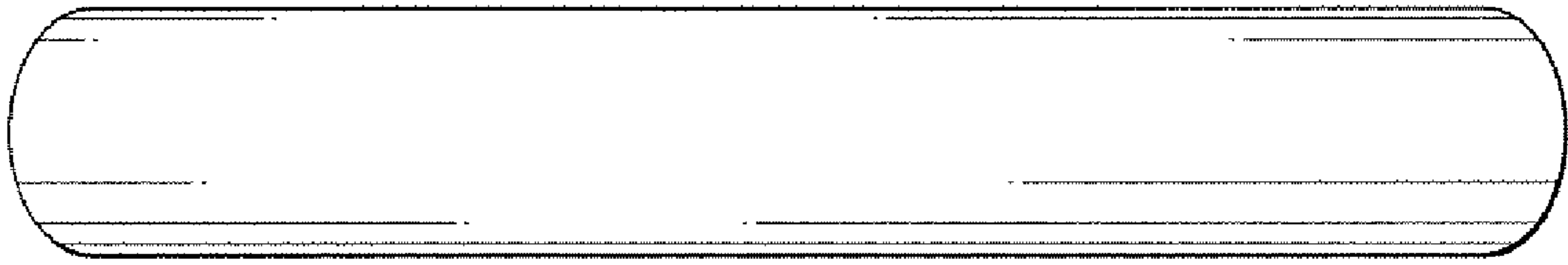

FIG. 14

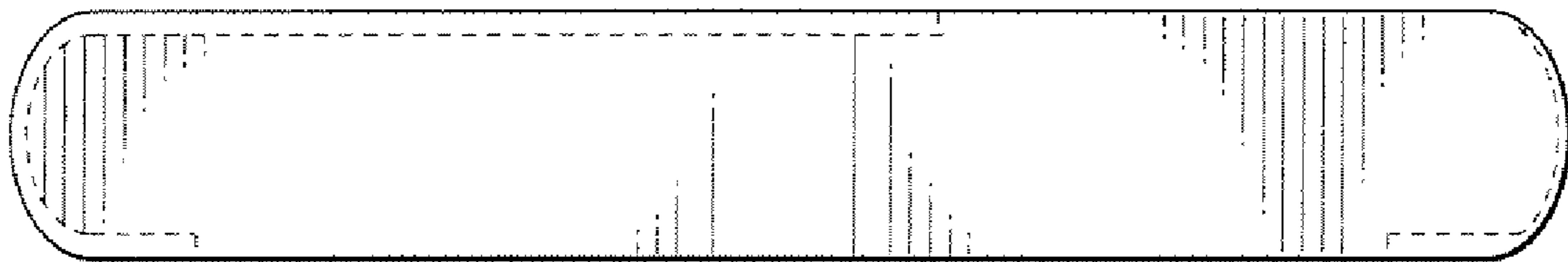

FIG. 15