



US00D581502S

(12) **United States Design Patent**
Gao

(10) **Patent No.:** **US D581,502 S**

(45) **Date of Patent:** **** Nov. 25, 2008**

(54) **HEATER**

(76) **Inventor:** **Tianyu Gao**, Jinke Bldg., 8 Qiongyu Rd,
Science & Technology Park, Nanshan
Dist., Shenzhen (CN)

(**) **Term:** **14 Years**

(21) **Appl. No.:** **29/274,741**

(22) **Filed:** **May 21, 2007**

(30) **Foreign Application Priority Data**

Dec. 14, 2006 (CN) 2006 3 0155468

(51) **LOC (8) Cl.** **23-03**

(52) **U.S. Cl.** **D23/332**

(58) **Field of Classification Search** D23/314,
D23/317, 332, 342, 333, 334, 335, 337, 351,
D23/355, 378, 370, 387, 364, 336, 341, 383;
237/56, 67, 61, 62; 416/244 R, 247 R, 53.1,
416/53.2, 53.3; 392/365, 367, 347, 350,
392/373, 407, 433, 78 A

See application file for complete search history.

(56) **References Cited**

U.S. PATENT DOCUMENTS

D290,997 S *	7/1987	Utsuki et al.	D23/378
D329,284 S *	9/1992	Patton	D23/378
D332,655 S *	1/1993	Lytle et al.	D23/378
D433,494 S *	11/2000	Pinchuk et al.	D23/364
D468,006 S *	12/2002	Gao	D23/336
D486,216 S *	2/2004	Wilson, Jr.	D23/378
D487,141 S *	2/2004	Gao	D23/335
D499,473 S *	12/2004	Ching	D23/332
D506,538 S *	6/2005	Christianson	D23/364

D508,734 S *	8/2005	Gao	D23/335
D510,618 S *	10/2005	Dooley	D23/335
D510,619 S *	10/2005	Gao	D23/335
D510,989 S *	10/2005	Dooley	D23/335
D516,687 S *	3/2006	Shapiro	D23/332
D519,196 S *	4/2006	Blateri	D23/335
D521,136 S *	5/2006	Tseng et al.	D23/364
D532,884 S *	11/2006	Ching	D23/335
D533,264 S *	12/2006	Blateri	D23/335
D543,612 S *	5/2007	Fok	D23/336
D545,951 S *	7/2007	Bucher et al.	D23/335
D546,430 S *	7/2007	Ching et al.	D23/342
2004/0197091 A1 *	10/2004	Orr et al.	392/365

* cited by examiner

Primary Examiner—Louis S Zarfaz

Assistant Examiner—Ania K Dworzecka

(74) *Attorney, Agent, or Firm*—Birch, Stewart, Kolasch & Birch LLP

(57) **CLAIM**

The ornamental design for a heater, as shown and described.

DESCRIPTION

FIG. 1 is a front view of a heater showing my new design;

FIG. 2 is a rear view thereof;

FIG. 3 is a left side view thereof;

FIG. 4 is a right side view thereof;

FIG. 5 is a top plan view thereof; and,

FIG. 6 is a perspective view thereof.

The portions of the heater shown in broken line form no part of the claimed design.

1 Claim, 6 Drawing Sheets

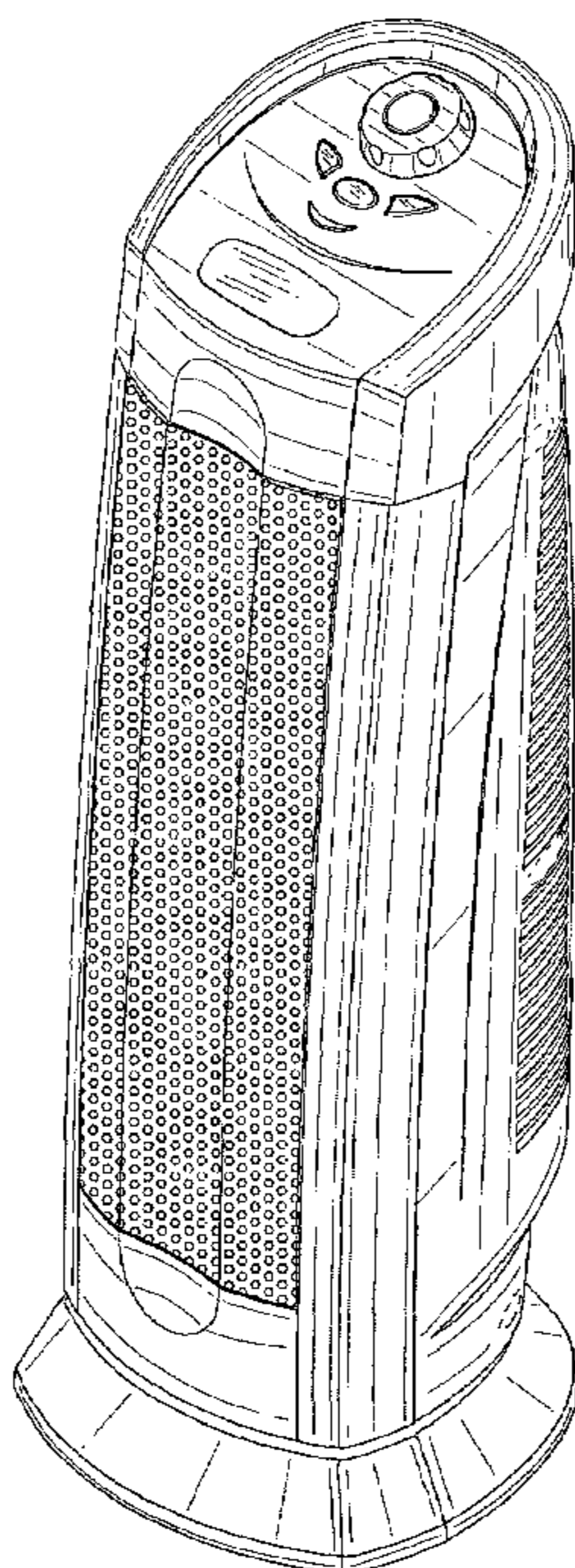

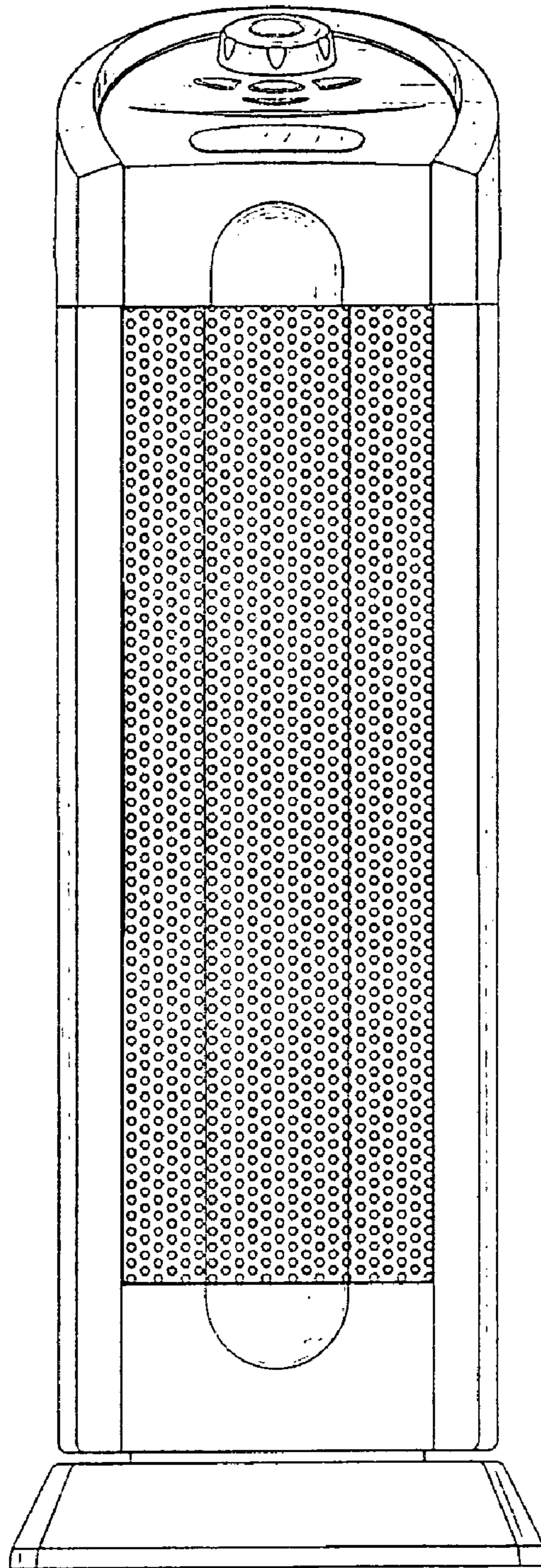

FIG. 1

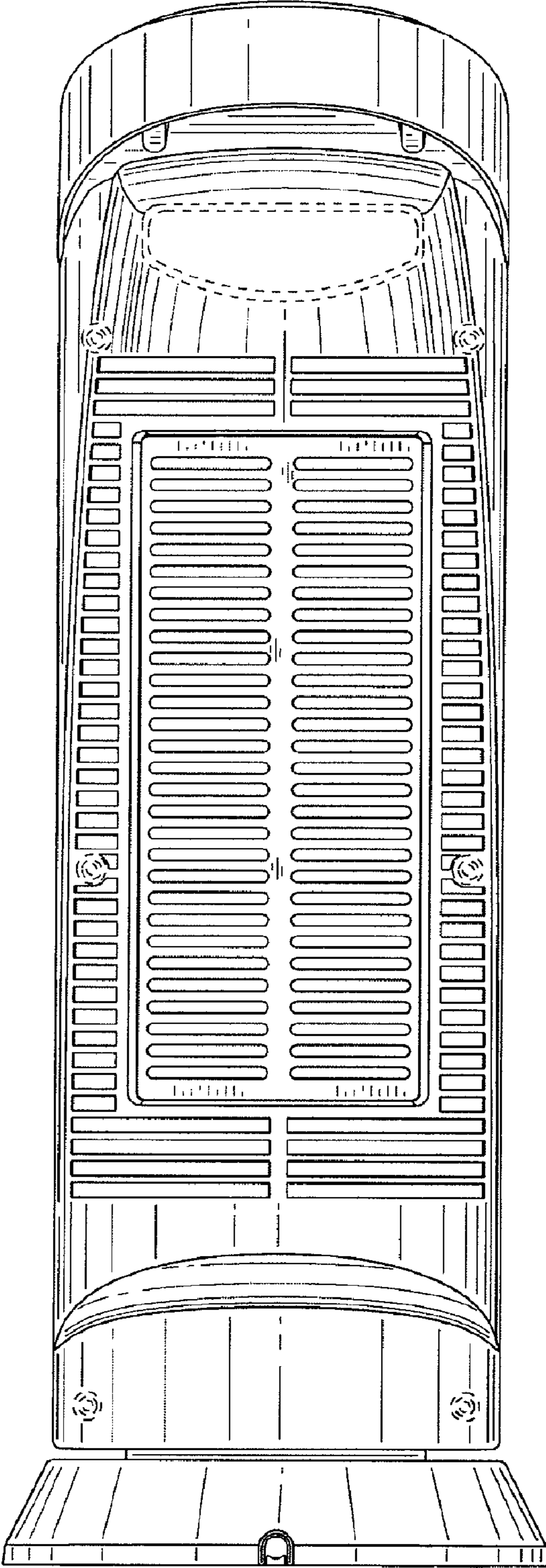

FIG. 2

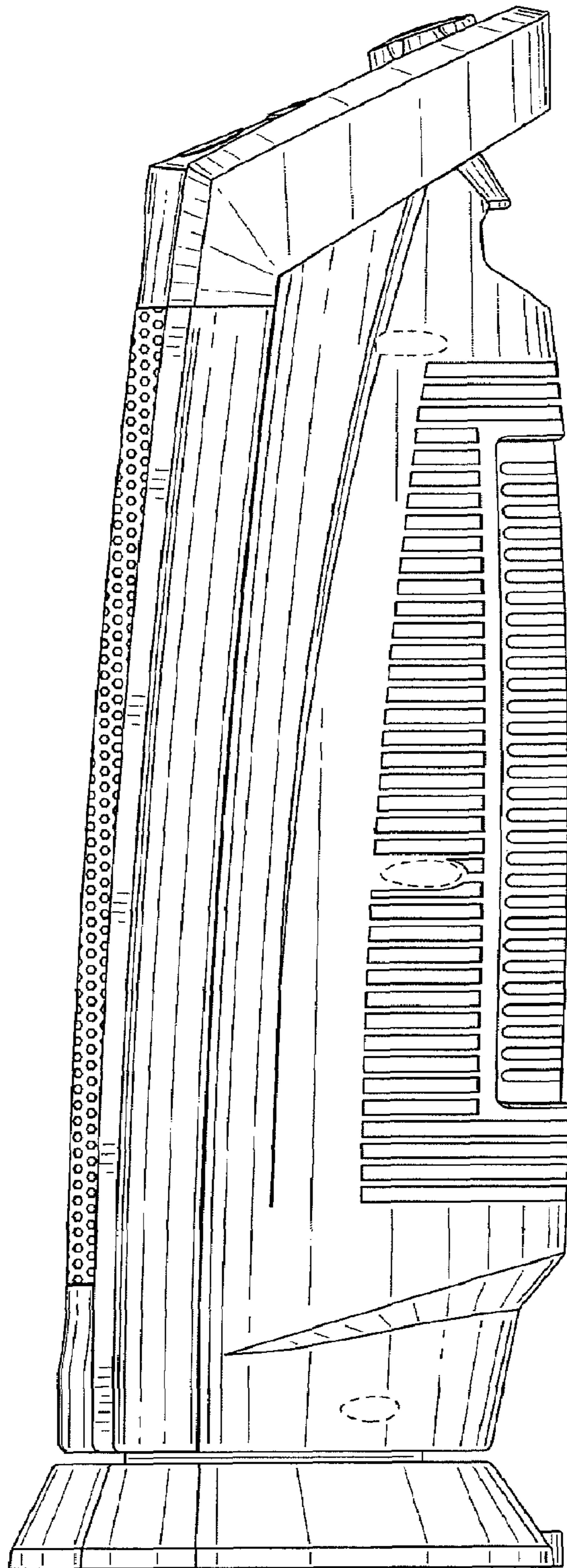

FIG. 3

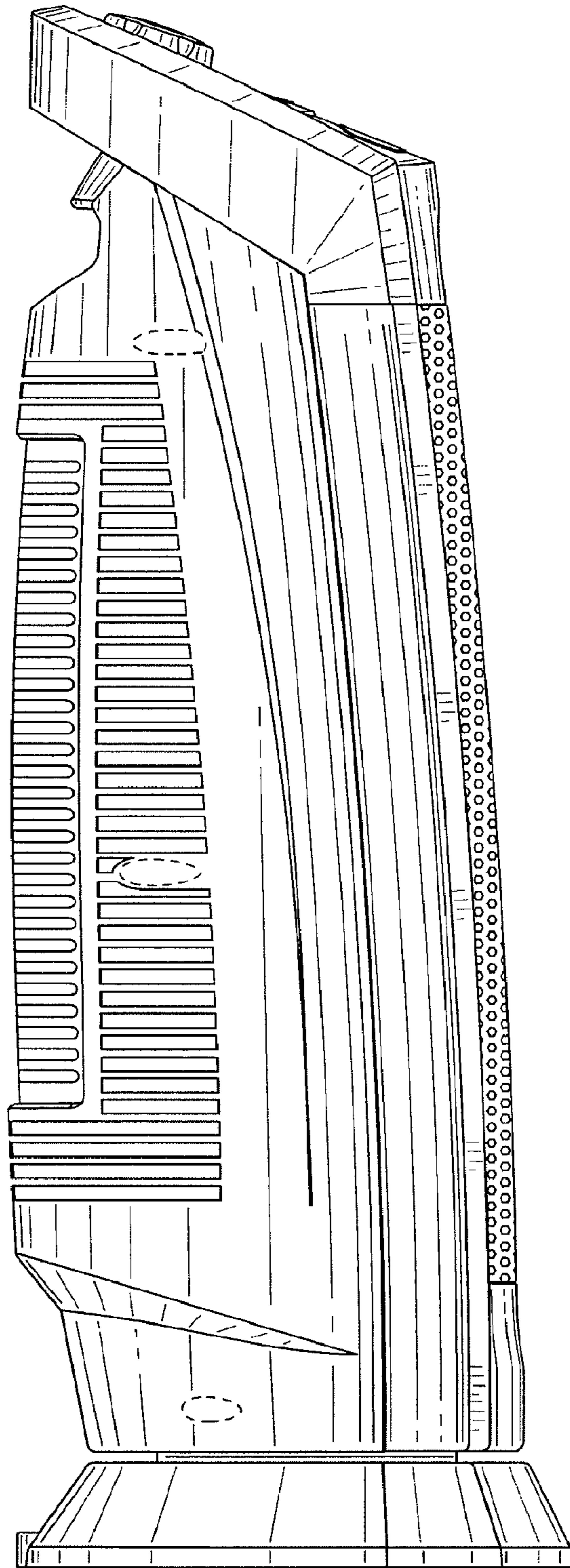

FIG. 4

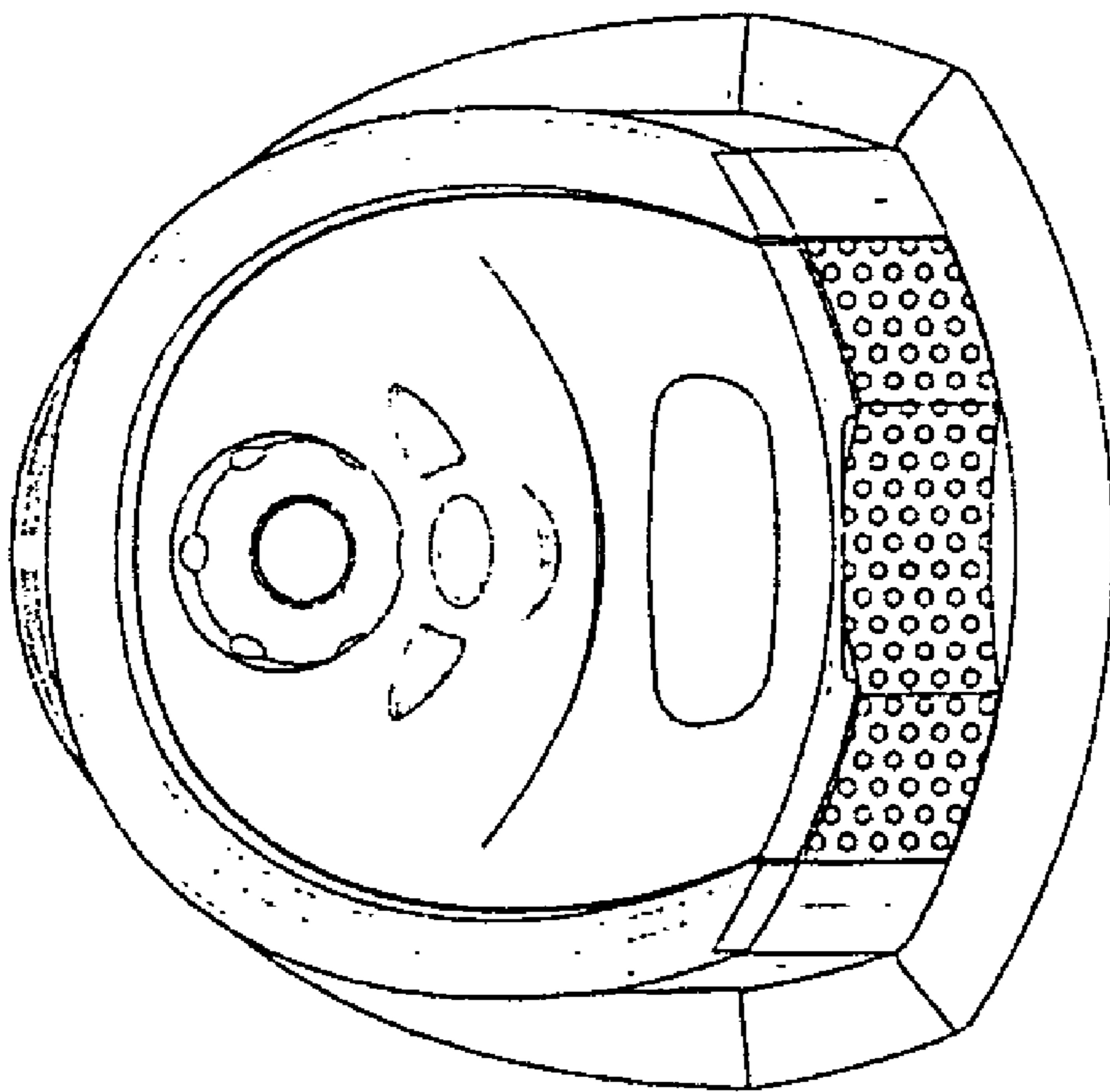

FIG. 5

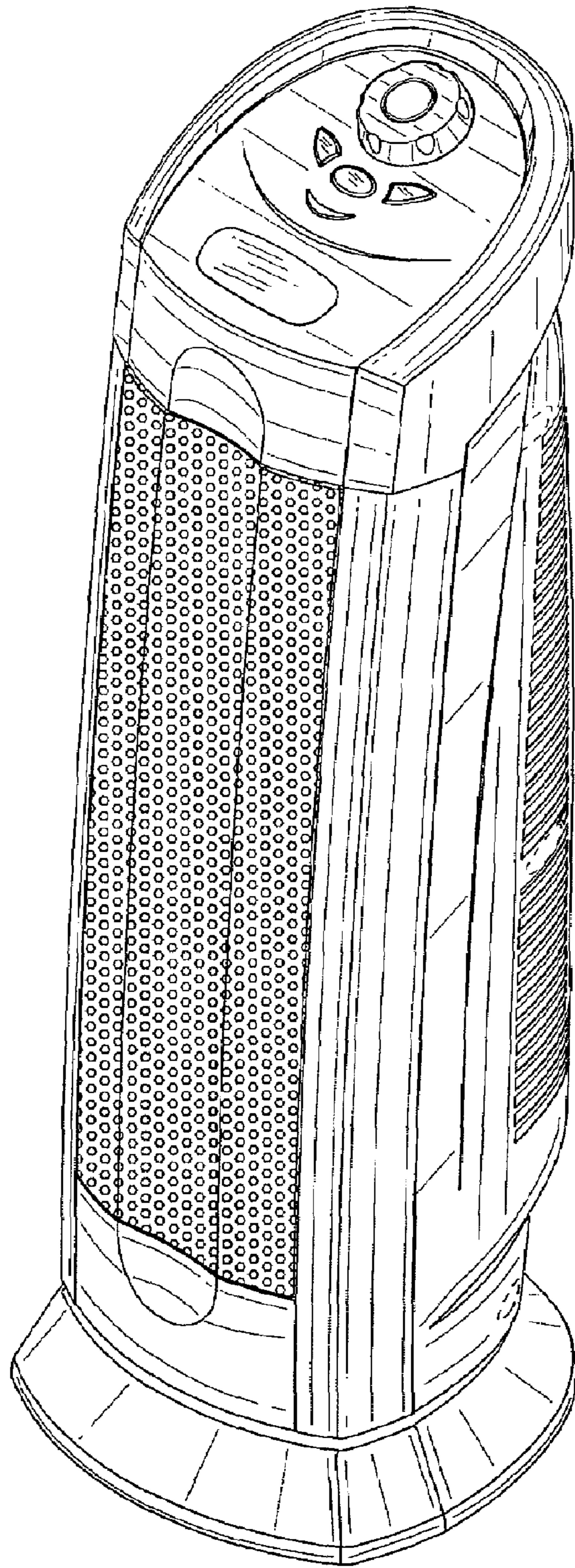

FIG. 6