



US00D581461S

(12) **United States Design Patent**  
**Li**

(10) **Patent No.:** **US D581,461 S**

(45) **Date of Patent:** **\*\* Nov. 25, 2008**

(54) **HIGHLIGHTER**

D566,360 S \* 4/2008 Ungaro ..... D32/35  
D573,183 S \* 7/2008 Qui et al. .... D19/36

(75) Inventor: **Liming Li**, Ningbo (CN)

(73) Assignee: **Beifa Group Ltd., Co.**, Ningbo (CN)

(\*\*) Term: **14 Years**

(21) Appl. No.: **29/284,665**

(22) Filed: **Sep. 12, 2007**

(30) **Foreign Application Priority Data**

Apr. 13, 2007 (CN) ..... 2007 3 0009297

(51) **LOC (8) Cl.** ..... **19-06**

(52) **U.S. Cl.** ..... **D19/48**

(58) **Field of Classification Search** ..... D19/35,  
D19/36, 41-51, 53-57; 24/11 F, 11 P, 11 R;  
401/52, 99, 100, 104-109, 192, 195, 196  
See application file for complete search history.

(56) **References Cited**

**U.S. PATENT DOCUMENTS**

D120,137 S \* 4/1940 Most ..... D19/48  
D439,336 S \* 3/2001 Najmi ..... D24/142  
6,206,595 B1 \* 3/2001 Keda ..... 401/6  
D440,605 S \* 4/2001 Izushima ..... D19/55  
D450,766 S \* 11/2001 Rosenbaum ..... D19/36  
D469,469 S 1/2003 Schminke  
D482,070 S 11/2003 Kennedy  
D486,860 S 2/2004 Hodge  
D497,389 S \* 10/2004 Katami ..... D19/46  
D497,641 S \* 10/2004 Tsuchikura ..... D19/43  
D541,340 S 4/2007 Qiu  
D559,311 S 1/2008 Qiu  
D563,470 S \* 3/2008 Qiu et al. .... D19/48

**OTHER PUBLICATIONS**

Qiu, Z., and L. Li, "Highlighter," U.S. Appl. No. 29/277,084, filed Feb. 13, 2007.

\* cited by examiner

*Primary Examiner*—Elizabeth A Albert

(74) *Attorney, Agent, or Firm*—Christensen O'Connor Johnson Kindness PLLC

(57) **CLAIM**

The ornamental design for a highlighter, as shown and described.

**DESCRIPTION**

FIG. 1 is a lower front left perspective view of a highlighter showing my new design;

FIG. 2 is an exploded front left perspective view thereof;

FIG. 3 is a front elevation view of the highlighter shown in FIG. 1, with the cap removed and placed on the opposite end of the highlighter;

FIG. 4 is a top plan view of the highlighter shown in FIG. 1;

FIG. 5 is a bottom plan view thereof;

FIG. 6 is a front elevation view thereof;

FIG. 7 is a right side elevation view thereof;

FIG. 8 is a rear elevation view thereof; and,

FIG. 9 is a left side elevation view thereof.

The broken lines shown in FIGS. 2 and 3 illustrate environment and form no part of the claimed design.

**1 Claim, 4 Drawing Sheets**

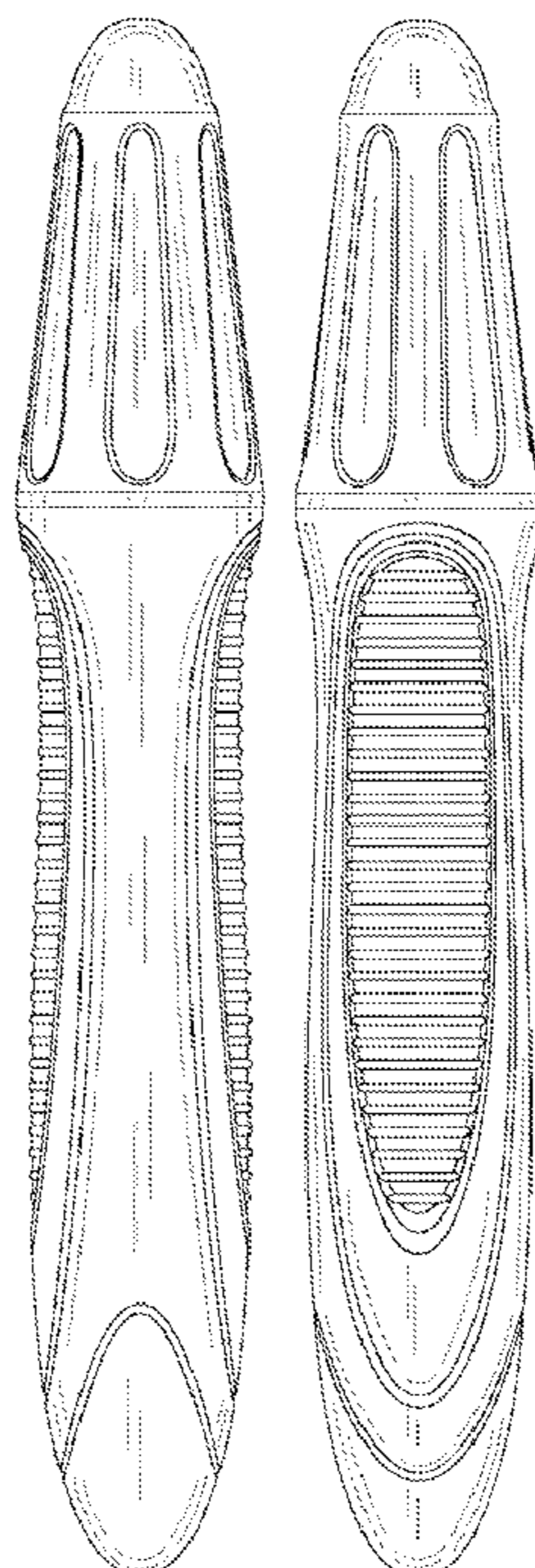

*Fig. 1.*

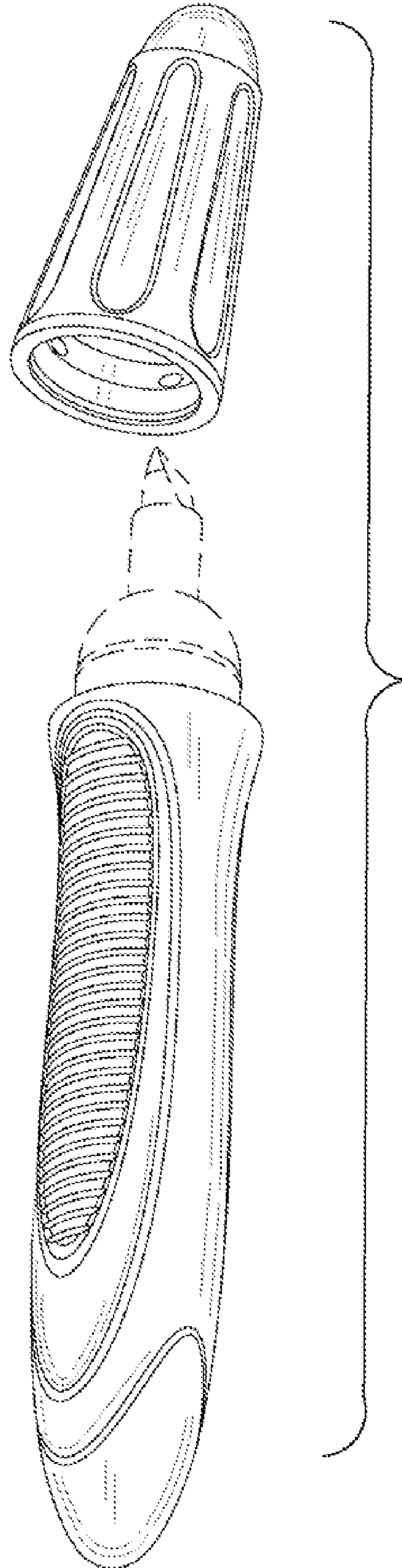
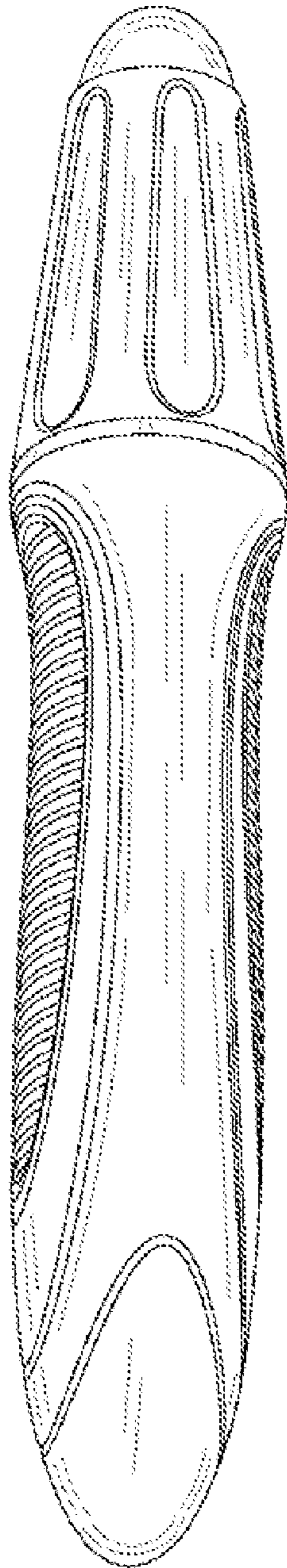

*Fig. 2.*

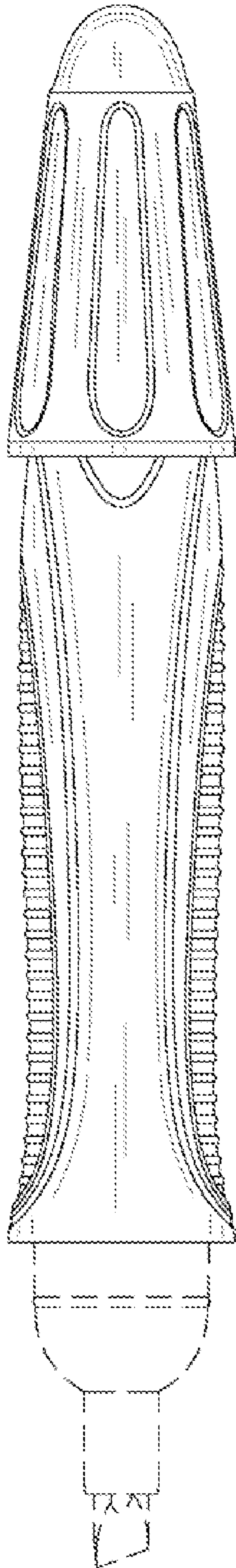

*Fig. 3.*

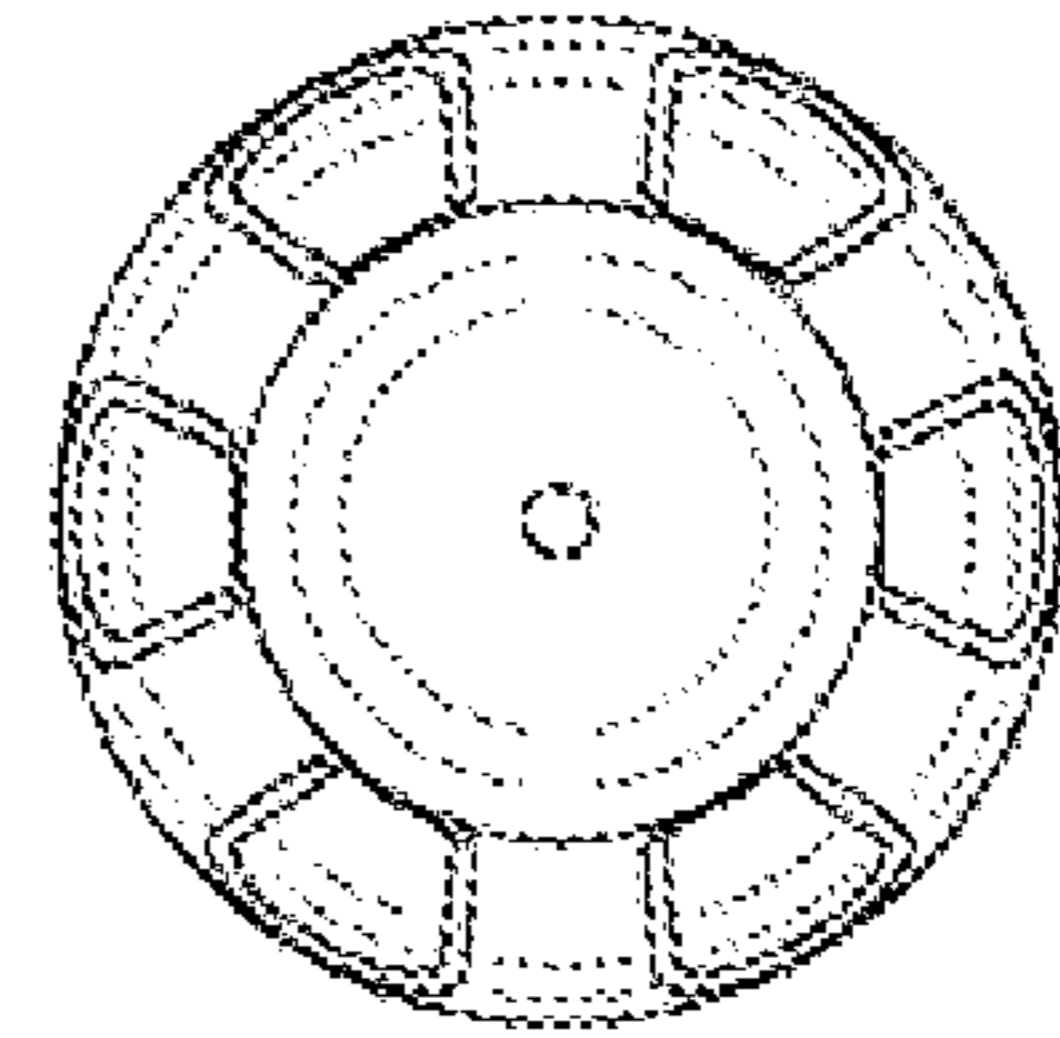

*Fig. 4.*

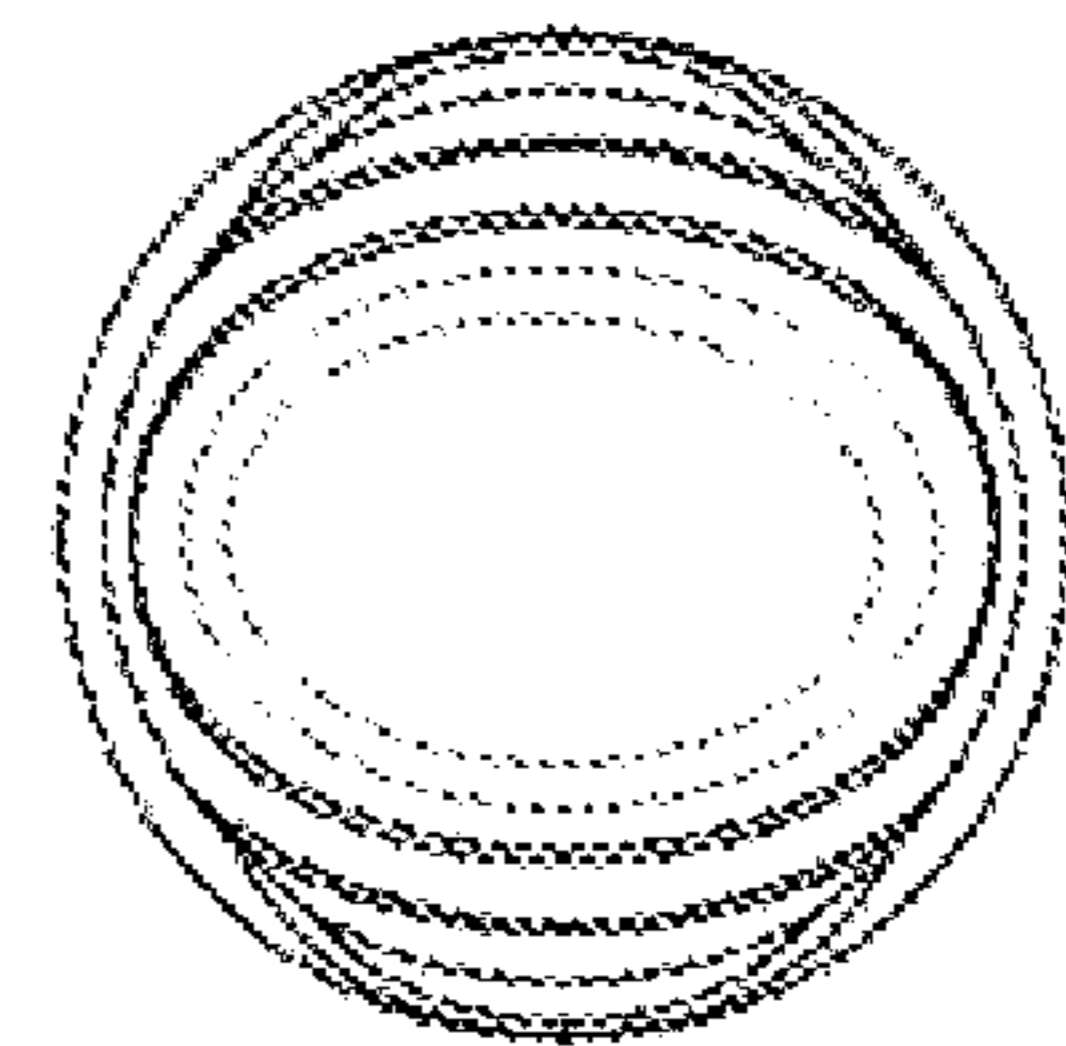

*Fig. 5.*

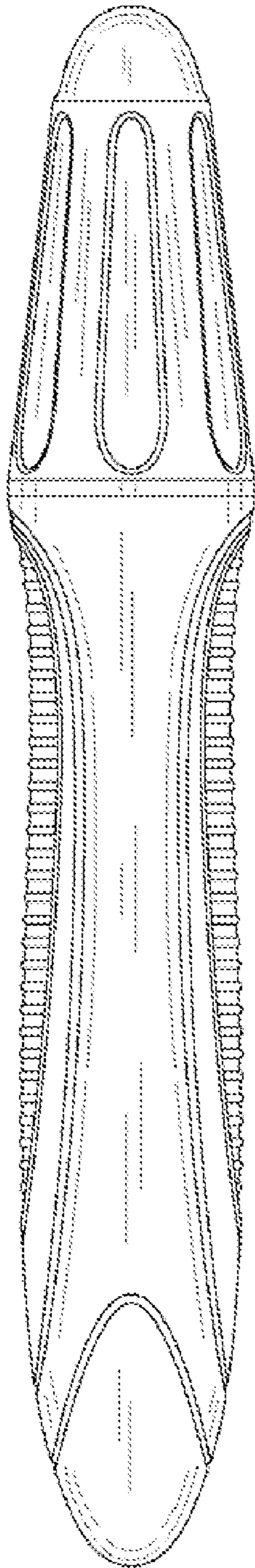

*Fig. 6.*

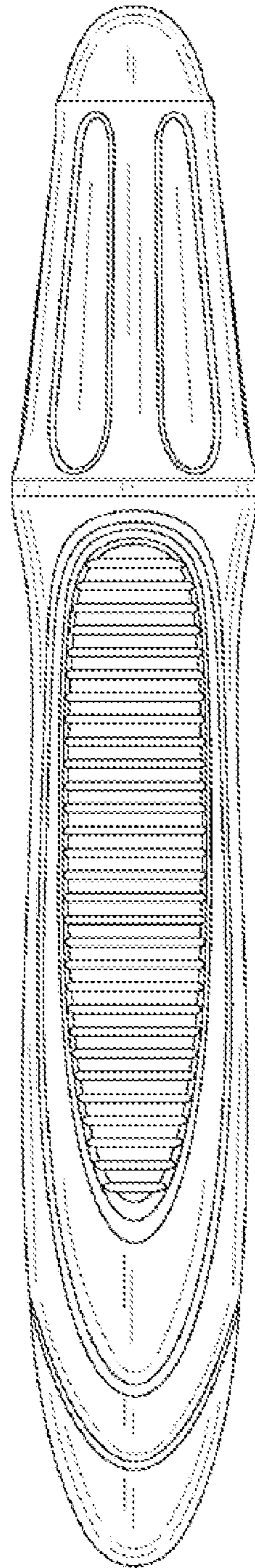

*Fig. 7.*

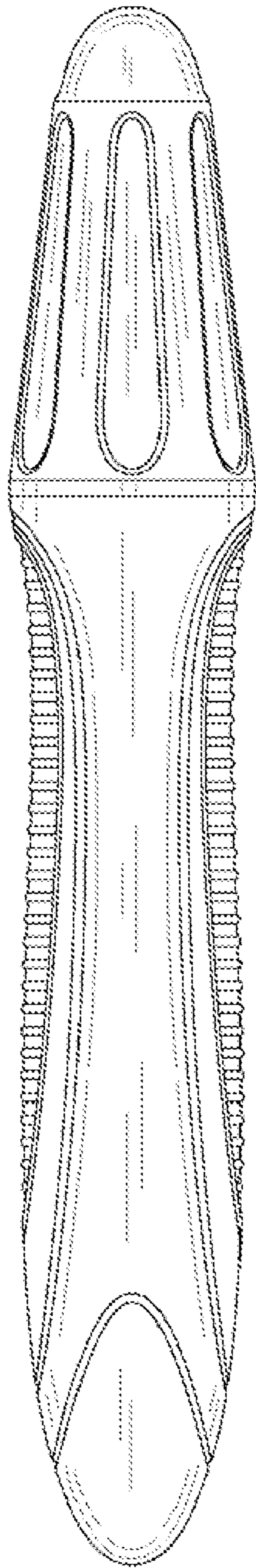

*Fig. 8.*

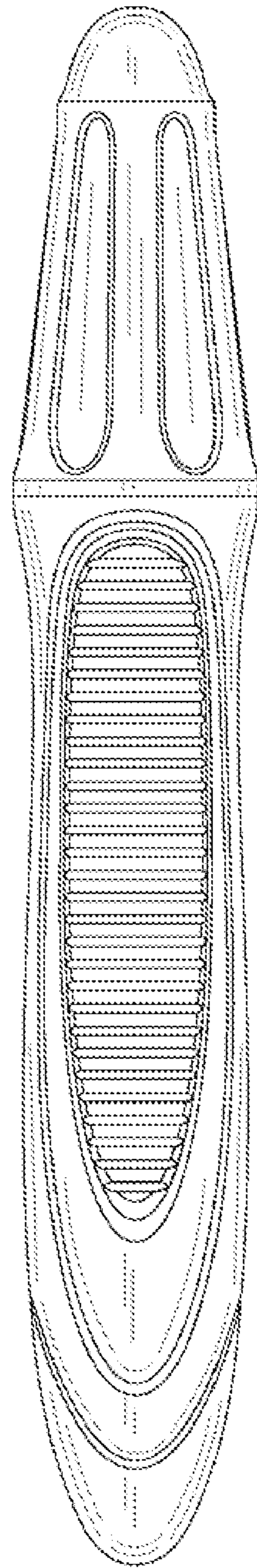

*Fig. 9.*

UNITED STATES PATENT AND TRADEMARK OFFICE  
**CERTIFICATE OF CORRECTION**

PATENT NO. : Des. 581,461 S  
APPLICATION NO. : 29/284665  
DATED : November 25, 2008  
INVENTOR(S) : L. Li

Page 1 of 1

It is certified that error appears in the above-identified patent and that said Letters Patent is hereby corrected as shown below:

**COLUMN**

**LINE**

Title Page,  
Item (73)

Assignee

“Beifa Group Ltd., Co.” should read  
--Beifa Group Co., Ltd.--

Signed and Sealed this

Eighteenth Day of August, 2009

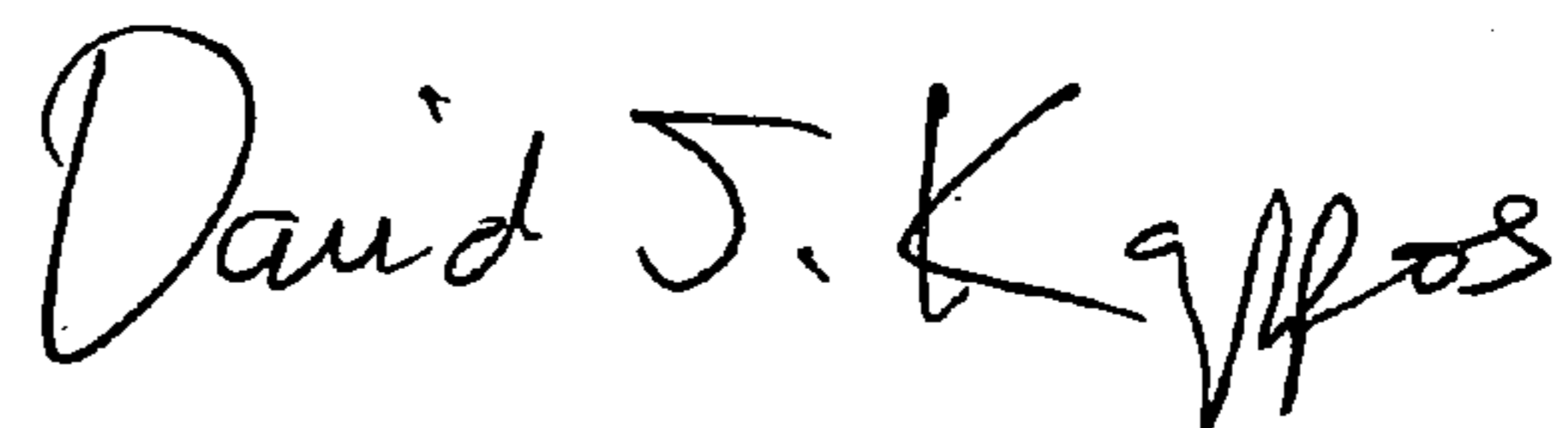

David J. Kappos  
*Director of the United States Patent and Trademark Office*