



US00D581273S

(12) **United States Design Patent**
Adamson et al.

(10) **Patent No.:** **US D581,273 S**

(45) **Date of Patent:** **** *Nov. 25, 2008**

(54) **BOTTLE**

(75) Inventors: **Edward Adamson**, London (GB);
Jonathon Shaw, London (GB); **Simon Salter**, London (GB)

(73) Assignee: **The Procter & Gamble Company**,
Cincinnati, OH (US)

(*) Notice: This patent is subject to a terminal disclaimer.

(**) Term: **14 Years**

(21) Appl. No.: **29/212,195**

(22) Filed: **Aug. 27, 2004**

(51) **LOC (8) Cl.** **09-01**

(52) **U.S. Cl.** **D9/516**

(58) **Field of Classification Search** D9/655-664,
D9/682-694, 715, 718-719, 723-729, 516,
D9/522-523, 527-528, 541-544, 546, 549,
D9/551-552, 561, 563, 565, 567-568, 570,
D9/572-575, 435; 215/12.1-12.2, 13.1,
215/382-384, 396, 398

See application file for complete search history.

(56) **References Cited**

U.S. PATENT DOCUMENTS

D213,172 S * 1/1969 Muller D9/523
D250,393 S * 11/1978 Shortino D9/523
D287,227 S * 12/1986 Turnbull D9/523
D315,671 S * 3/1991 Zaragoza D9/523
D319,972 S * 9/1991 Segati et al. D9/523
D330,515 S * 10/1992 Patel et al. D9/523
D331,195 S * 11/1992 Weckman D9/543

D358,990 S * 6/1995 Wilson et al. D9/523
D392,567 S * 3/1998 Dumont et al. D9/523
D403,588 S * 1/1999 Jungmann D9/523
D406,765 S * 3/1999 Zimmer et al. D9/523
D431,471 S * 10/2000 Large D9/523
D447,954 S * 9/2001 Cummings D9/530
D487,401 S * 3/2004 Cotton et al. D9/523
D493,723 S * 8/2004 Nelson et al. D9/523
D510,869 S * 10/2005 Gross et al. D9/523

* cited by examiner

Primary Examiner—Carol Rademaker

(74) *Attorney, Agent, or Firm*—David V. Upite; Amy I. Ahn-Roll

(57) **CLAIM**

The ornamental design for a bottle, as shown and described.

DESCRIPTION

FIG. 1 is a perspective view of a bottle, embodying the new design;

FIG. 2 is a front view thereof, the opposite back view is a mirror image thereto;

FIG. 3 is a right side view thereof;

FIG. 4 is a top view thereof;

FIG. 5 is a left side view thereof; and,

FIG. 6 is a bottom view thereof.

The dash-dash-dash broken lines in the drawings are for illustrative purposes only and form no part of the claimed design.

The dot-dash-dot broken lines in the drawings define the boundaries of the claimed design.

1 Claim, 3 Drawing Sheets

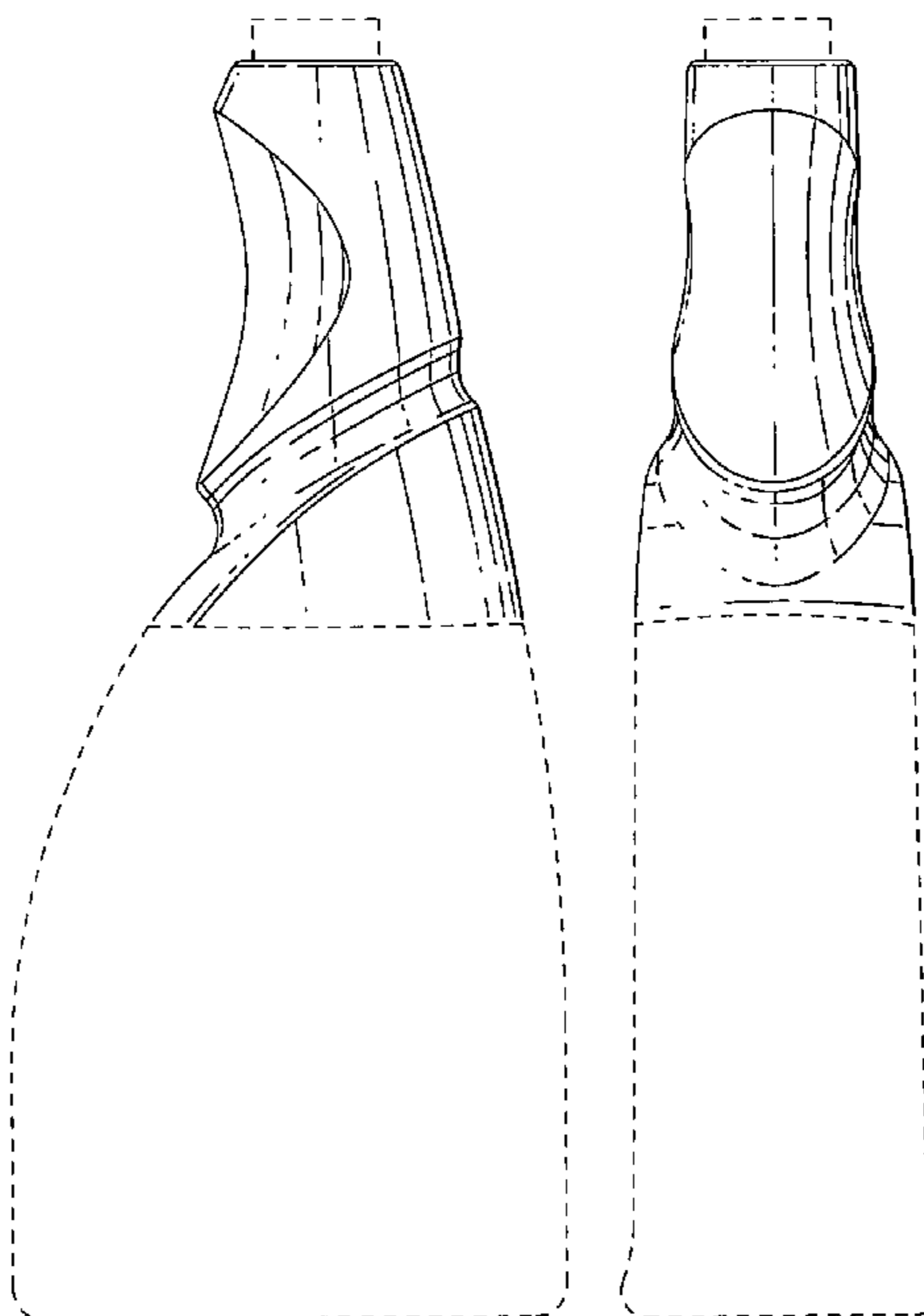

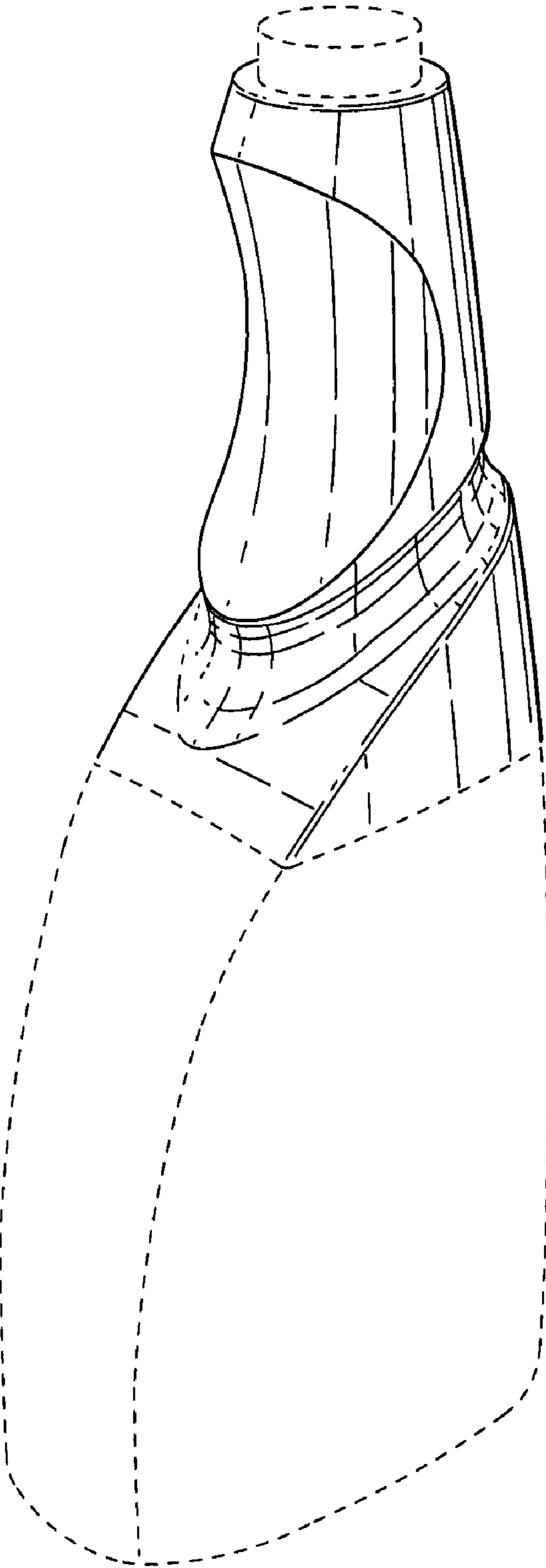

FIG. 1

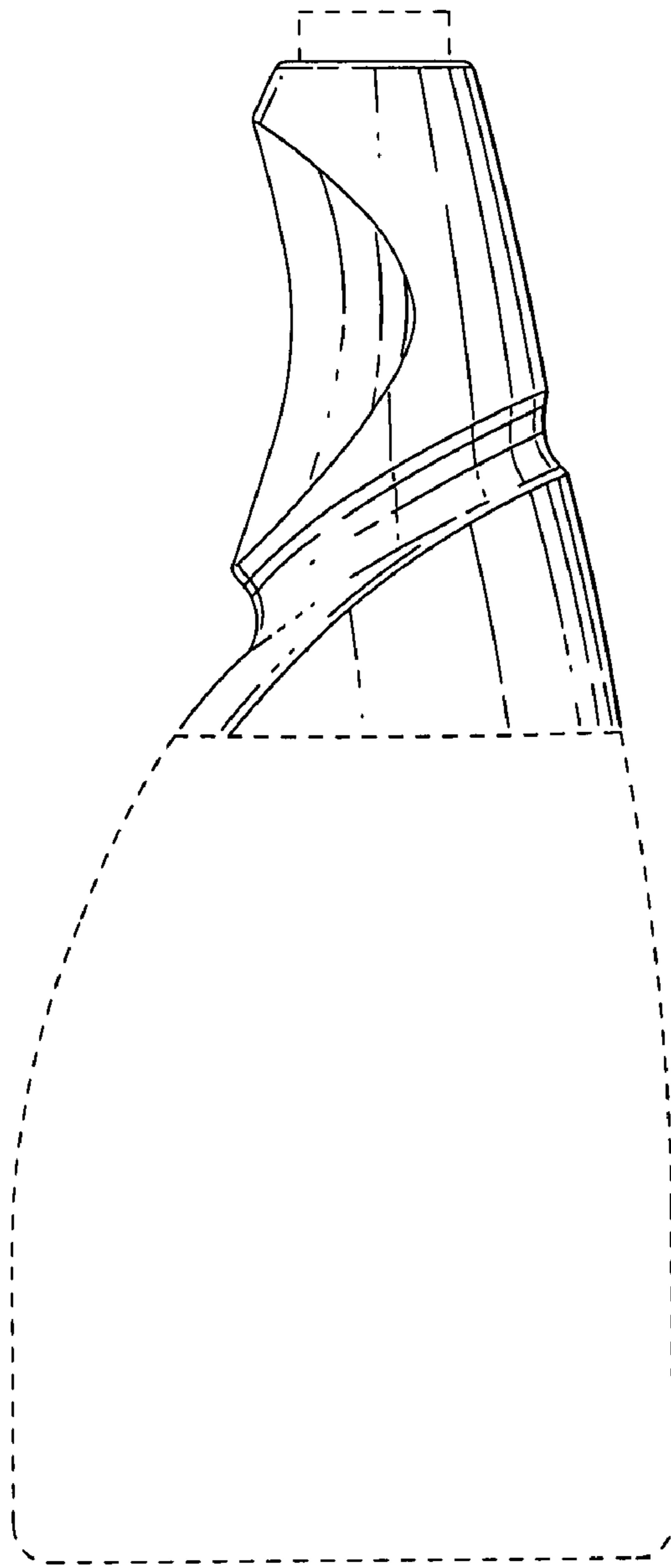

FIG. 2

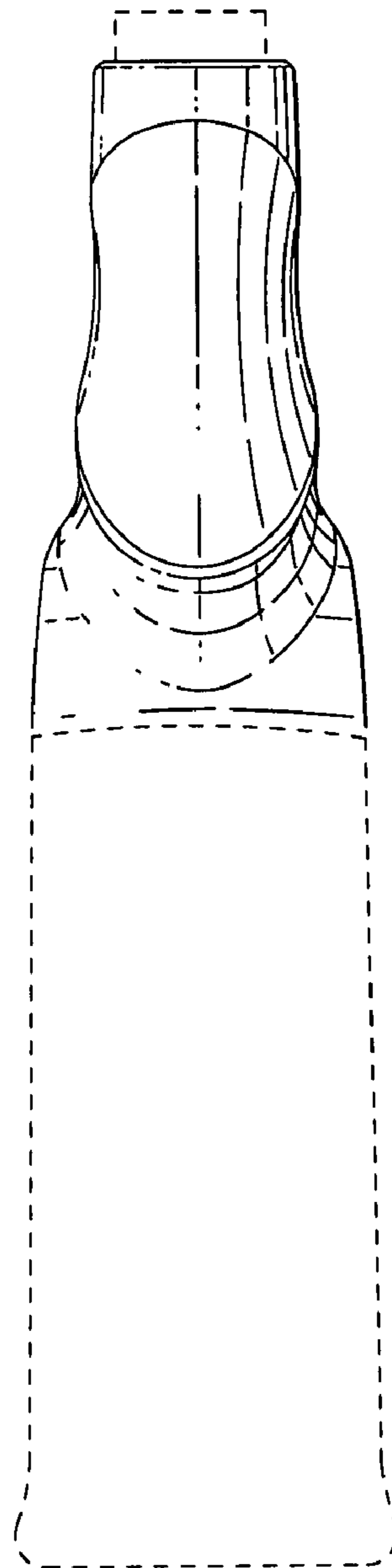

FIG. 3

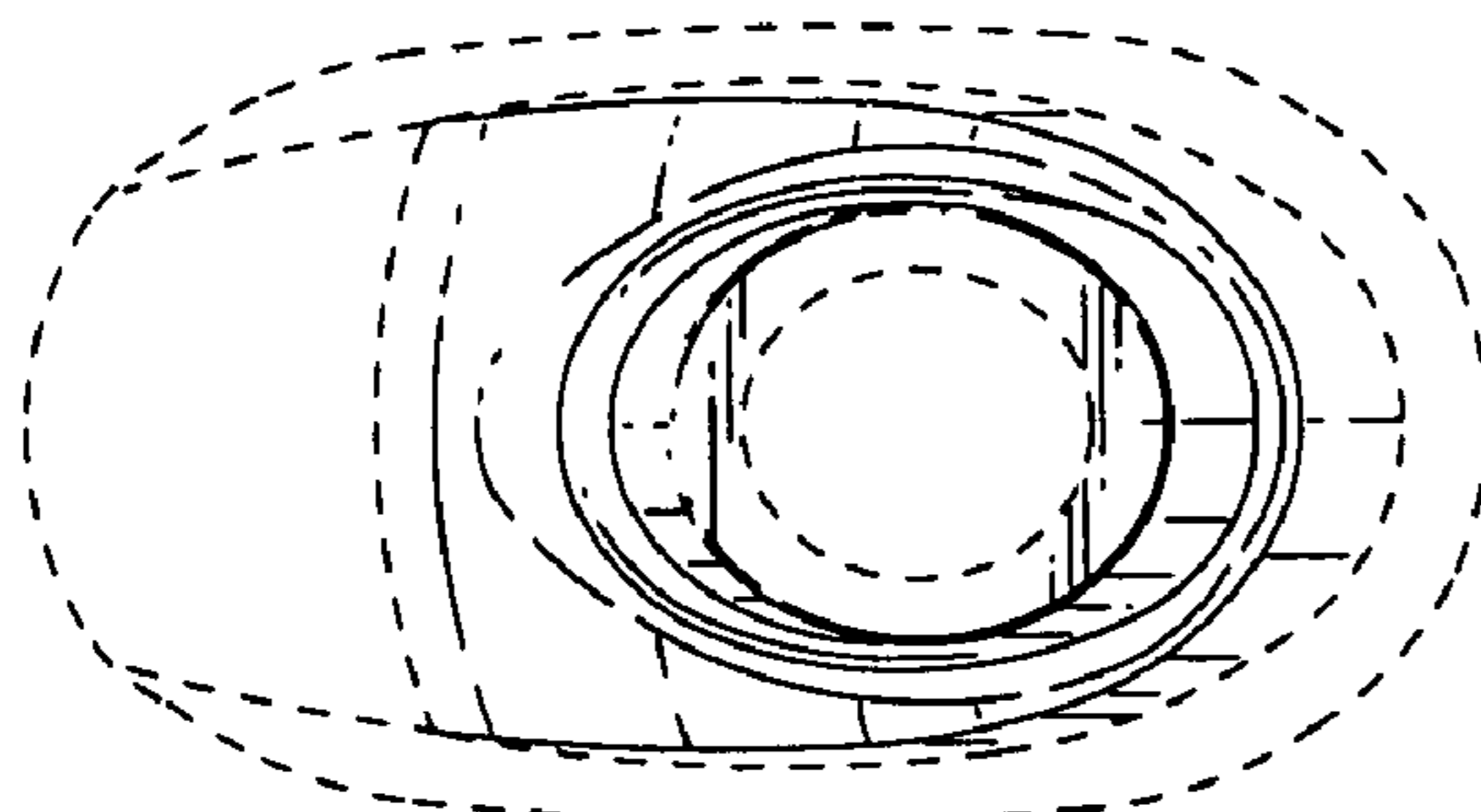

FIG. 4

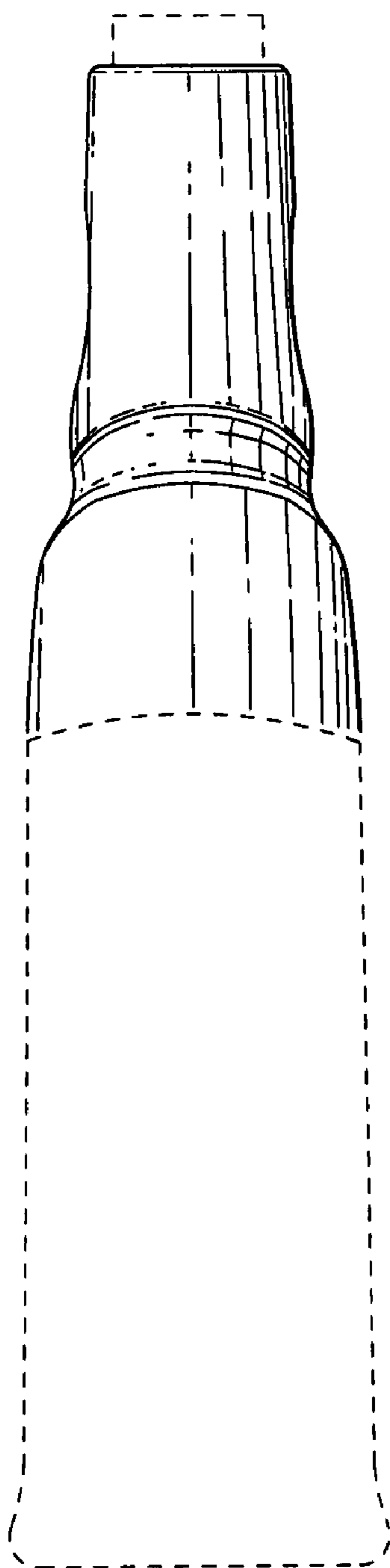

FIG. 5

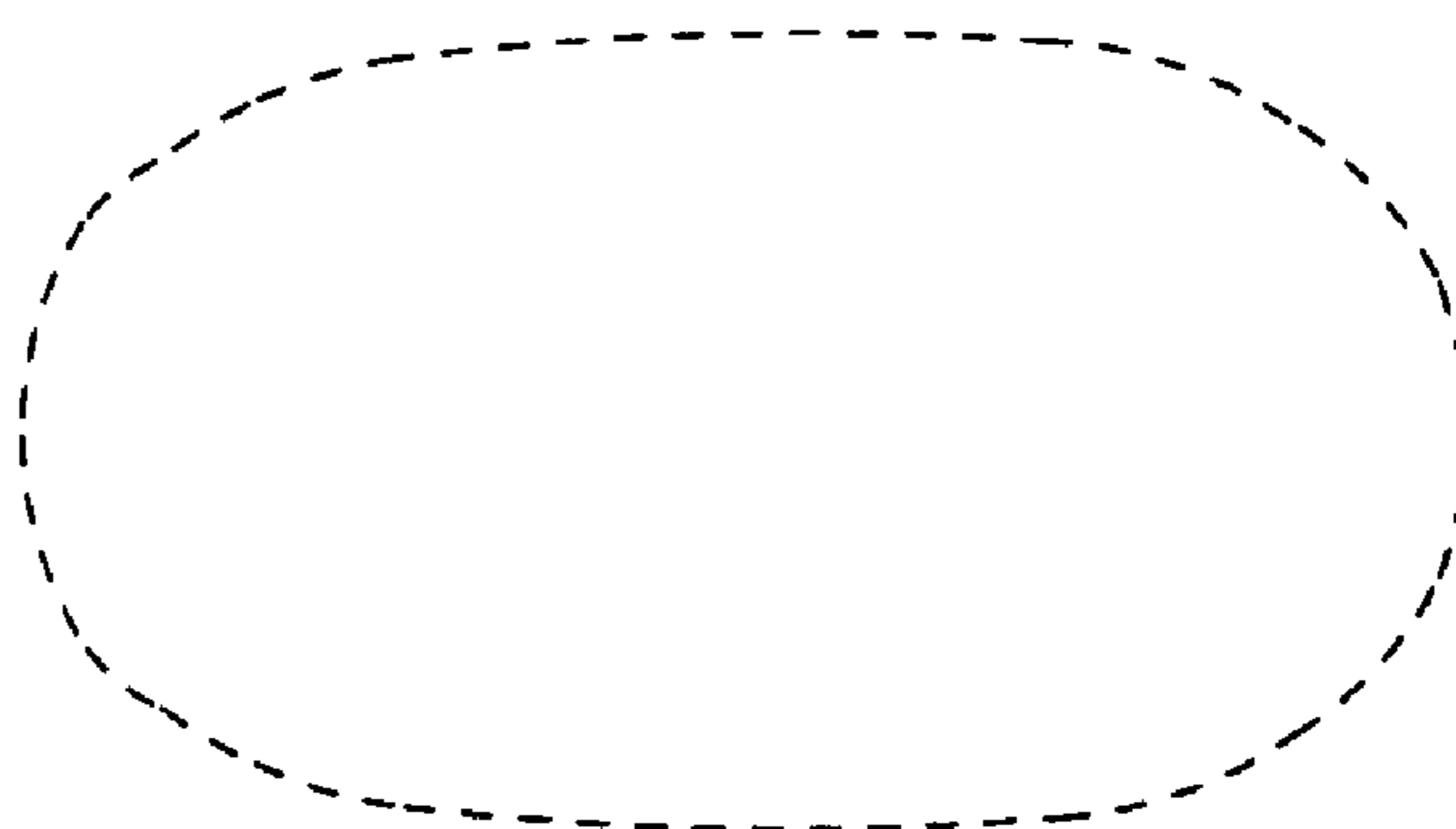

FIG. 6