



US00D581272S

(12) **United States Design Patent**
Yourist et al.

(10) **Patent No.:** **US D581,272 S**

(45) **Date of Patent:** **** *Nov. 25, 2008**

(54) **BOTTLE**

(75) Inventors: **Sheldon Yourist**, York, PA (US); **David P. Piccioli**, Auburn, NH (US); **Stephen R. Guerin**, Milford, NH (US)

(73) Assignee: **Graham Packaging Company, L.P.**, York, PA (US)

(*) Notice: This patent is subject to a terminal disclaimer.

(**) Term: **14 Years**

(21) Appl. No.: **29/265,363**

(22) Filed: **Aug. 31, 2006**

(51) **LOC (8) Cl.** **09-01**

(52) **U.S. Cl.** **D9/502**

(58) **Field of Classification Search** D9/500–504,
D9/516, 520, 549–550, 557, 682, 684–686,
D9/688–689, 692, 694, 743–746, 560, 570;
215/379–385; 220/660–662, 669–673, 675
See application file for complete search history.

(56) **References Cited**

U.S. PATENT DOCUMENTS

D361,039 S *	8/1995	Rokus	D9/531
D391,485 S *	3/1998	Biesecker et al.	D9/500
D411,802 S *	7/1999	Hestehave et al.	D9/500
D430,038 S *	8/2000	Young et al.	D9/549
D440,498 S *	4/2001	Buxton et al.	D9/773
D450,589 S *	11/2001	Haake et al.	D9/502
D464,264 S *	10/2002	Edson et al.	D9/502
D490,654 S *	6/2004	Allen et al.	D7/515

D517,923 S * 3/2006 Iturriza D9/652

* cited by examiner

Primary Examiner—Ian Simmons

Assistant Examiner—Dana L Sipos

(74) *Attorney, Agent, or Firm*—Knoble, Yoshida & Dunleavy, LLC

(57) **CLAIM**

The ornamental design for a bottle, as shown and described.

DESCRIPTION

FIG. 1 is a top, front, perspective view of a bottle showing our new design;

FIG. 2 is a front elevation view thereof;

FIG. 3 is a rear elevation view thereof;

FIG. 4 is a left side elevation view thereof;

FIG. 5 is a right side elevation view thereof;

FIG. 6 is a top plan view thereof;

FIG. 7 is a bottom plan view thereof;

FIG. 8 is a top plan view of the bottle of FIG. 9;

FIG. 9 is a top, front, perspective view a second embodiment of a bottle showing our new design;

FIG. 10 is a front elevation view thereof;

FIG. 11 is a rear elevation view thereof;

FIG. 12 is a left side elevation view thereof;

FIG. 13 is a right side elevation view thereof; and,

FIG. 14 is a bottom plan view thereof.

Elements shown in the drawings by broken lines are environment and are not part of the claimed design.

1 Claim, 13 Drawing Sheets

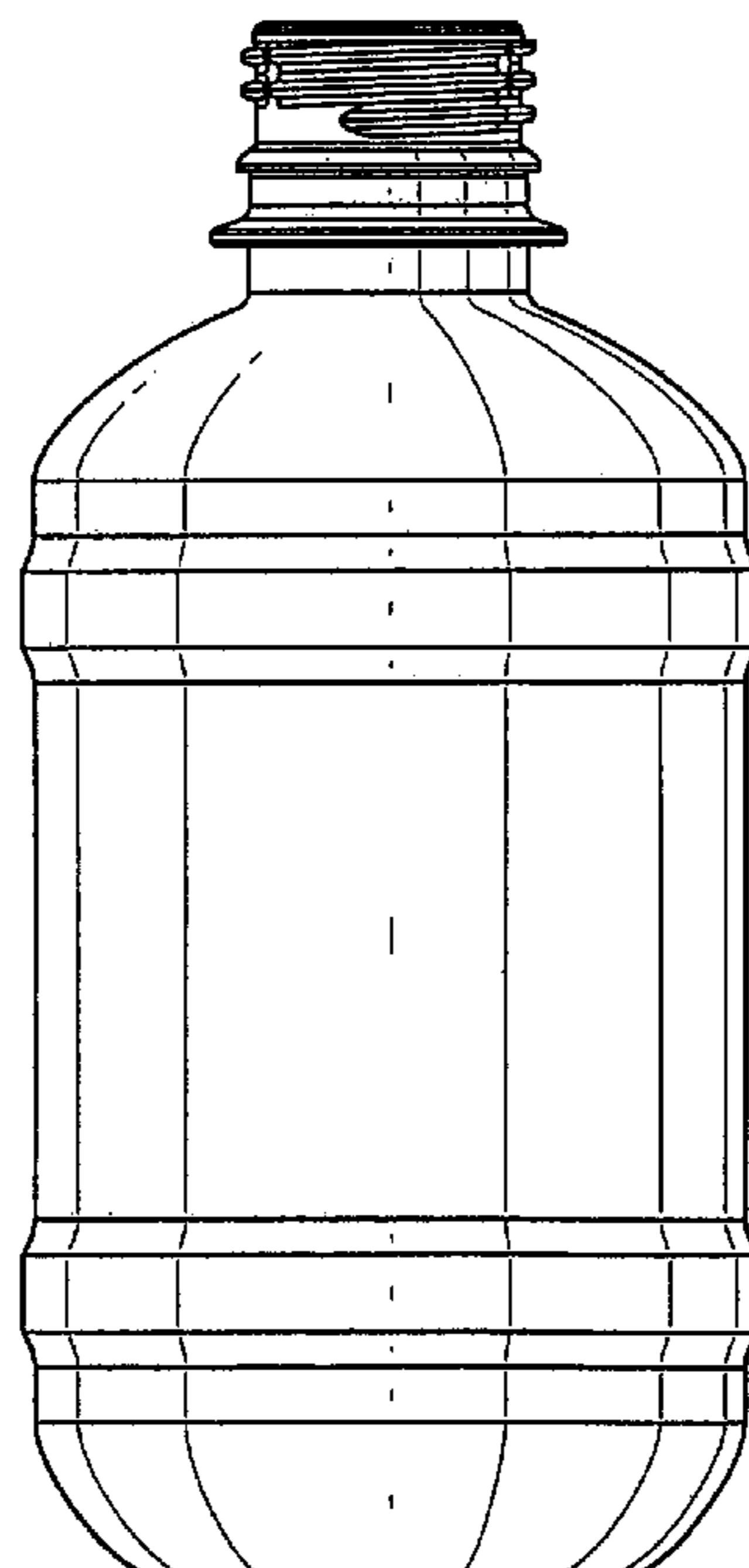

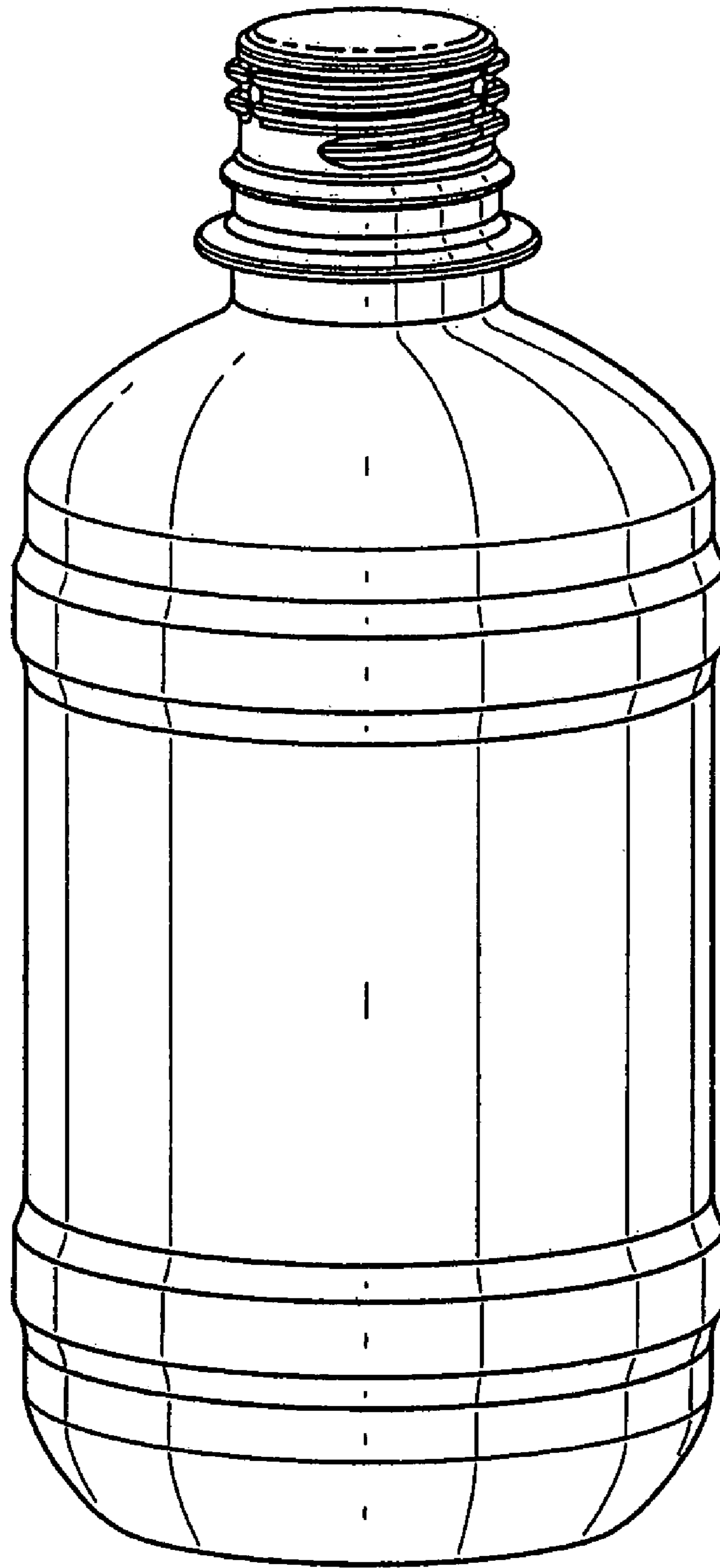

FIG. 1

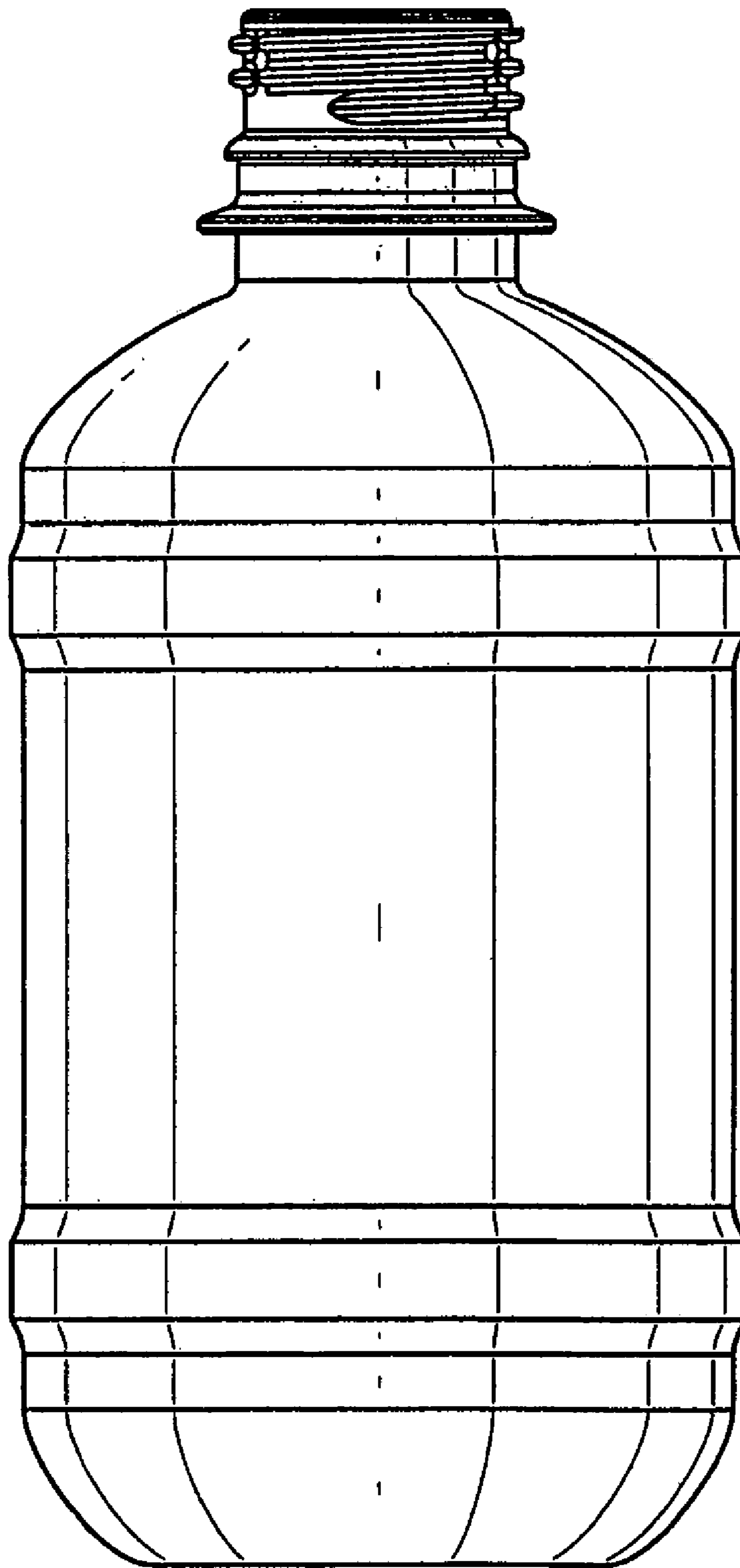

FIG. 2

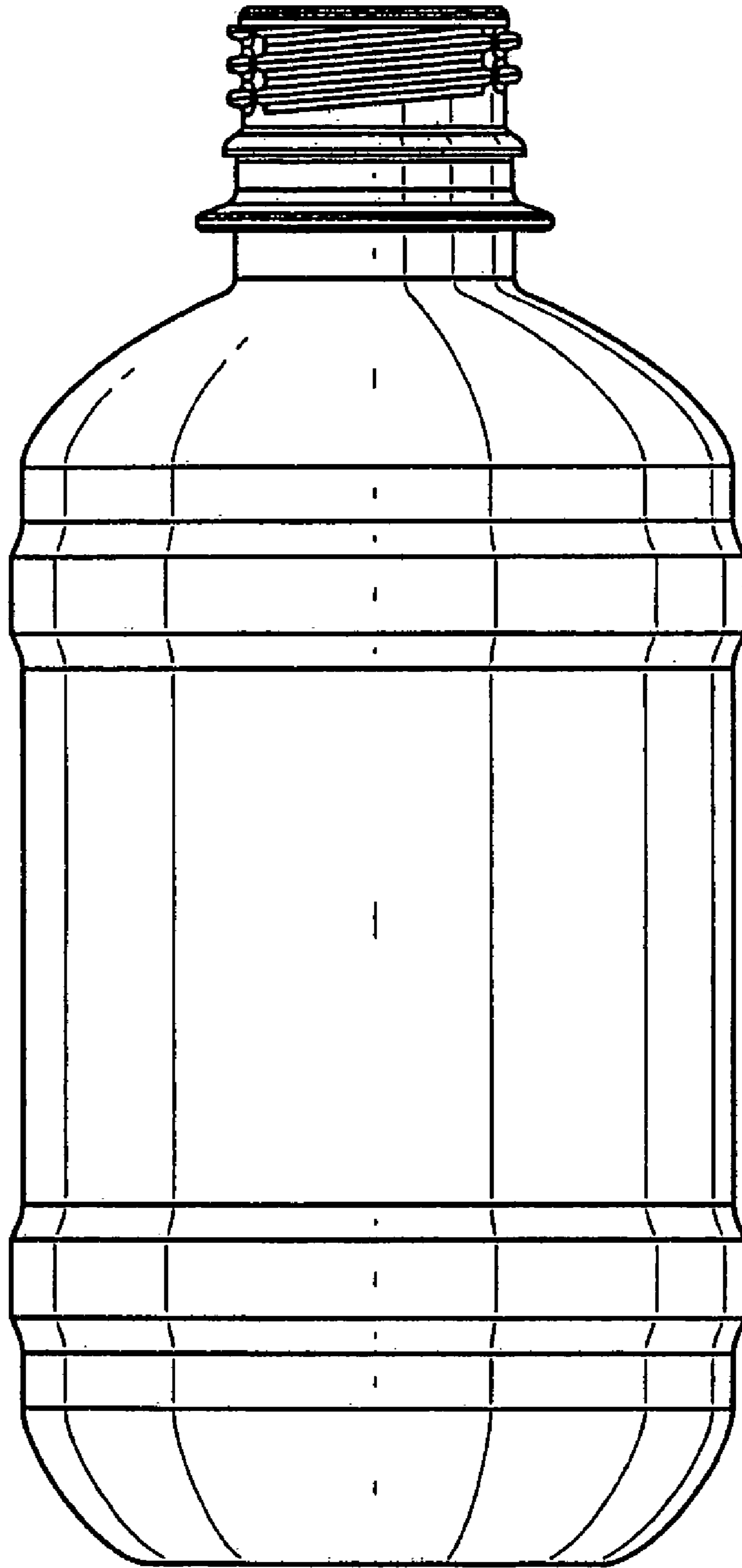

FIG. 3

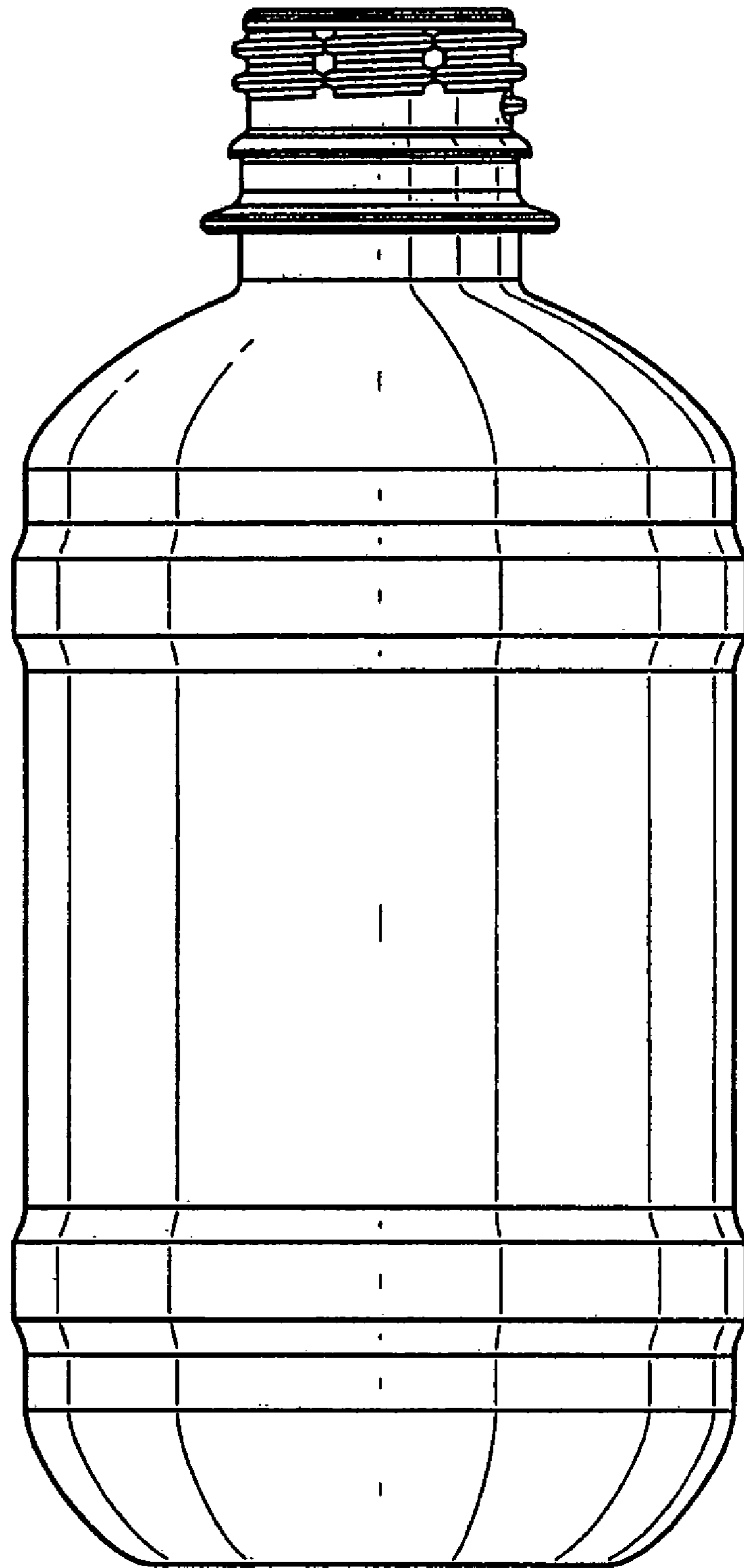

FIG. 4

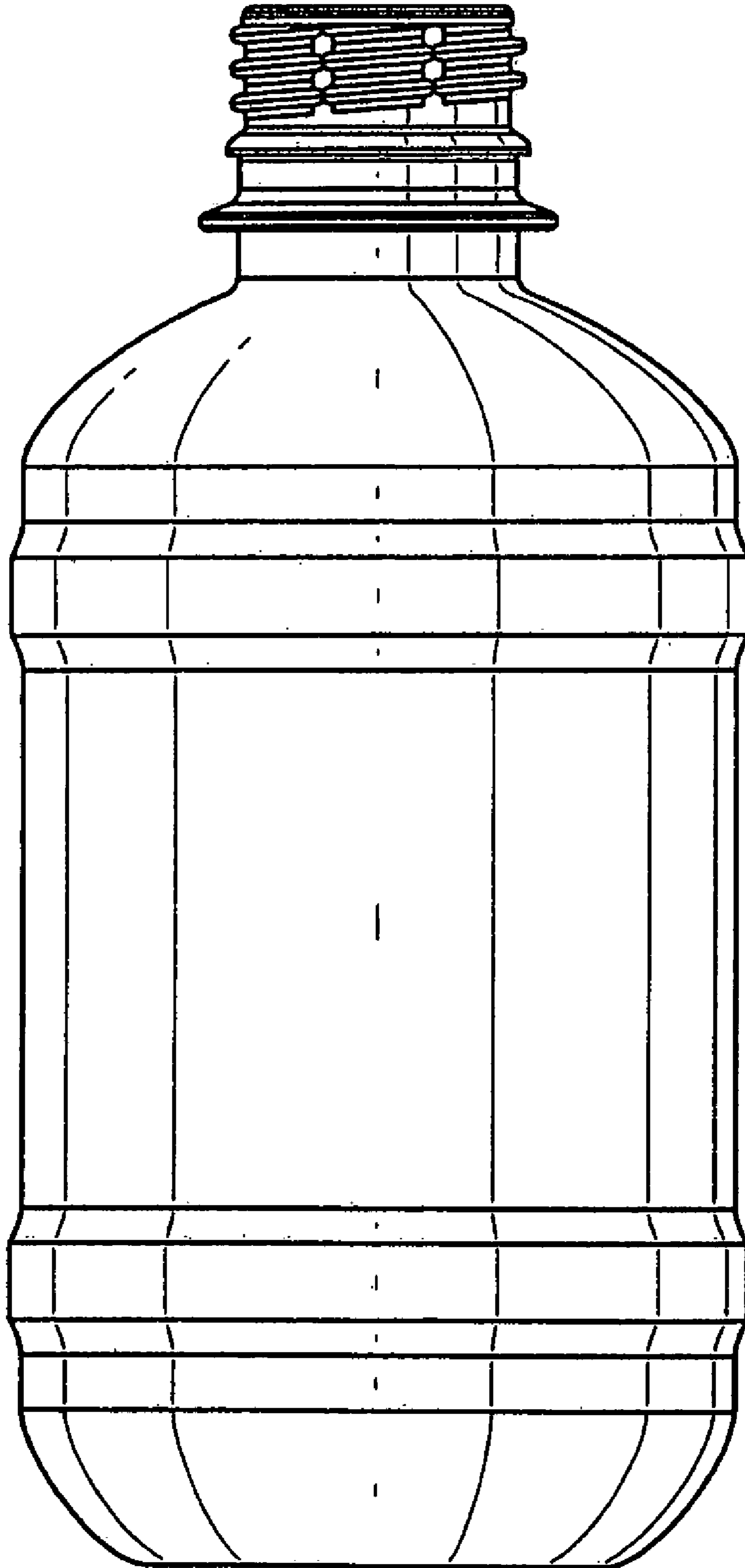

FIG. 5

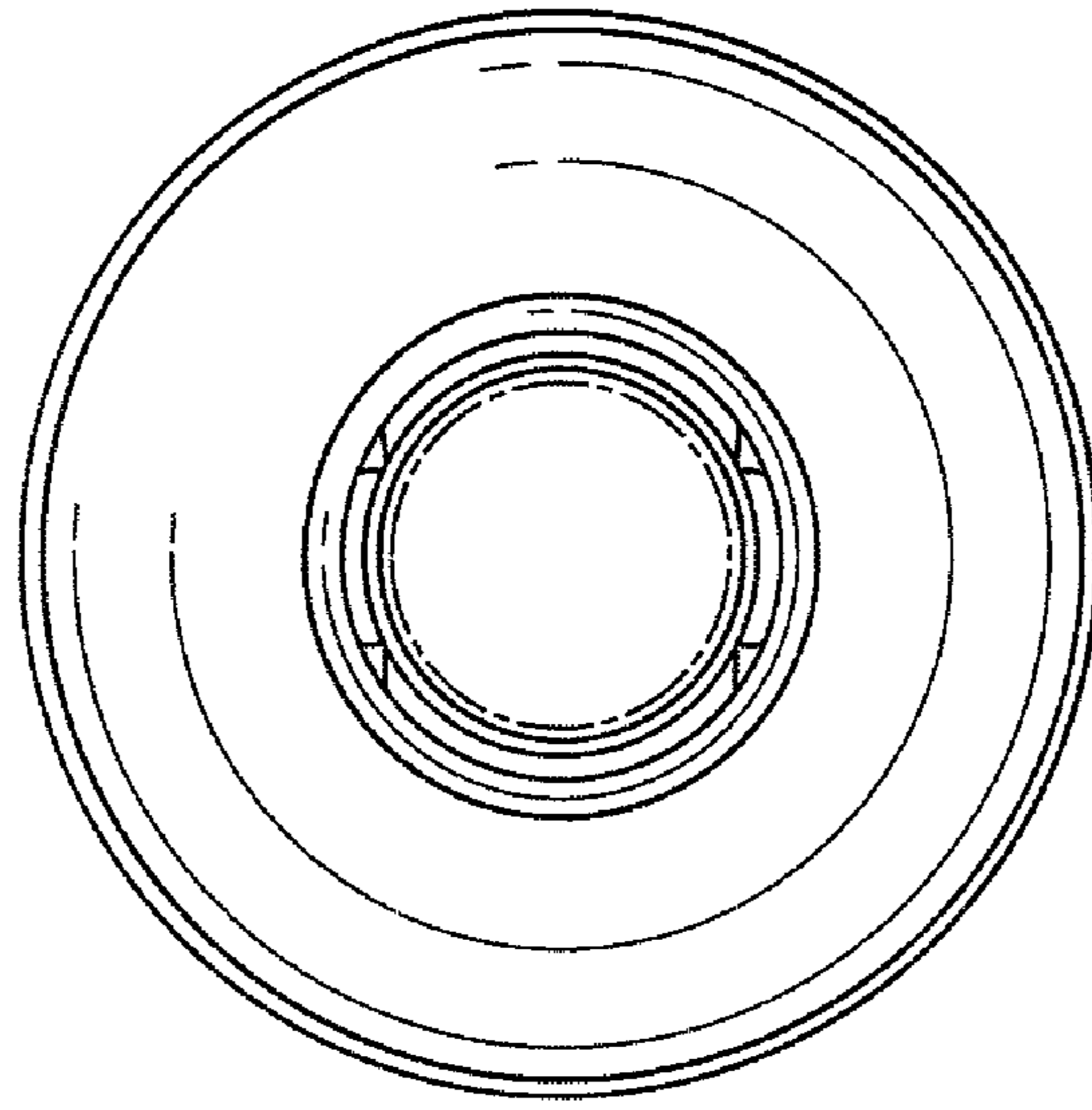

FIG. 6

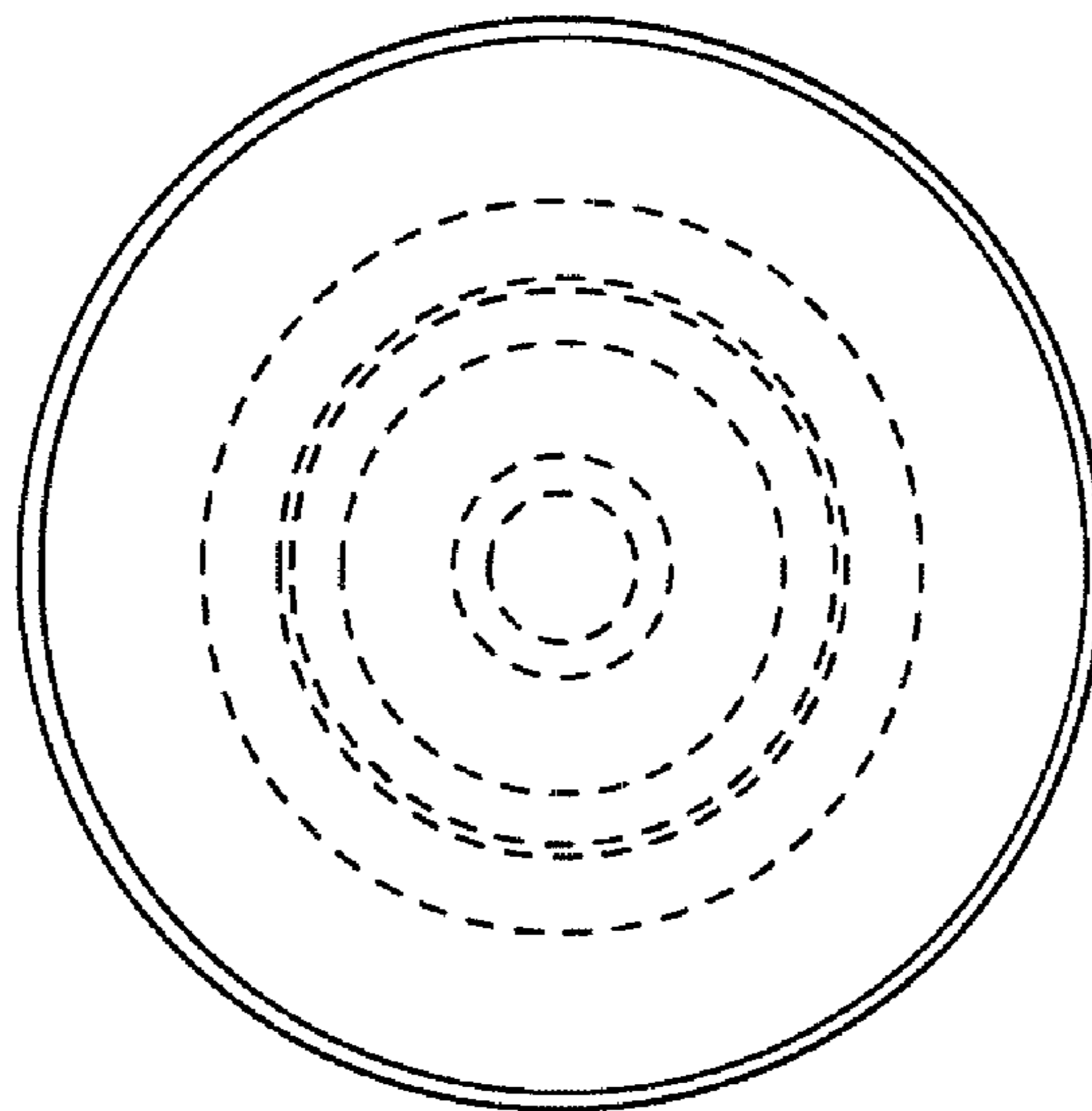

FIG. 7

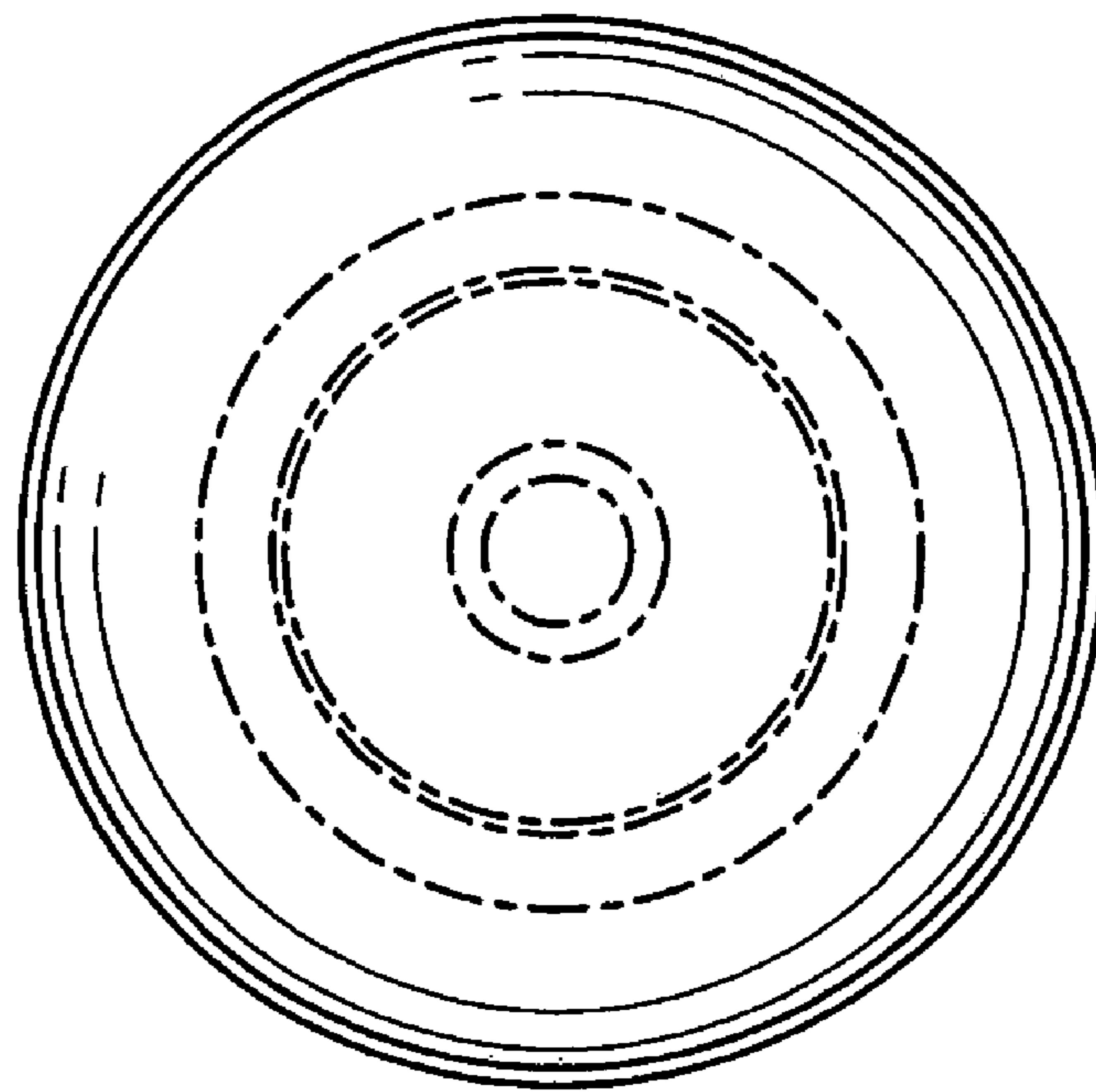

FIG. 8

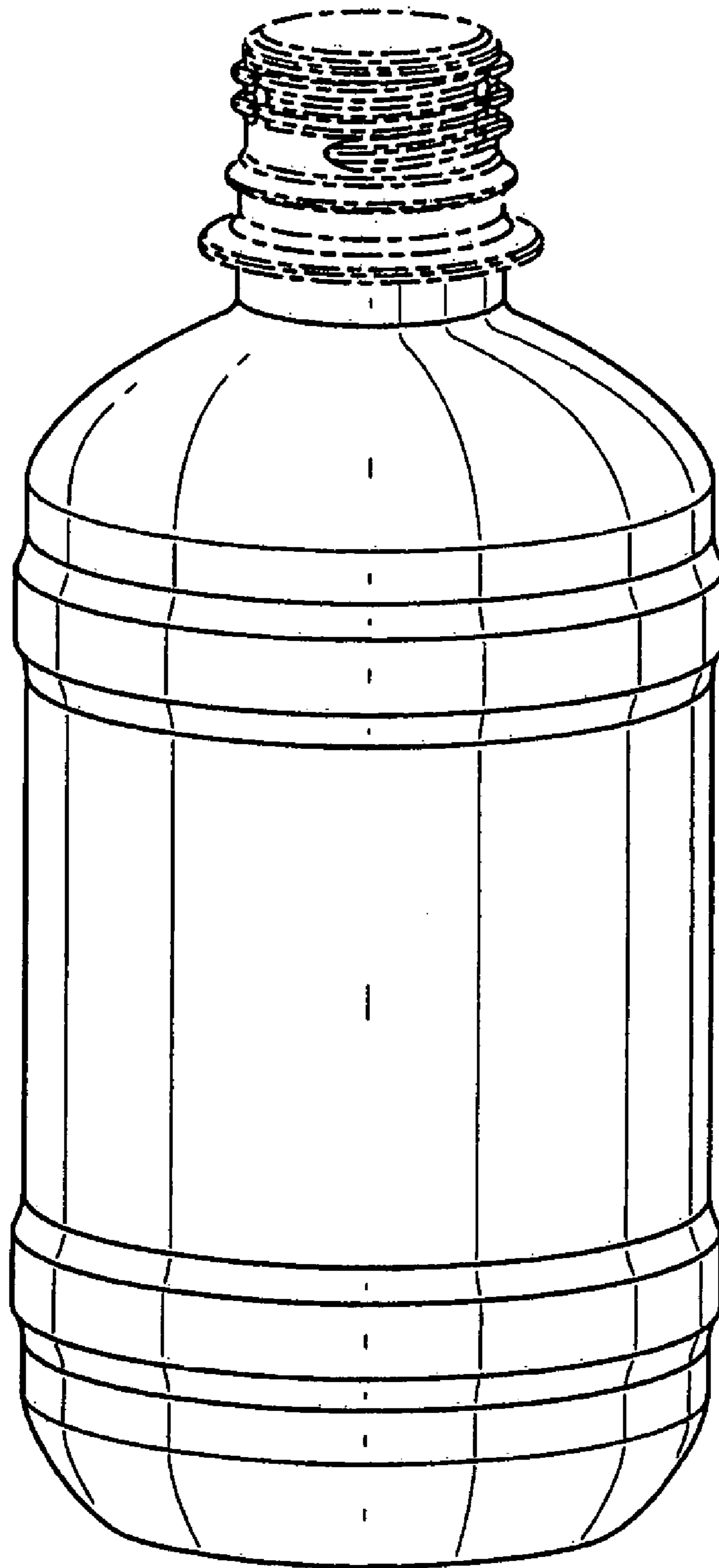

FIG. 9

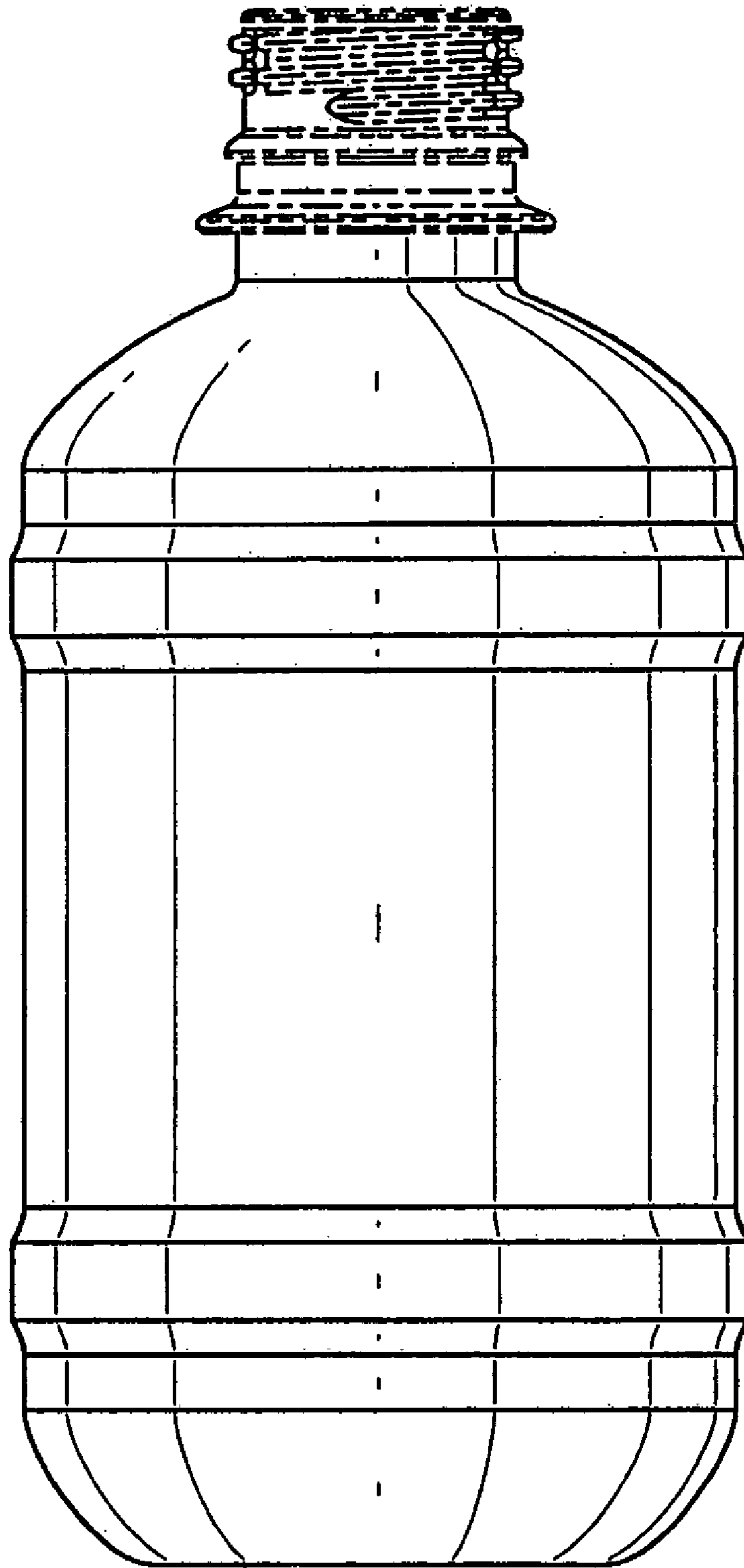

FIG. 10

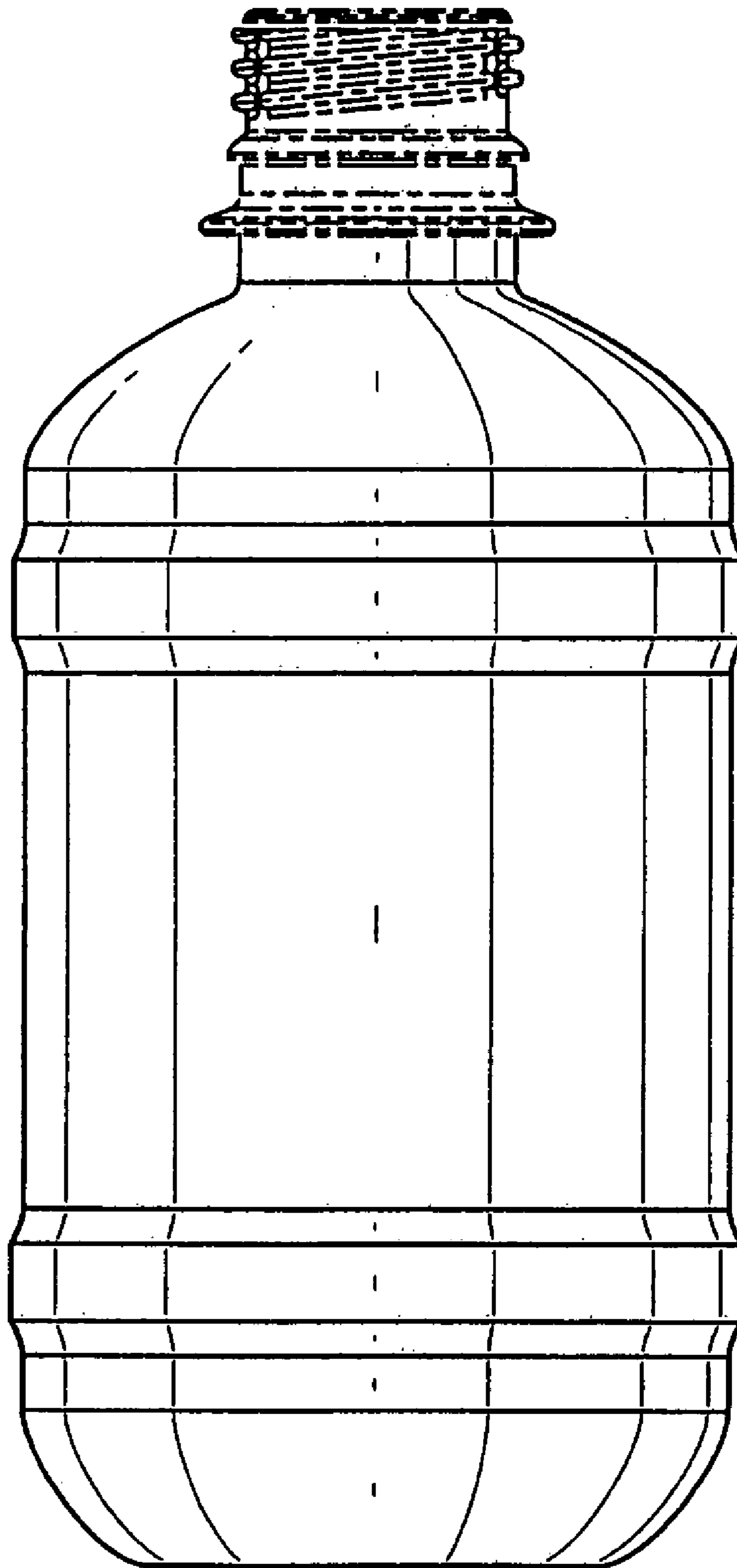

FIG. 11

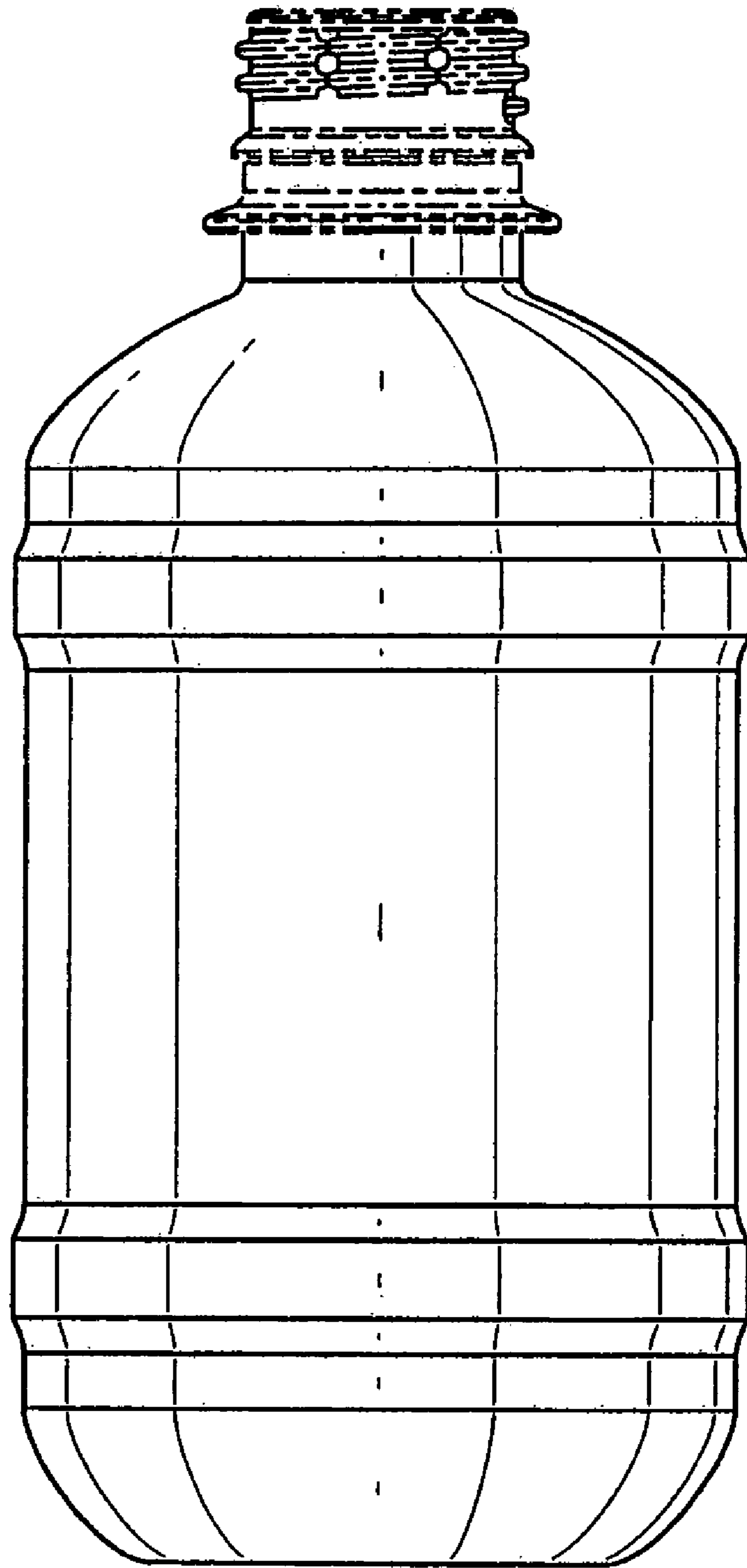

FIG. 12

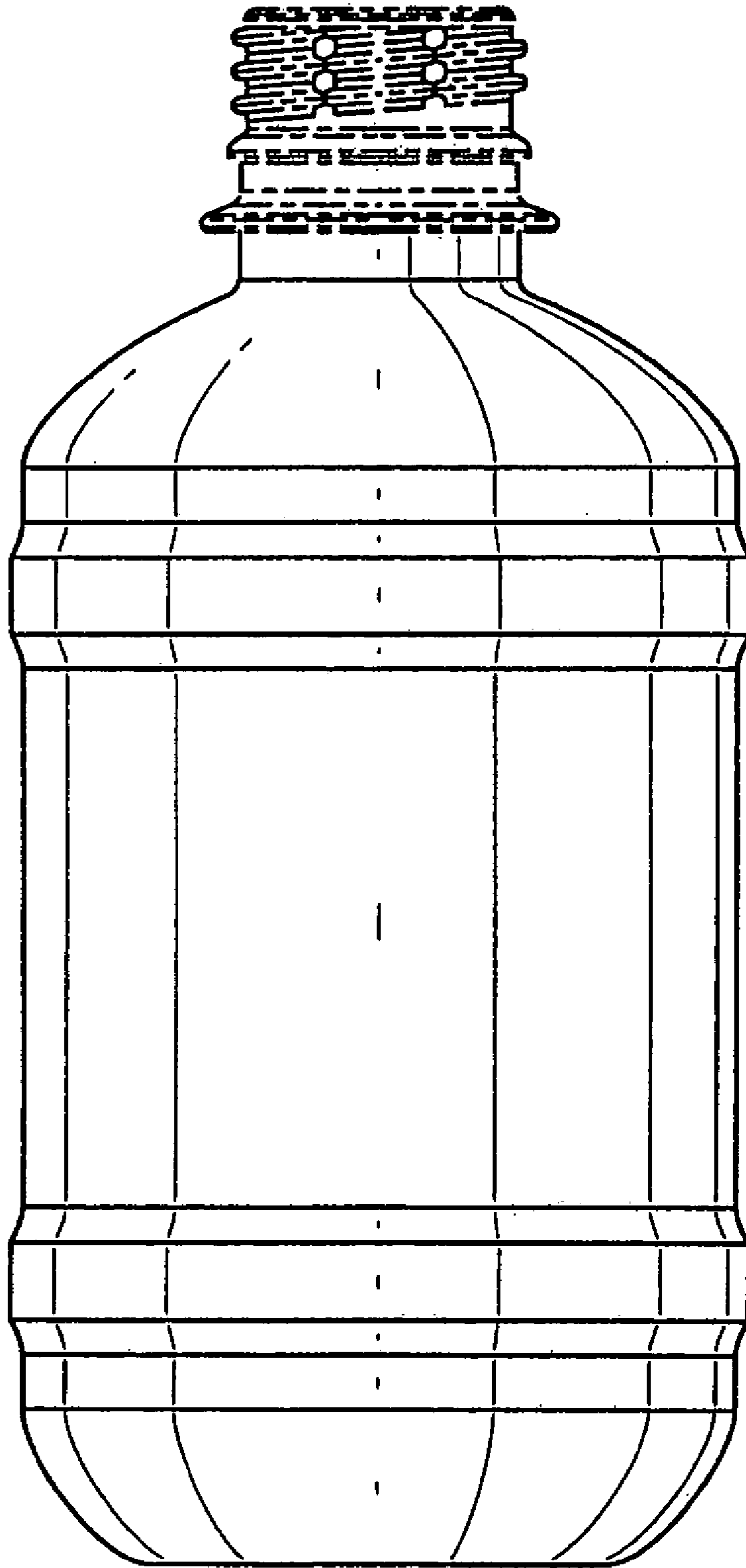

FIG. 13

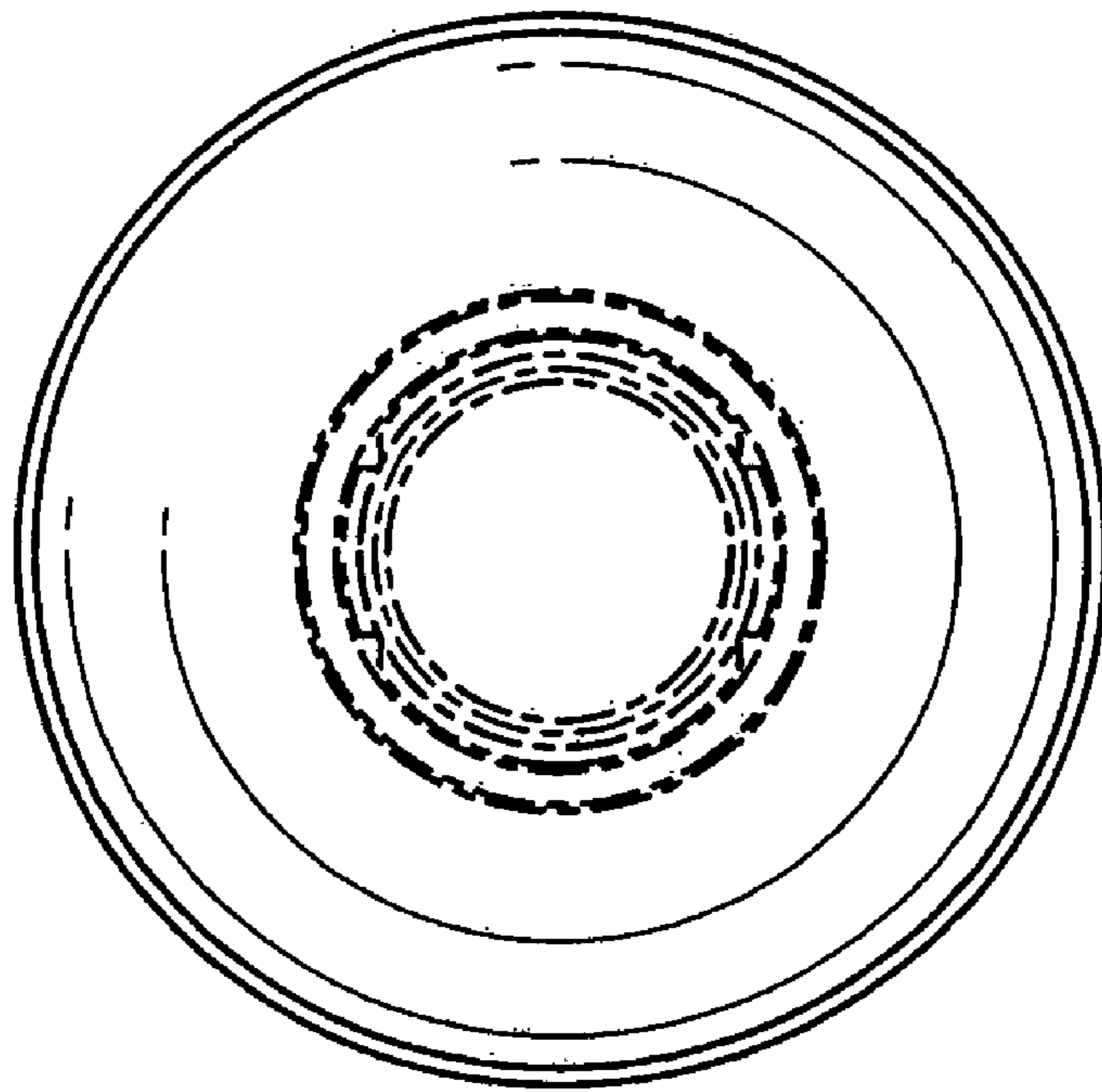

FIG. 14