



US00D581266S

(12) **United States Design Patent**
Vovan

(10) **Patent No.:** **US D581,266 S**

(45) **Date of Patent:** **** Nov. 25, 2008**

(54) **ROTISSERIE CONTAINER**

(75) Inventor: **Terry Vovan**, Upland, CA (US)

(73) Assignee: **PWP Industries**, Vernon, CA (US)

(**) Term: **14 Years**

(21) Appl. No.: **29/307,067**

(22) Filed: **Mar. 28, 2008**

(51) **LOC (8) Cl.** **09-03**

(52) **U.S. Cl.** **D9/429**

(58) **Field of Classification Search** D9/414-415,
D9/418, 423-429, 431-432, 435, 452-453,
D9/515, 761; D7/354, 504, 500, 538, 550.1,
D7/543, 545, 553.6, 554.2, 557, 565, 584-585,
D7/602, 629, 672; D3/201, 203.1-203.3,
D3/304, 307-314; 220/4.21-4.24, 23.8,
220/23.87, 266, 276, 377, 532-533, 655,
220/781-784, 790-791, 793, 835; 206/45.19,
206/45.32, 386, 425, 503, 508, 509, 511,
206/518-521, 541, 555, 558, 560, 564, 625,
206/643; 229/120, 125, 406; 426/106, 119,
426/129, 234; 219/734

See application file for complete search history.

(56) **References Cited**

U.S. PATENT DOCUMENTS

D220,682	S	*	5/1971	Artz	D9/428
D323,114	S	*	1/1992	Sheehan	D9/420
D341,316	S	*	11/1993	Fritz et al.	D9/429
5,377,860	A	*	1/1995	Littlejohn et al.	220/790
D379,431	S	*	5/1997	Mangla	D9/429
D394,807	S	*	6/1998	Krupa et al.	D9/429
D409,910	S	*	5/1999	Hayes et al.	D9/429
D410,840	S	*	6/1999	Wyslotsky et al.	D9/418
D439,160	S	*	3/2001	Abayhan et al.	D9/429
D444,382	S	*	7/2001	Hayes et al.	D9/452
D488,718	S	*	4/2004	Passerini	D9/425
6,786,351	B2	*	9/2004	Krueger	220/571

2003/0062365 A1* 4/2003 Krueger 220/4.24
2008/0116098 A1* 5/2008 Maroofan et al. 206/503

* cited by examiner

Primary Examiner—Robert M Spear

Assistant Examiner—Susan E Krakower

(74) *Attorney, Agent, or Firm*—Leon D. Rosen

(57) **CLAIM**

The ornamental design for rotisserie container, as shown and described.

DESCRIPTION

FIG. 1 is a top isometric view of a rotisserie container in a closed position.

FIG. 2 is a plan view of the closed container of FIG. 1.

FIG. 3 is a bottom view of the closed container of FIG. 1.

FIG. 4 is a front elevational view of the closed container of FIG. 1.

FIG. 5 is a left side elevation view of the closed container of FIG. 1.

FIG. 6 is an isometric view of only the cover of the container of FIG. 1.

FIG. 7 is a plan view of the cover of FIG. 6.

FIG. 8 is a front elevation view of the cover of FIG. 6.

FIG. 9 is a left side elevation view of the cover of FIG. 6.

FIG. 10 is a top isometric view of the view of the base of the container of FIG. 1.

FIG. 11 is a plan view of the base of FIG. 10.

FIG. 12 is a bottom view of the base of FIG. 10.

FIG. 13 is a front elevation view of the base of FIG. 10.

FIG. 14 is a left side elevation view of the base of FIG. 10; and,

FIG. 15 is a bottom view of the cover of the cover of FIG. 6.

1 Claim, 15 Drawing Sheets

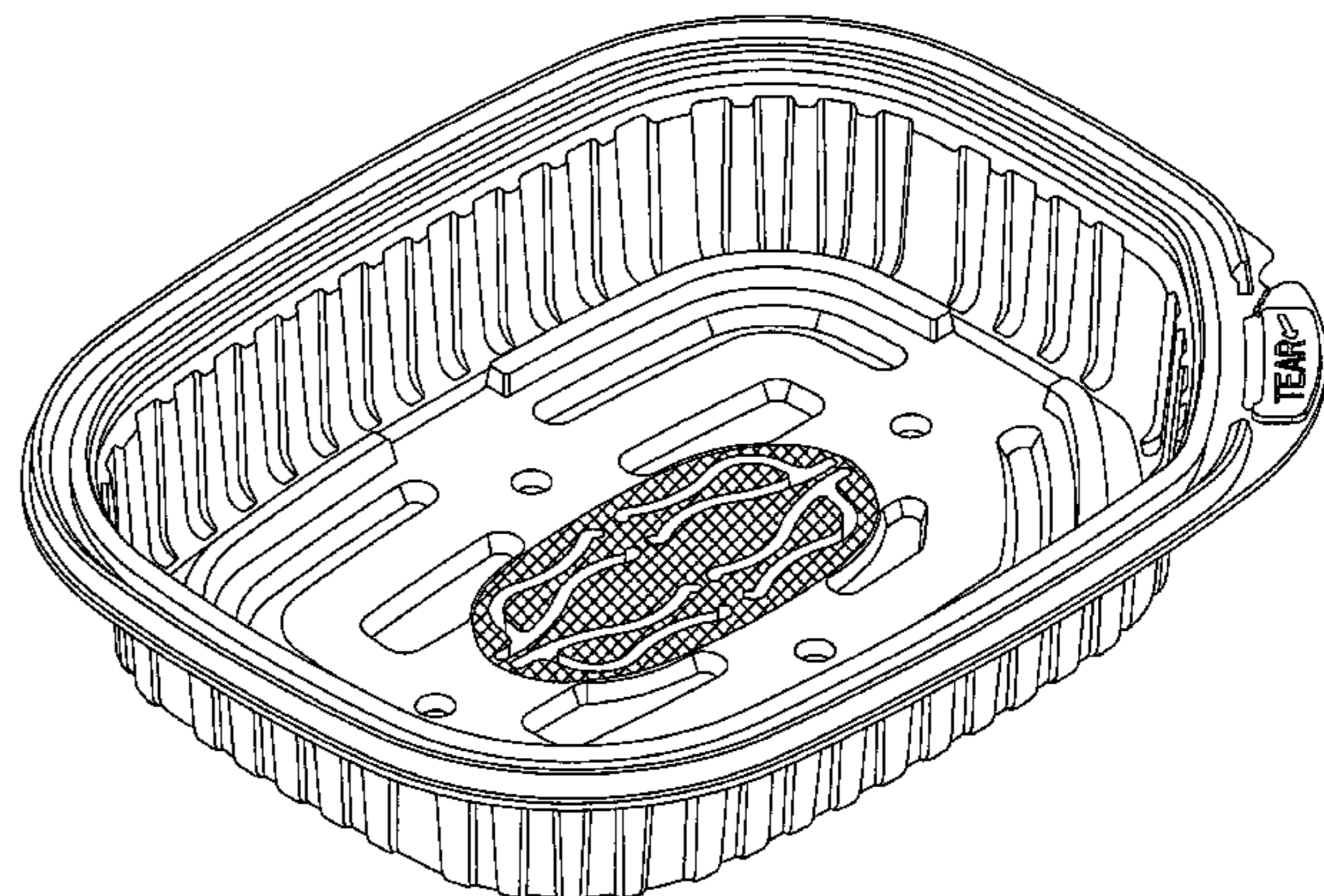
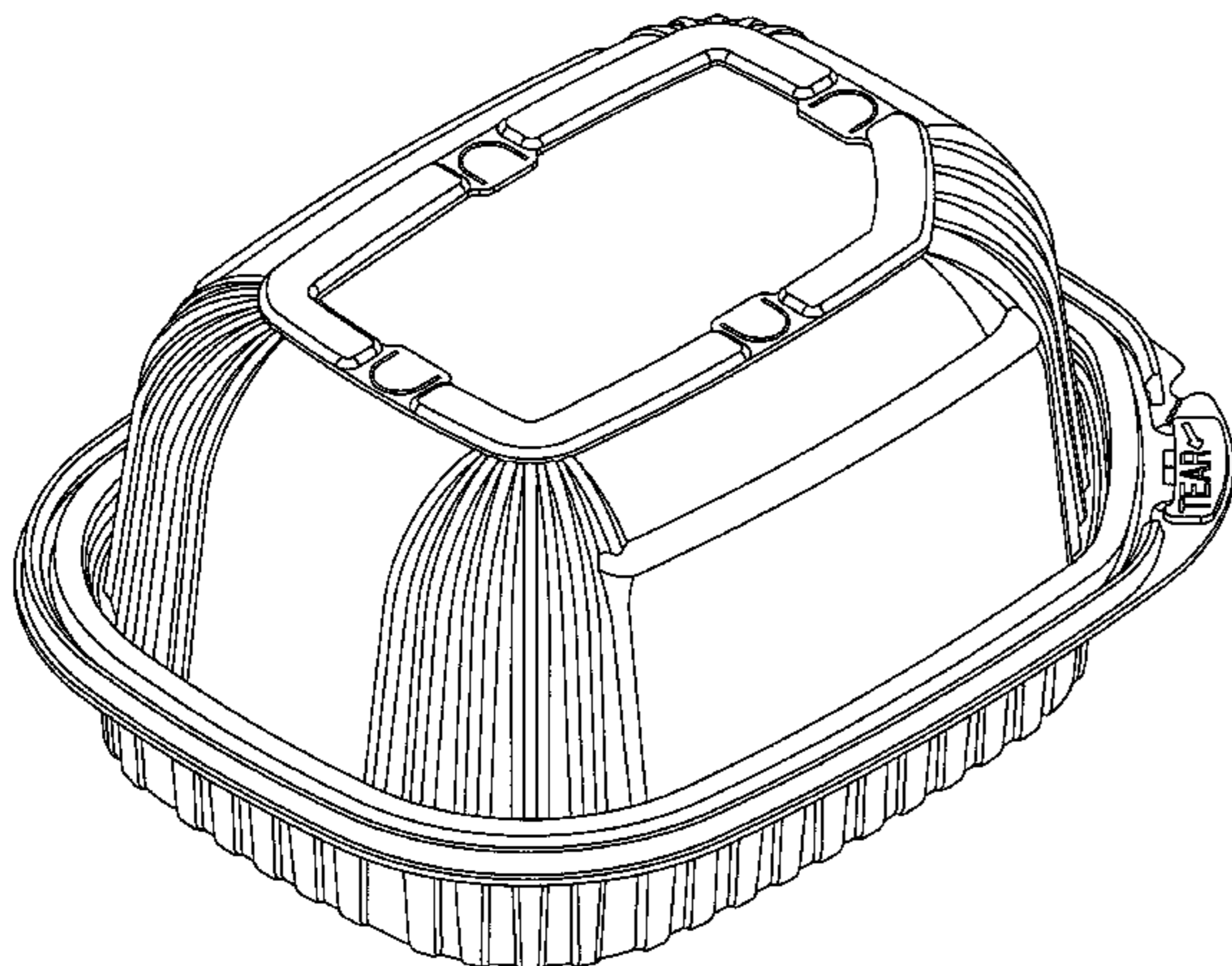

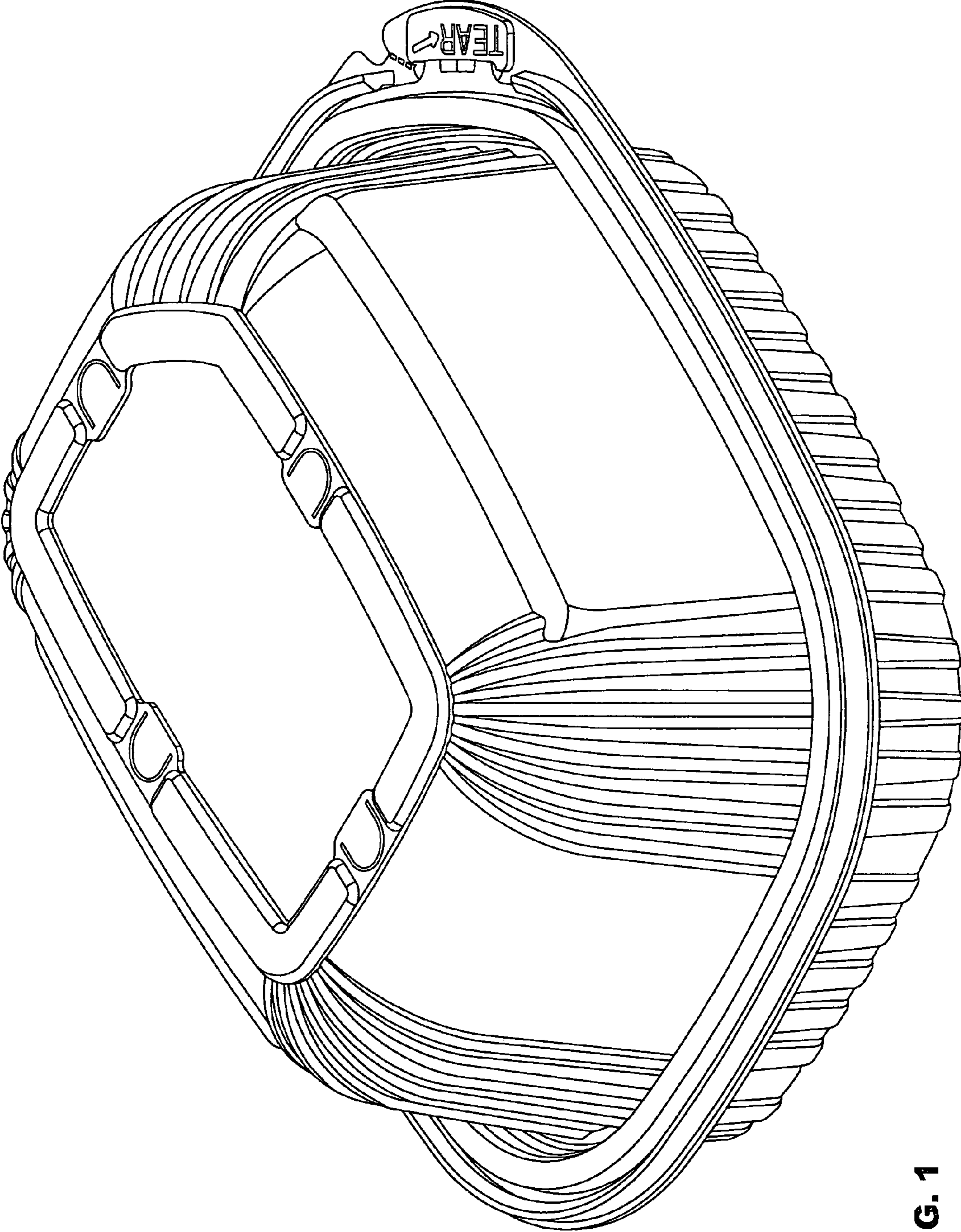

FIG. 1

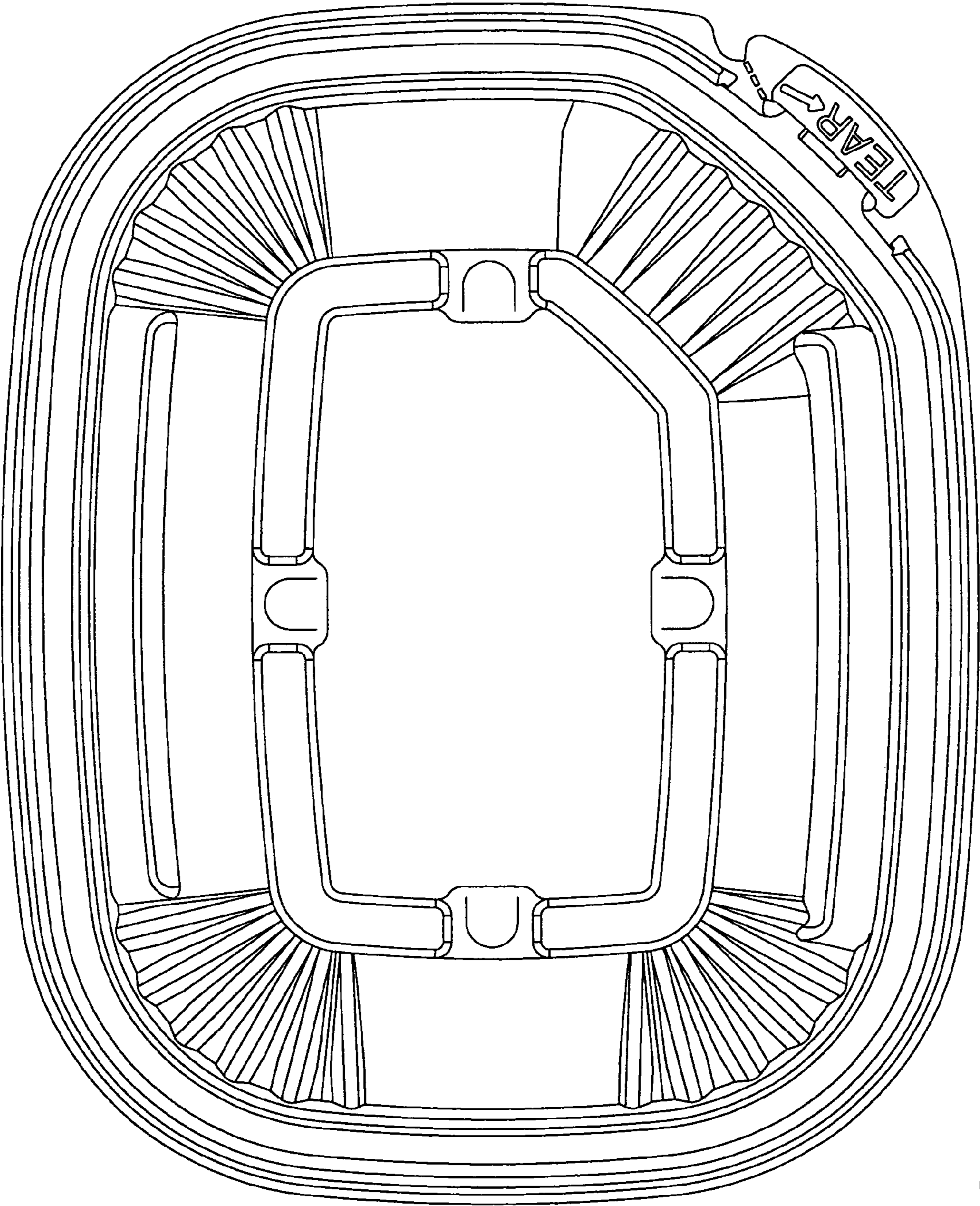

FIG. 2

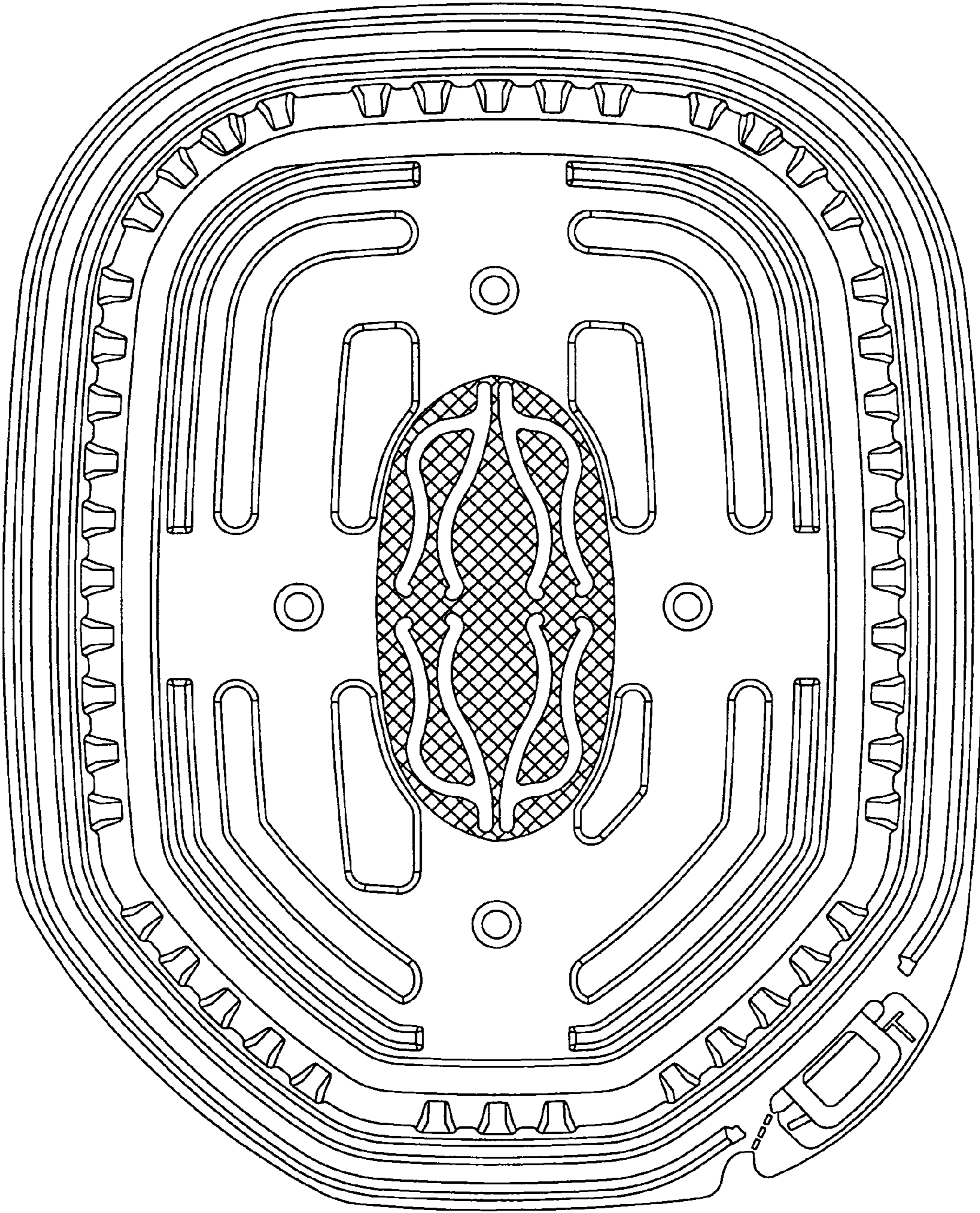

FIG. 3

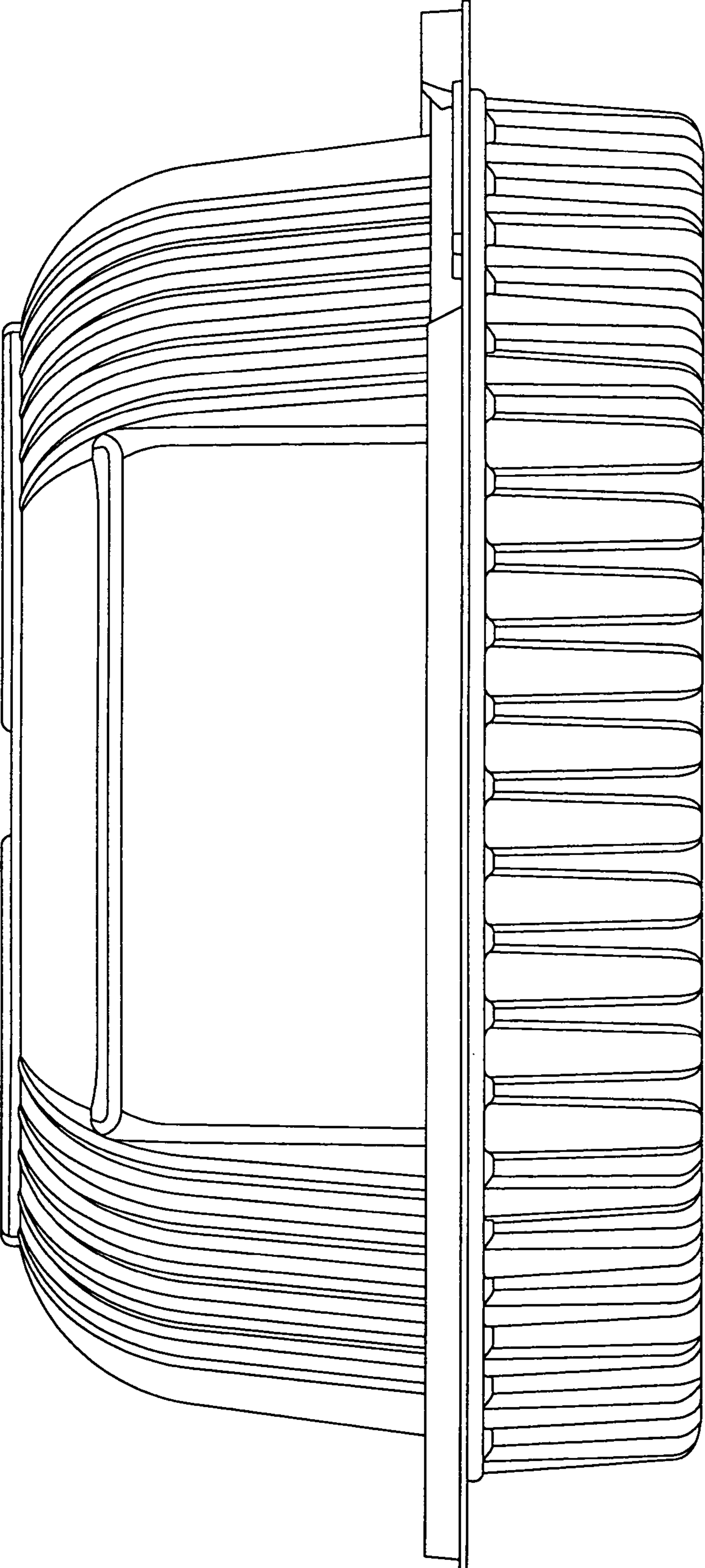

FIG. 4

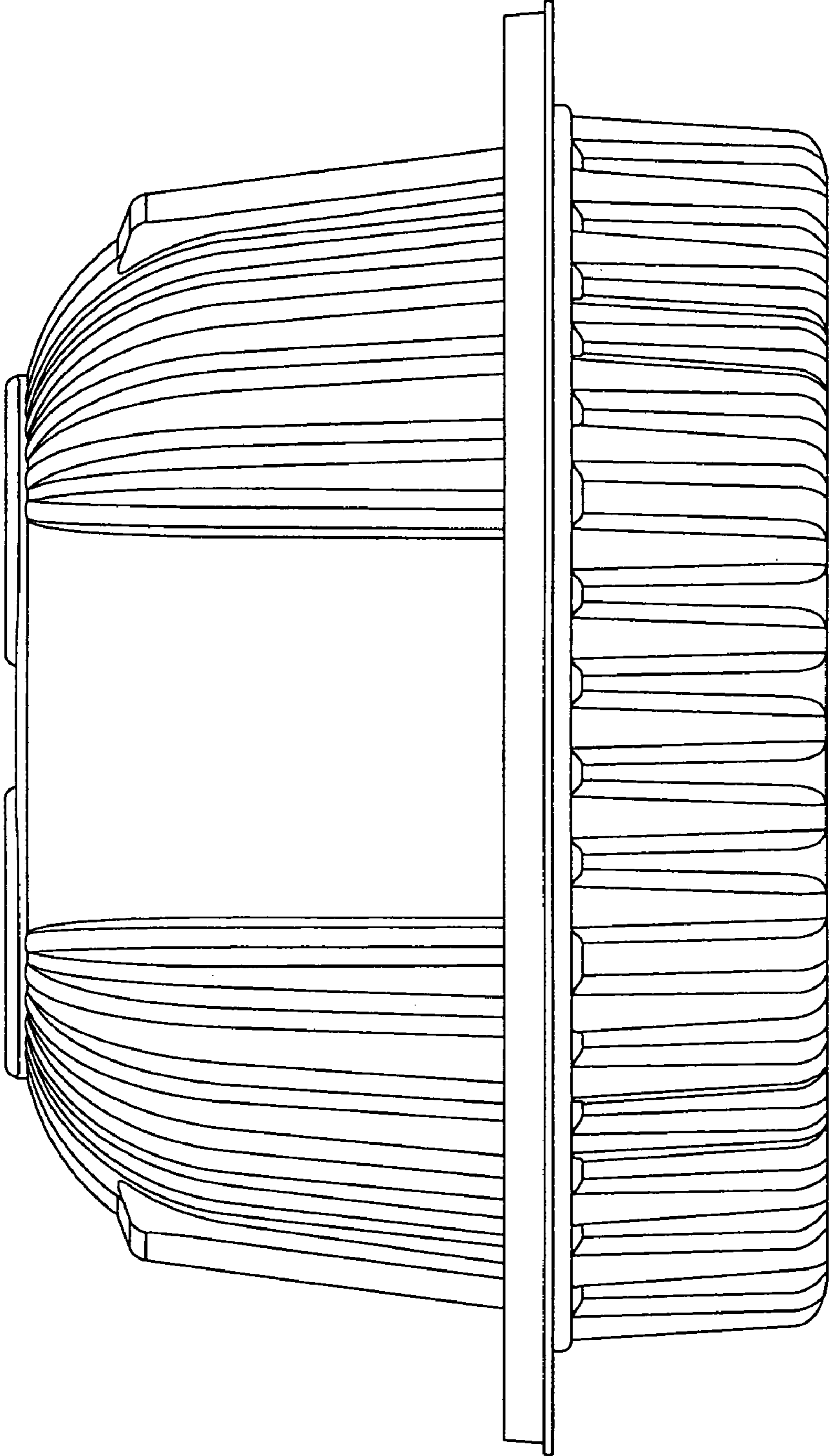

FIG. 5

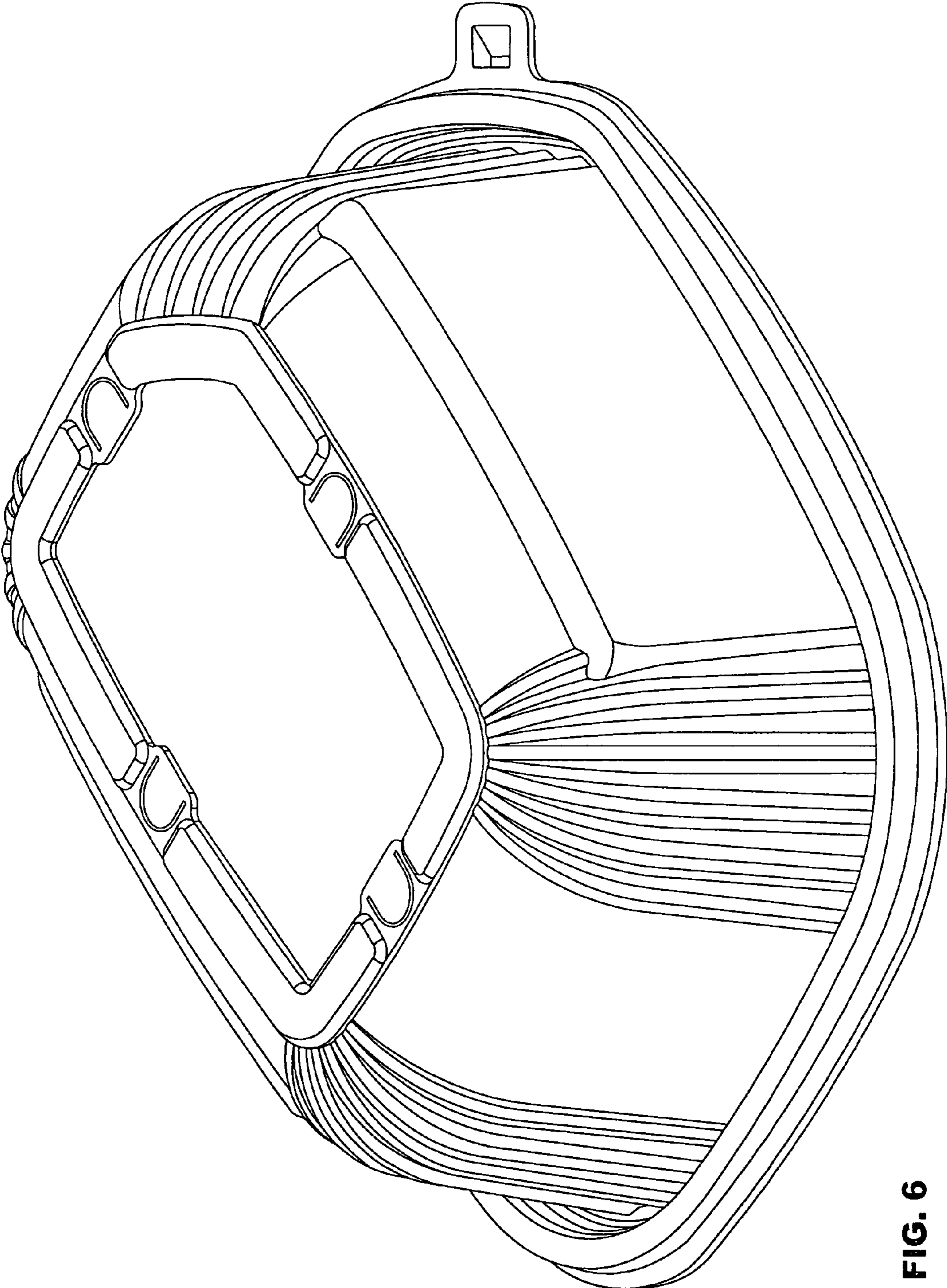

FIG. 6

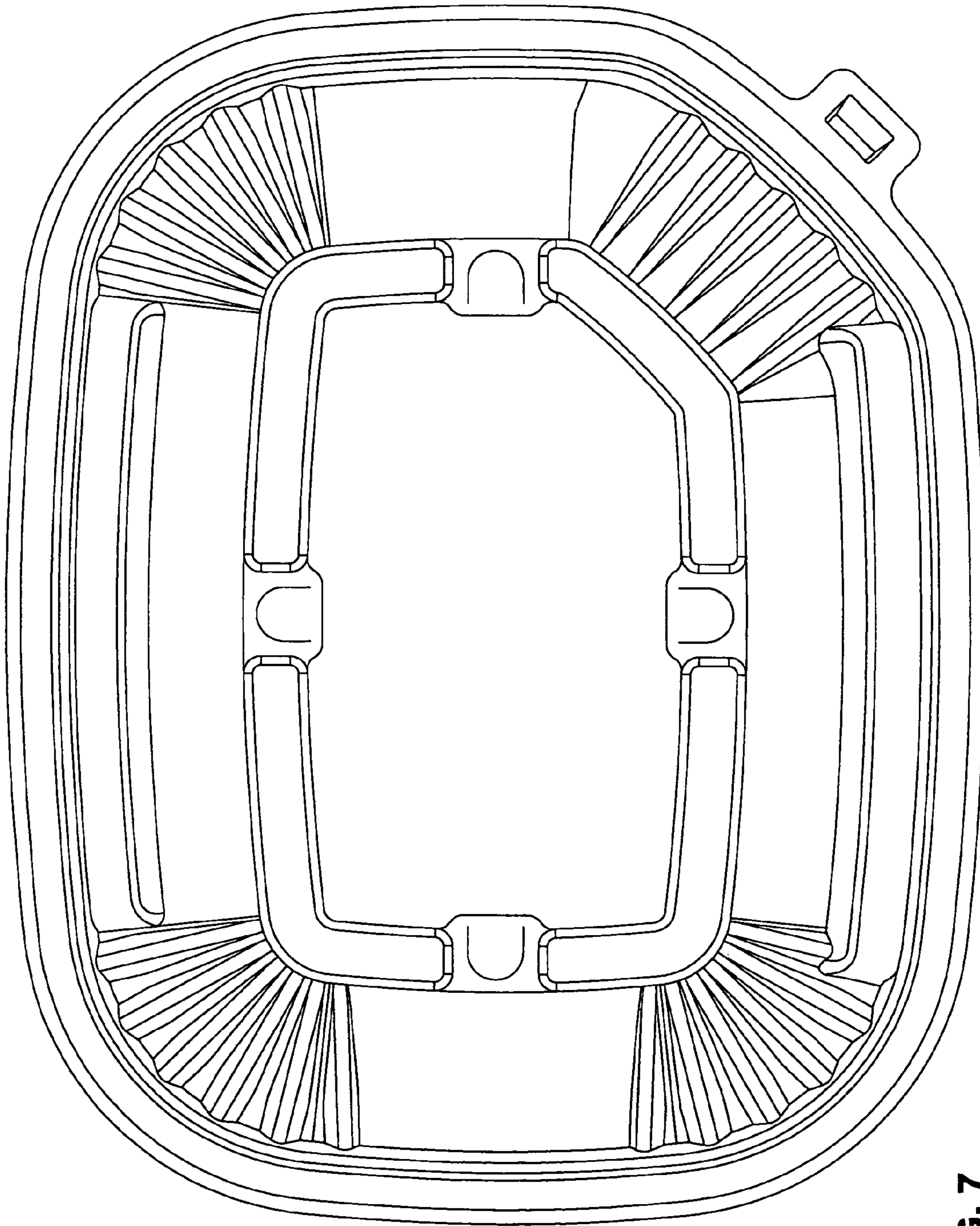

FIG. 7

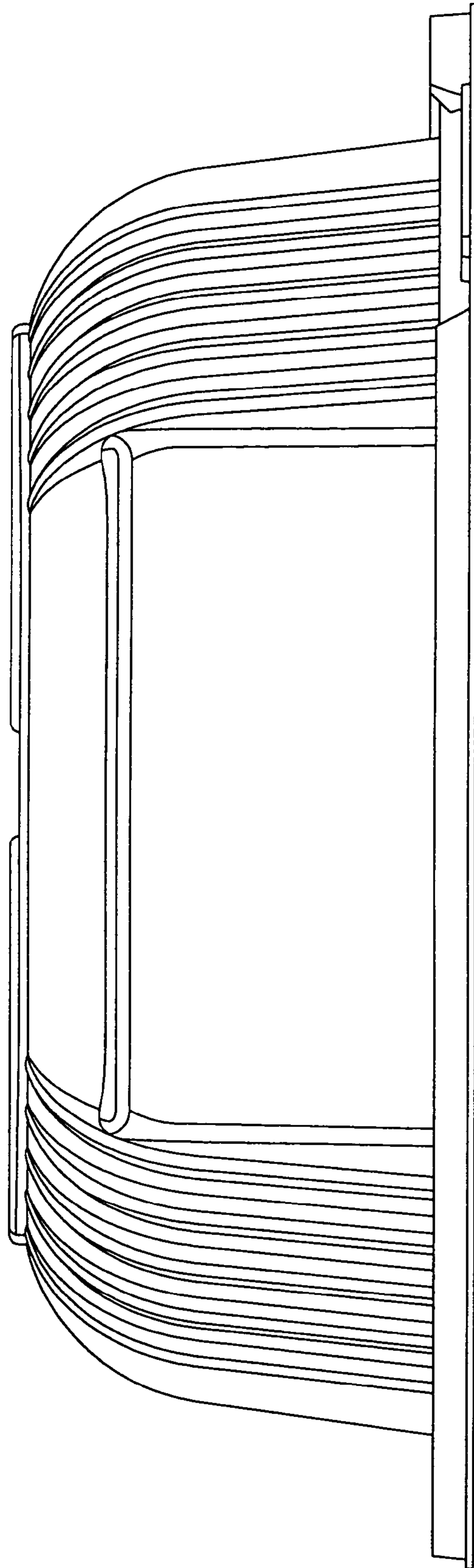

FIG. 8

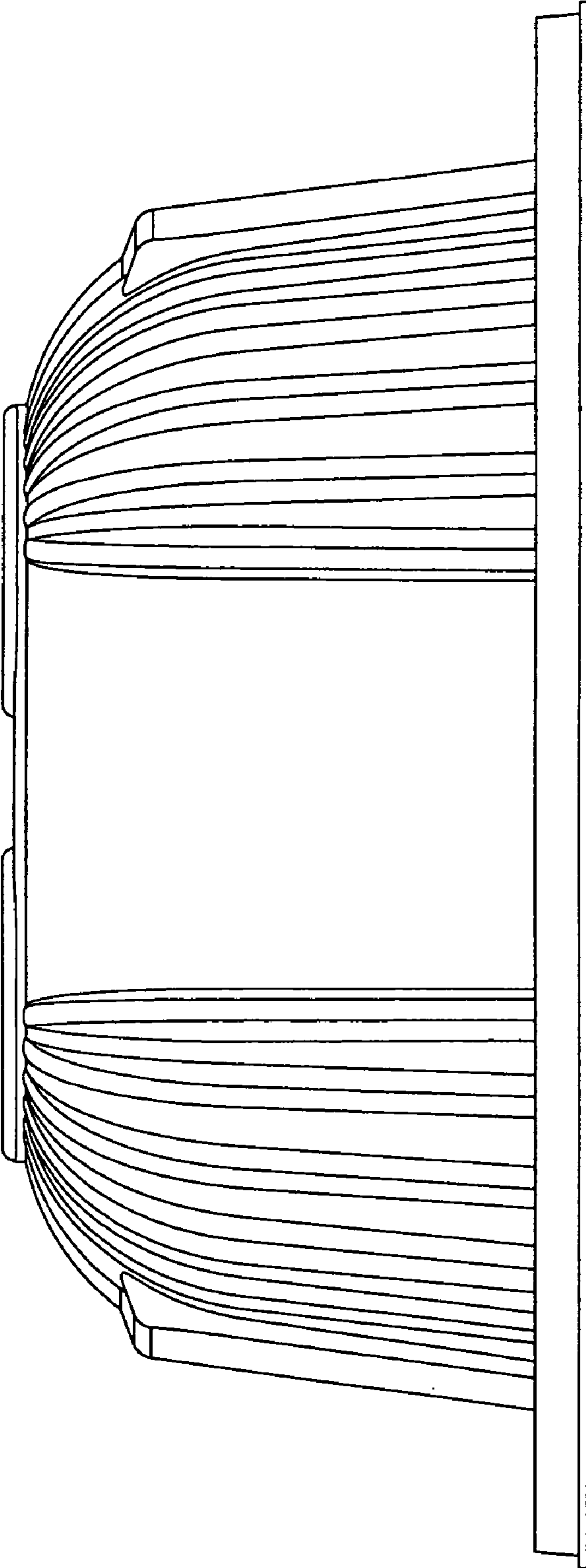

FIG. 9

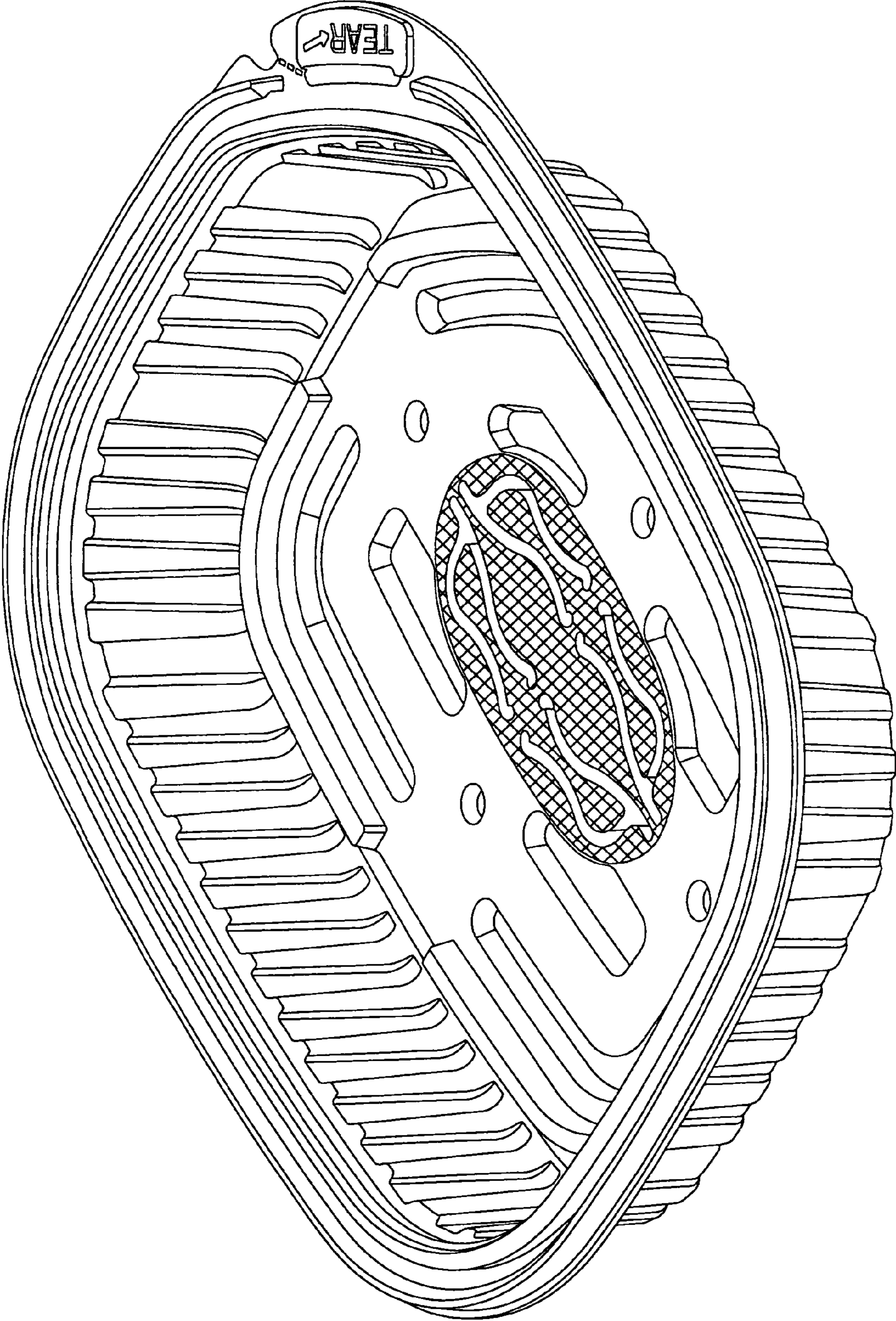

FIG. 10

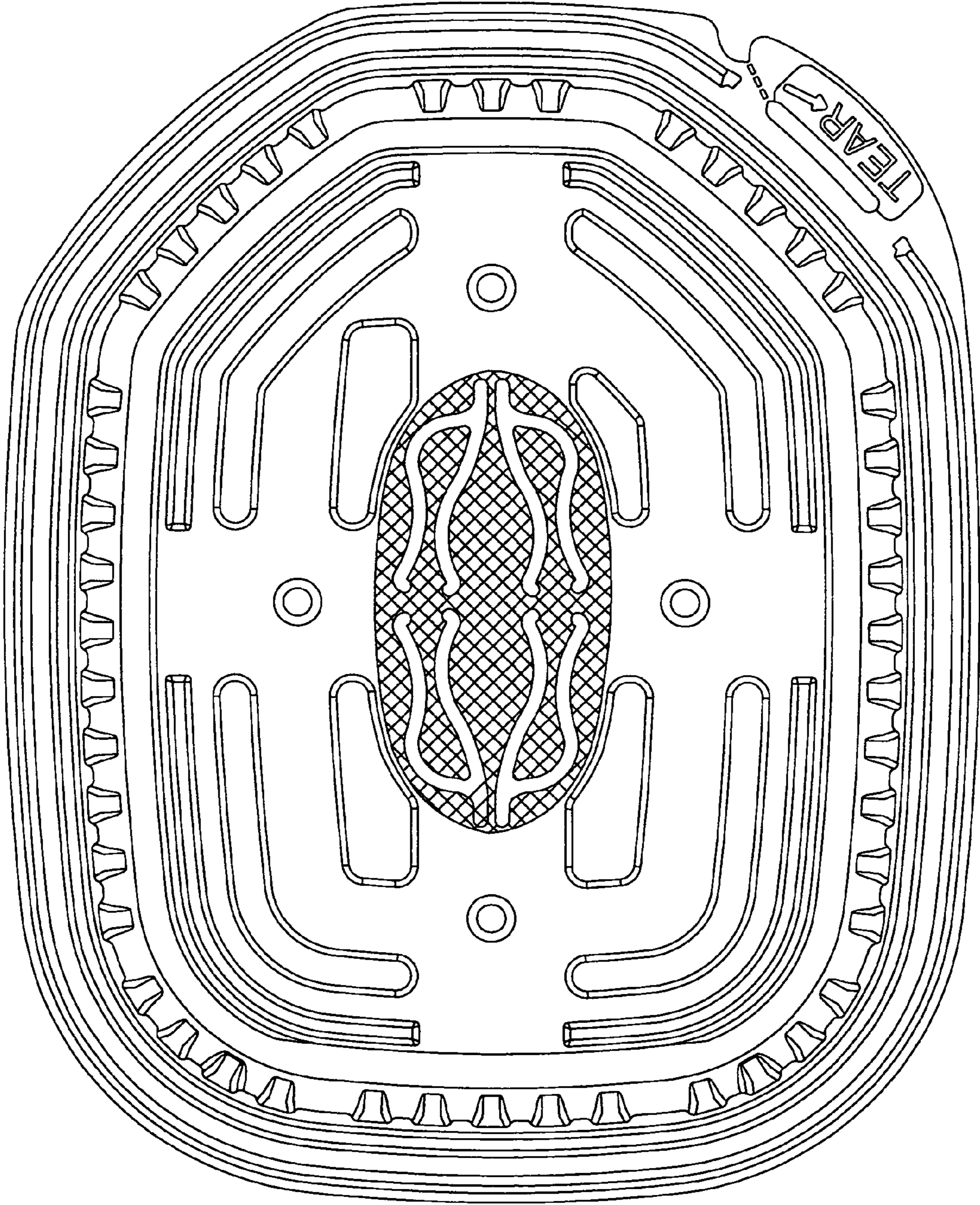

FIG. 11

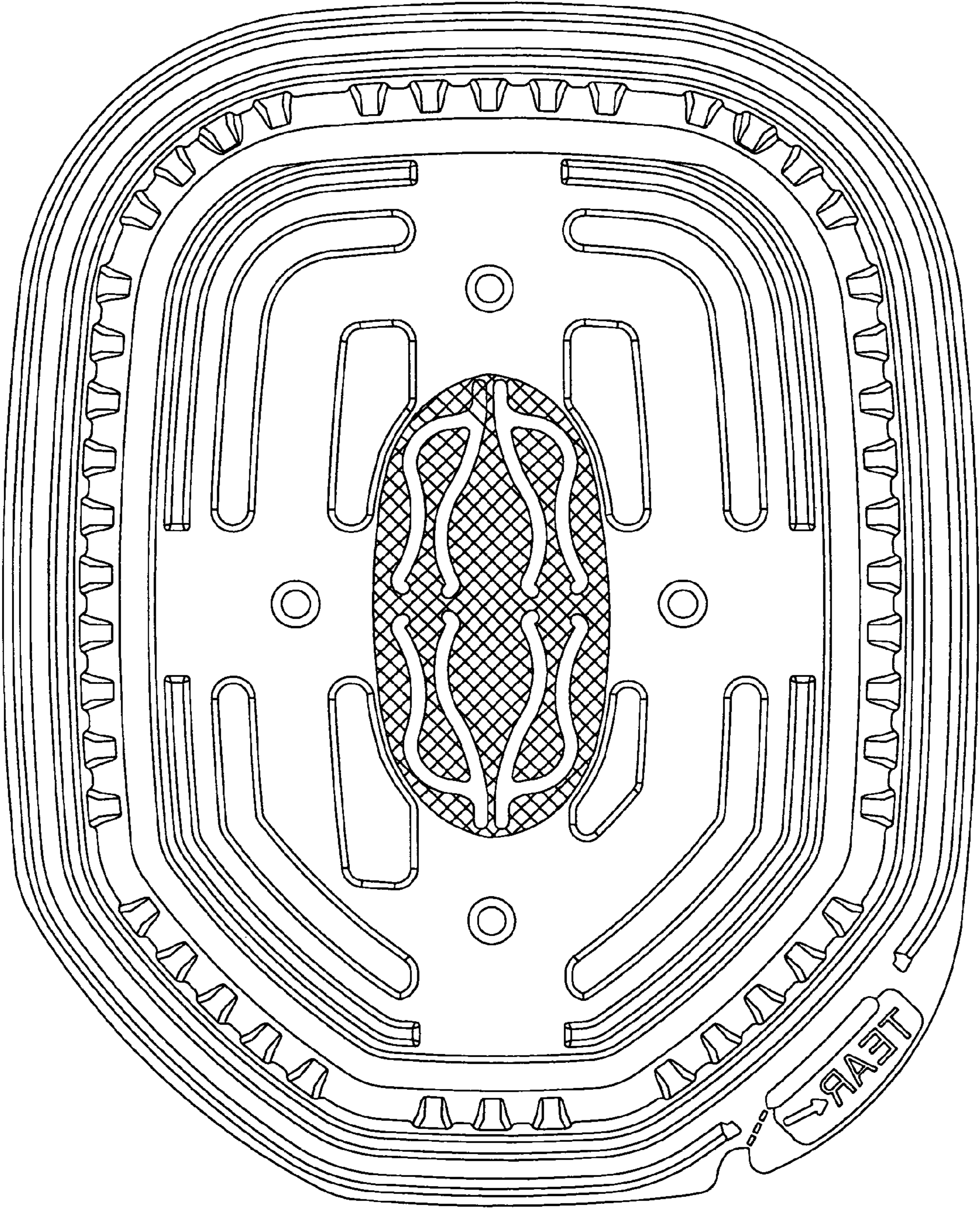

FIG. 12

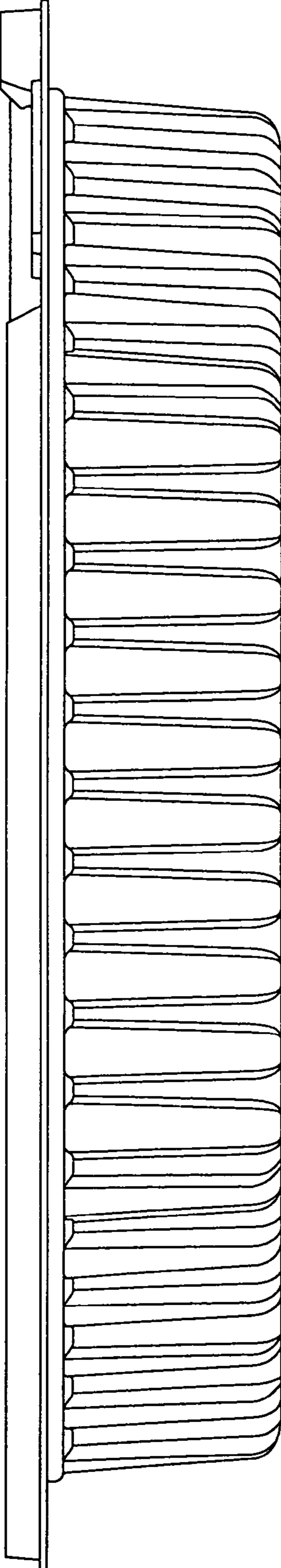

FIG. 13

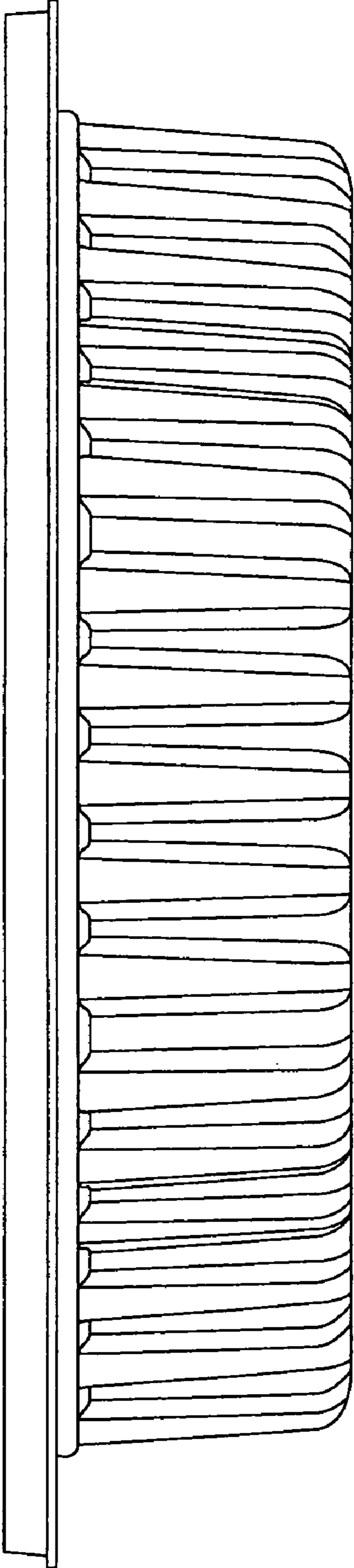

FIG. 14

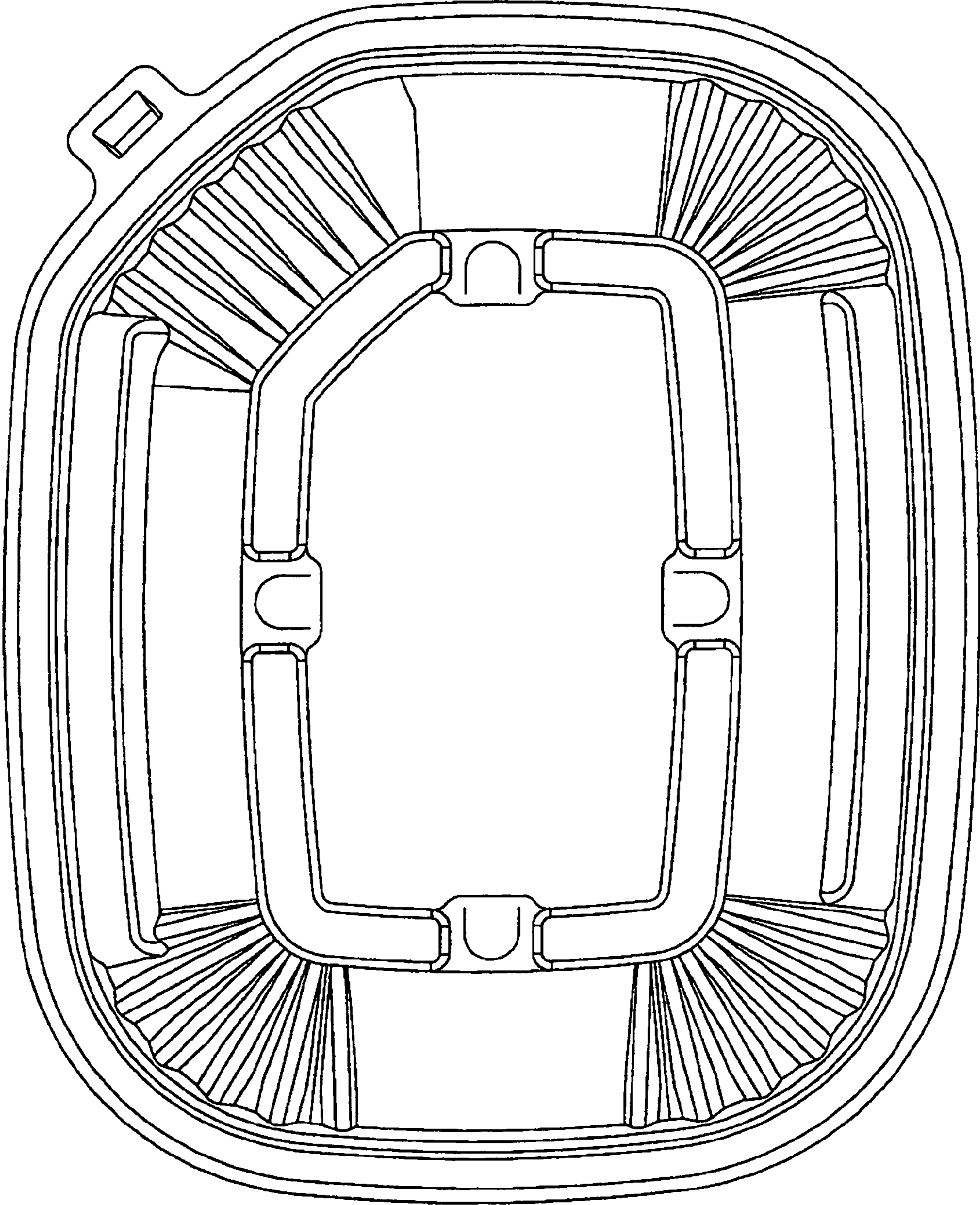

FIG. 15