



US00D581104S

(12) **United States Design Patent**
Fang

(10) **Patent No.:** **US D581,104 S**

(45) **Date of Patent:** **** Nov. 18, 2008**

(54) **HATBAND**

(76) **Inventor:** **Kenneth Fang**, P.O. Box 26-757, Taipei
106 (TW)

(**) **Term:** **14 Years**

(21) **Appl. No.:** **29/286,951**

(22) **Filed:** **May 24, 2007**

(51) **LOC (8) Cl.** **07-02**

(52) **U.S. Cl.** **D29/122**

(58) **Field of Classification Search** D29/102-107,
D29/122; 2/410-412, 414, 416-425, 5, 6.6-6.8,
2/452, DIG. 11, 8.1, 9, 10; 128/201.22, 207.17;
D26/51; 362/105-107

See application file for complete search history.

(56) **References Cited**

U.S. PATENT DOCUMENTS

- D501,956 S * 2/2005 Grepper et al. D29/122
- D503,499 S * 3/2005 Howard et al. D29/122
- 7,000,262 B2 * 2/2006 Bielefeld 2/418

- 7,120,939 B1 * 10/2006 Howard et al. 2/416
- 2001/0037519 A1 * 11/2001 Paris et al. 2/422
- 2008/0109947 A1 * 5/2008 Dubois 2/414

* cited by examiner

Primary Examiner—Ruth McInroy

(74) *Attorney, Agent, or Firm*—Rosenberg, Klein & Lee

(57) **CLAIM**

The ornamental design for a hatband, as shown and described.

DESCRIPTION

FIG. 1 is a perspective view of a hatband showing my new design;
 FIG. 2 is a front view thereof;
 FIG. 3 is a rear view thereof;
 FIG. 4 is a left side view thereof;
 FIG. 5 is a right side view thereof;
 FIG. 6 is a top view thereof; and,
 FIG. 7 is a bottom view thereof.

1 Claim, 4 Drawing Sheets

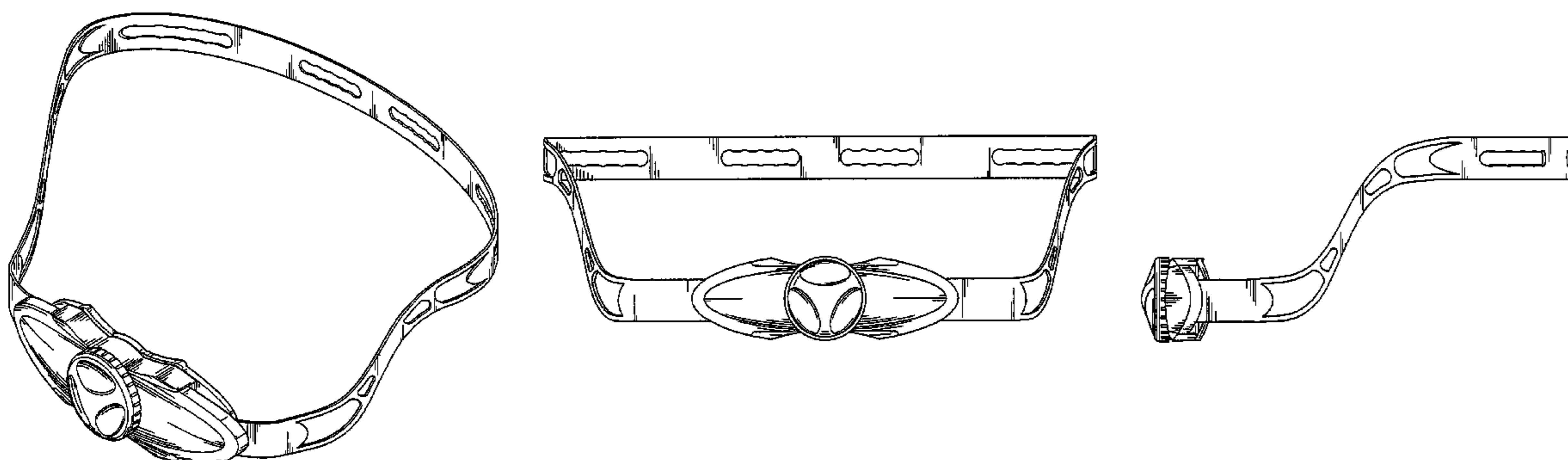

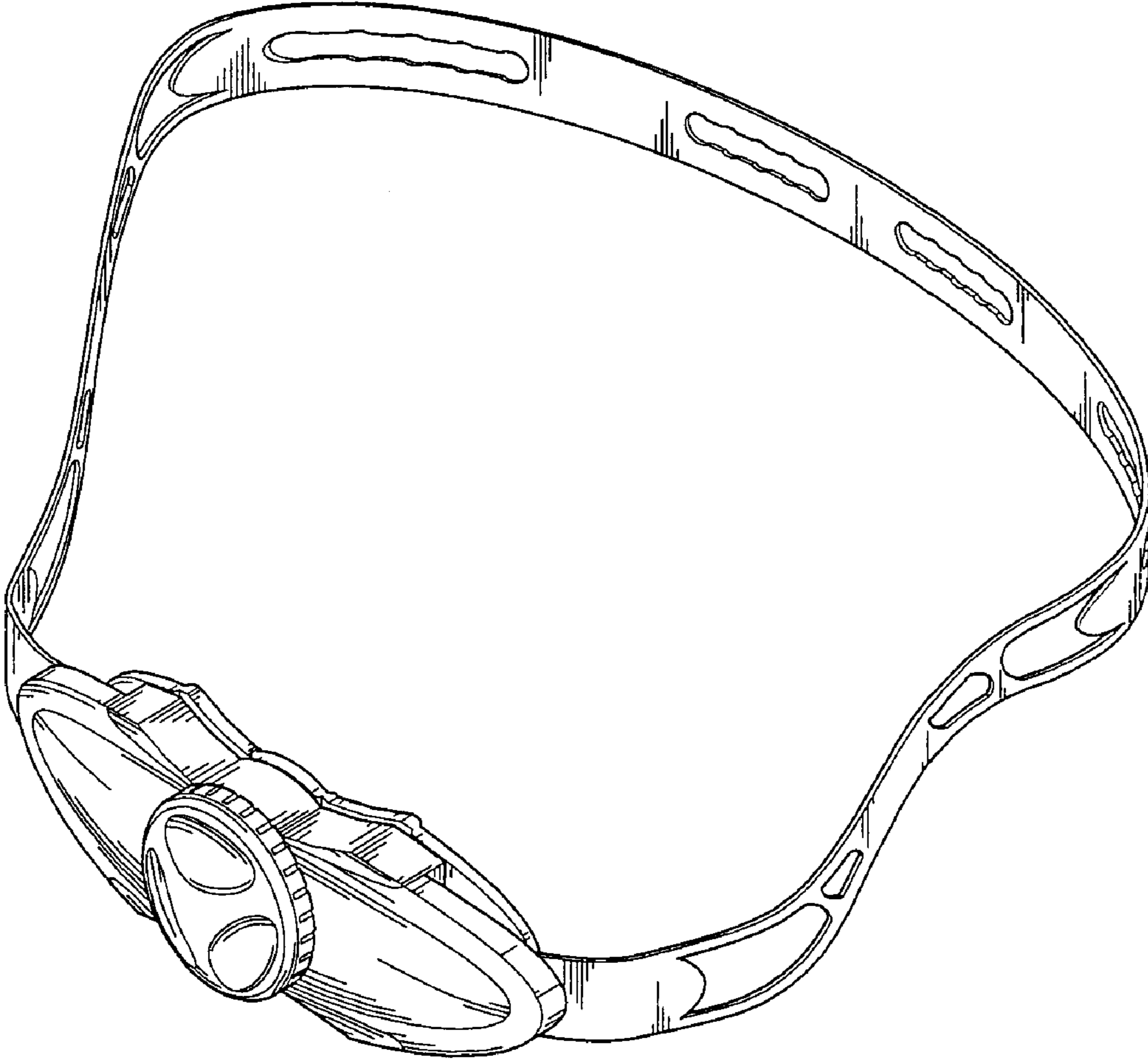

FIG. 1

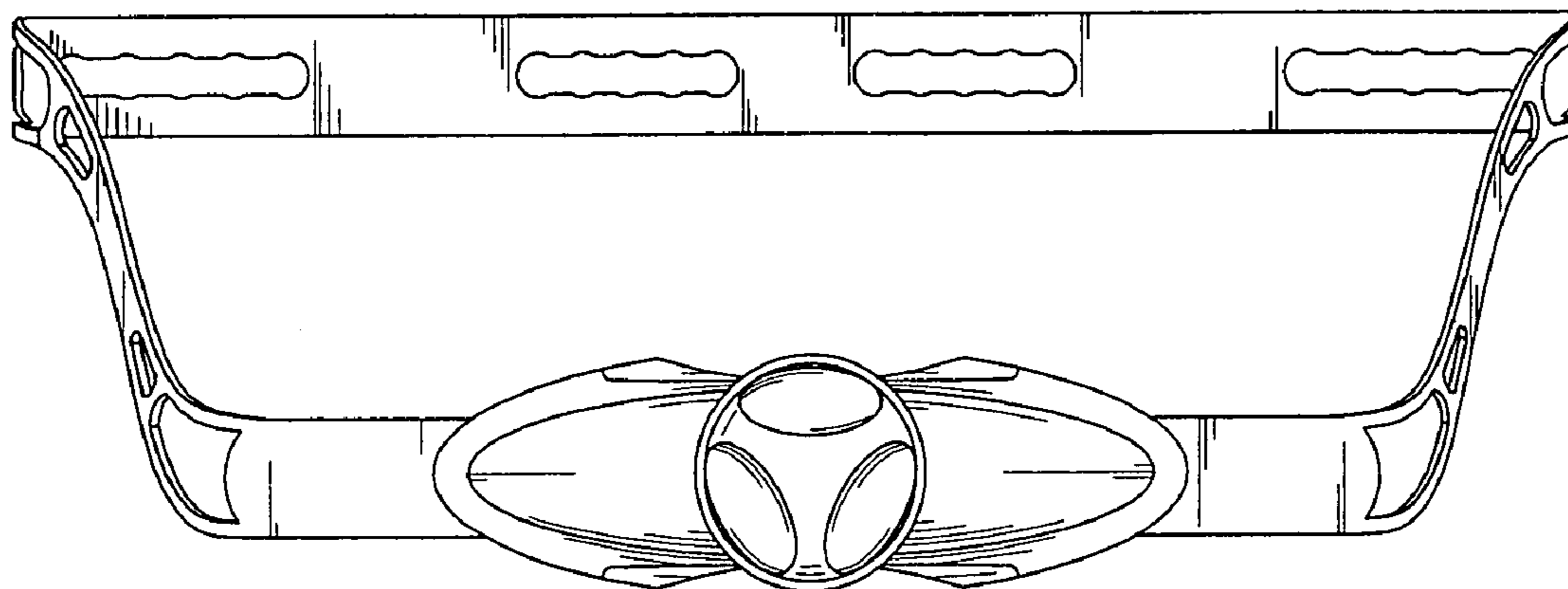

FIG. 2

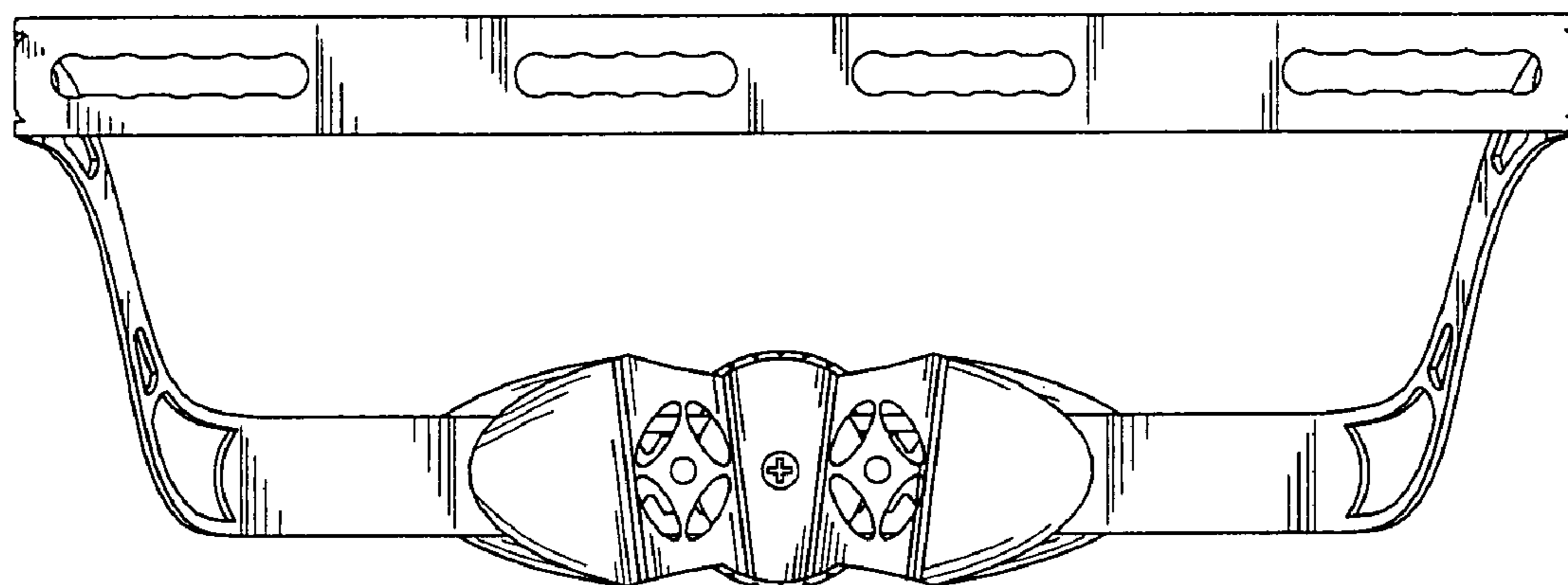

FIG. 3

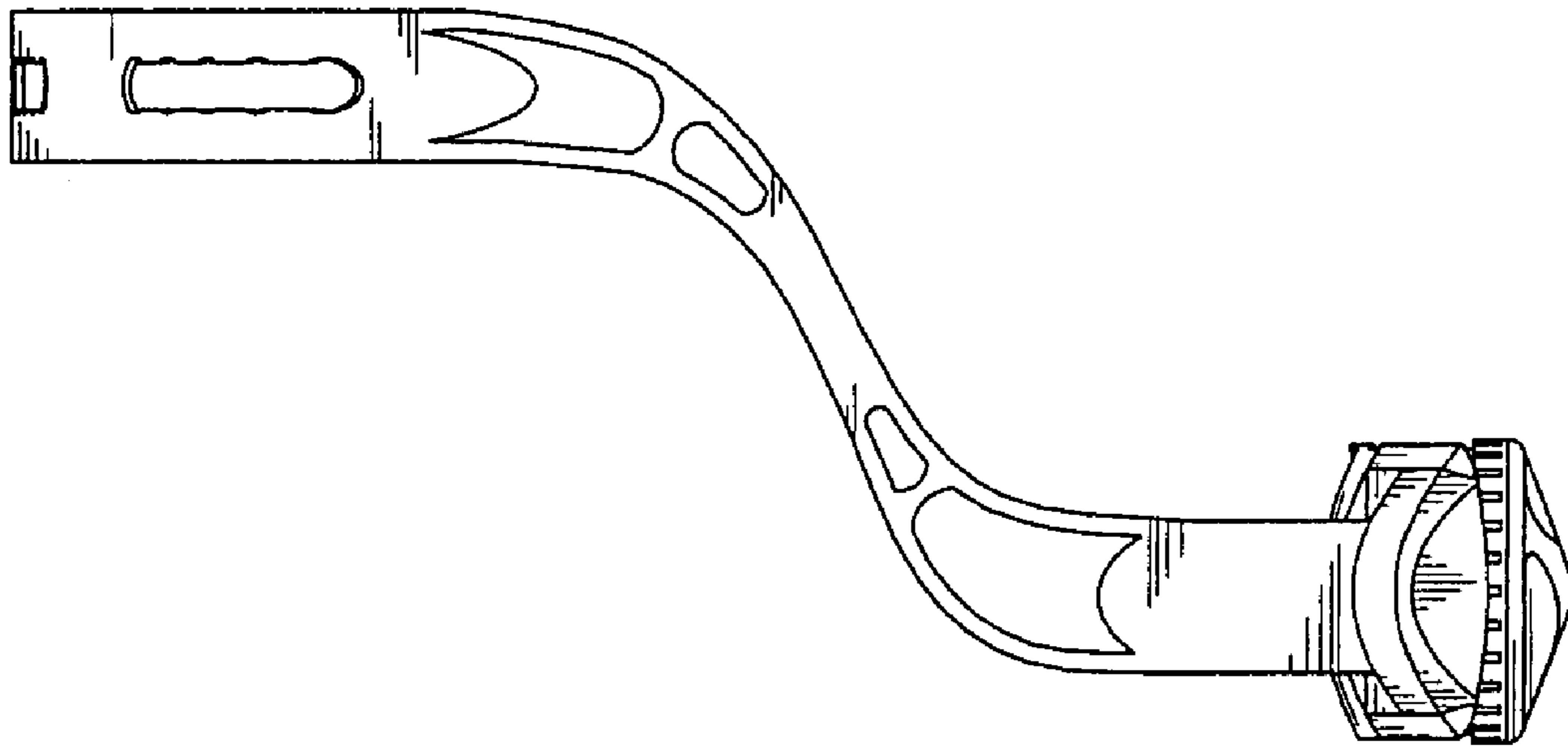

FIG. 4

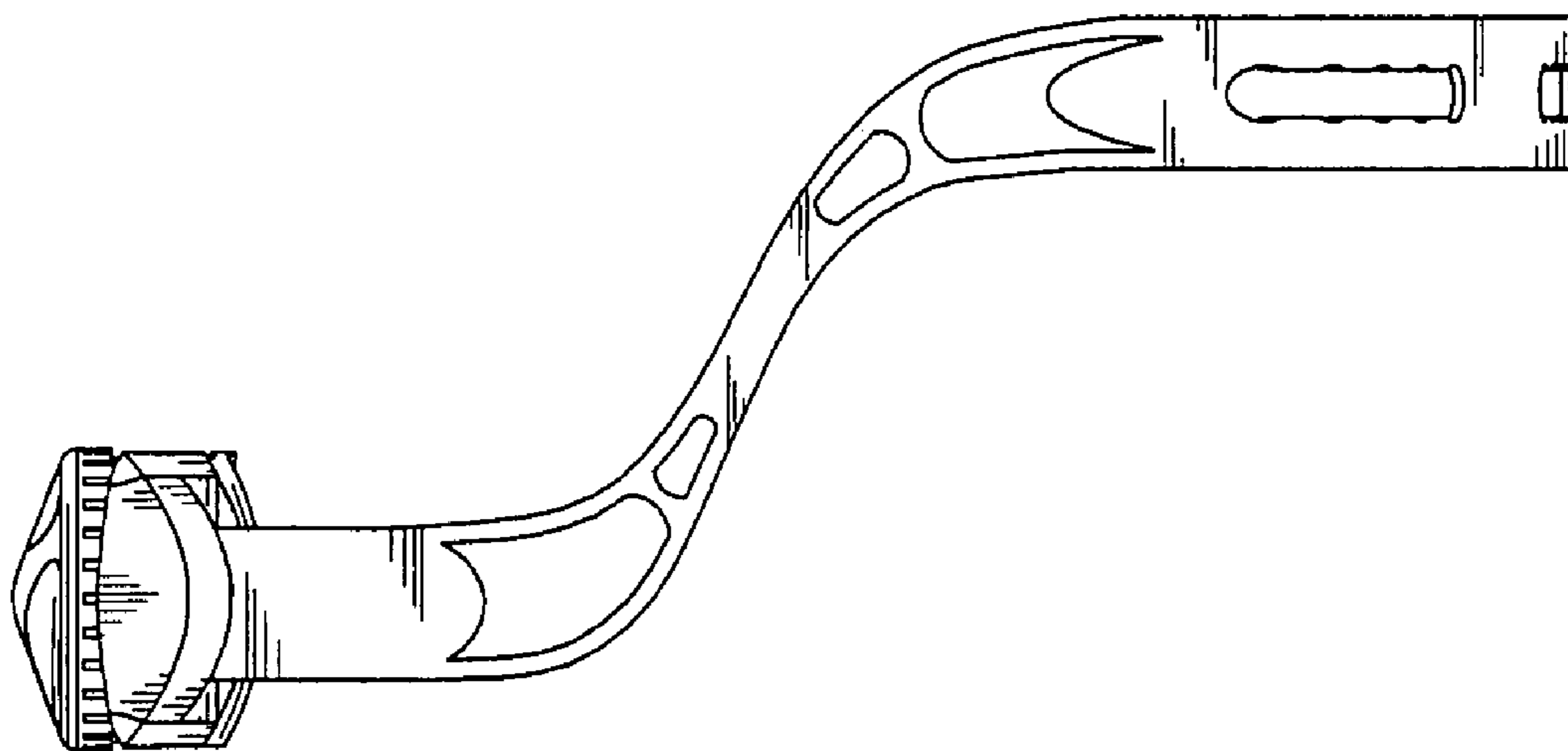

FIG. 5

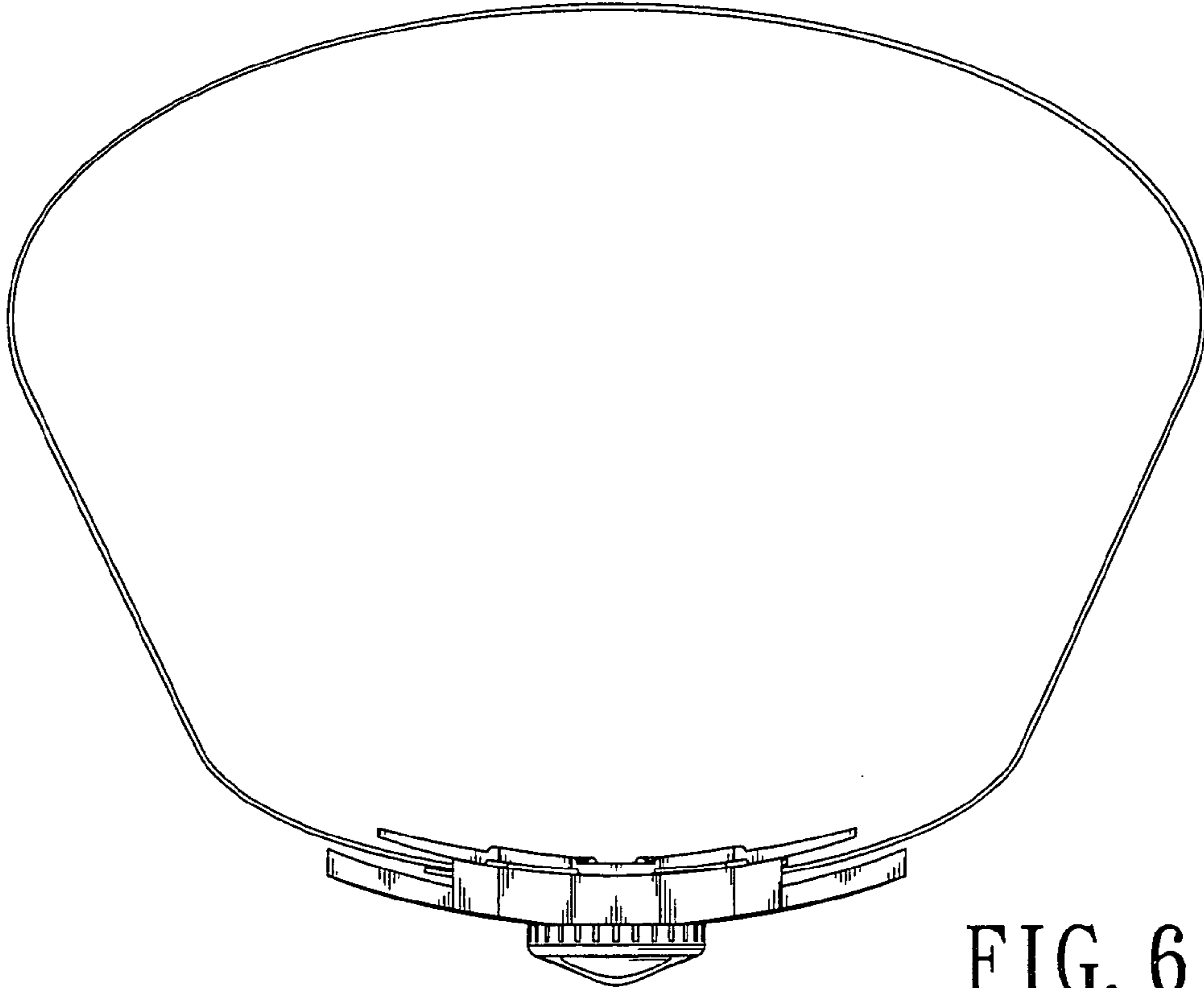

FIG. 6

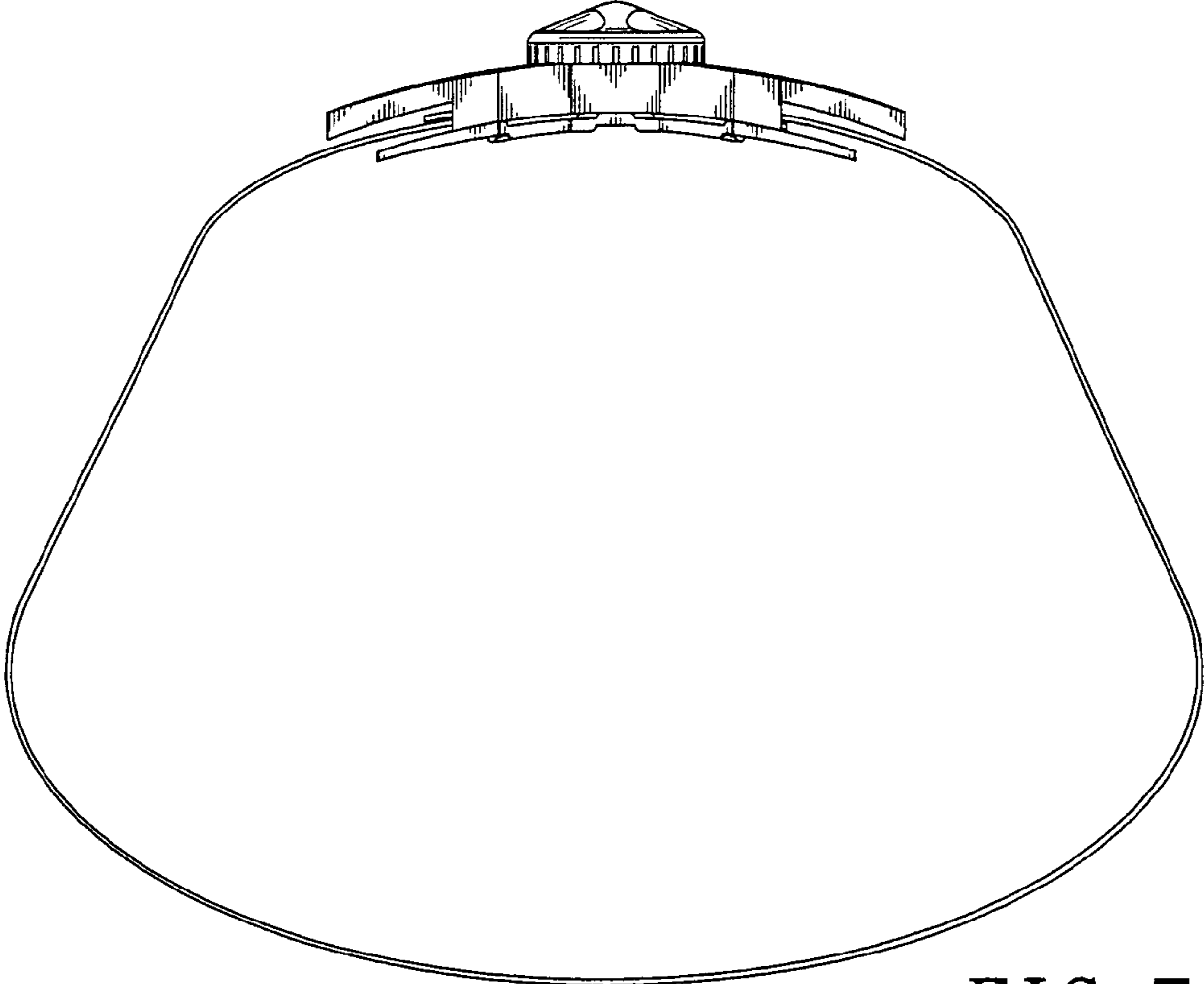

FIG. 7