



US00D581048S

(12) **United States Design Patent**
Kawamura

(10) **Patent No.:** **US D581,048 S**
(45) **Date of Patent:** **** Nov. 18, 2008**

(54) **PLUNGER ROD FOR SYRINGE**

(76) Inventor: **Hideaki Kawamura**, 38-2, Sumida
3-chome, Sumida-ku, Tokyo (JP)
131-0031

(**) Term: **14 Years**

(21) Appl. No.: **29/294,128**

(22) Filed: **Dec. 21, 2007**

(30) **Foreign Application Priority Data**

Sep. 13, 2007 (JP) 2007-24910

(51) **LOC (8) Cl.** **24-02**

(52) **U.S. Cl.** **D24/130**

(58) **Field of Classification Search** D24/112,
D24/114, 127-131; 604/54, 110, 192, 263,
604/295, 218, 187, 173, 573, 577-578, 570
See application file for complete search history.

(56) **References Cited**

U.S. PATENT DOCUMENTS

D332,308	S *	1/1993	Imbert et al.	D24/130
5,624,402	A *	4/1997	Imbert	604/111
6,171,283	B1 *	1/2001	Perez et al.	604/192
D438,955	S *	3/2001	Rudzena et al.	D24/121
6,196,998	B1 *	3/2001	Jansen et al.	604/111
D460,178	S *	7/2002	Courteix	D24/130
D461,557	S *	8/2002	Courteix	D24/130
D469,178	S *	1/2003	Courteix	D24/130
6,520,935	B1 *	2/2003	Jansen et al.	604/111
D484,243	S *	12/2003	Ryan et al.	D24/146
6,719,732	B2 *	4/2004	Courteix	604/192
6,752,782	B2 *	6/2004	Liao	604/110
D494,677	S *	8/2004	Garvin	D24/130
D565,732	S *	4/2008	Pech et al.	D24/130
2003/0105434	A1 *	6/2003	Chang	604/198
2007/0123830	A1 *	5/2007	Fierkens et al.	604/240

* cited by examiner

Primary Examiner—Ian Simmons

Assistant Examiner—Eric L Goodman

(74) *Attorney, Agent, or Firm*—Chapman and Cutler LLP

(57) **CLAIM**

The ornamental design for a plunger rod for syringe, as shown and described.

DESCRIPTION

FIG. 1 is a top perspective view of a plunger rod for syringe showing my new design;

FIG. 2 is a bottom perspective view thereof;

FIG. 3 is a front elevational view thereof;

FIG. 4 is a rear elevational view thereof;

FIG. 5 is a left side elevational view thereof;

FIG. 6 is a right side elevational view thereof;

FIG. 7 is a top plan view thereof;

FIG. 8 is a bottom plan view thereof;

FIG. 9 is a sectional view thereof taken along line 9—9 of FIG. 7;

FIG. 10 is a sectional view thereof taken along line 10—10 of FIG. 8;

FIG. 11 is a sectional view thereof taken along line 11—11 of FIG. 8;

FIG. 12 is a sectional view thereof taken along line 12—12 of FIG. 3;

FIG. 13 is a sectional view thereof taken along line 13—13 of FIG. 3; and,

FIG. 14 is a bottom perspective view thereof.

The broken lines are for illustrative purposes only and form no part of the claimed design.

1 Claim, 4 Drawing Sheets

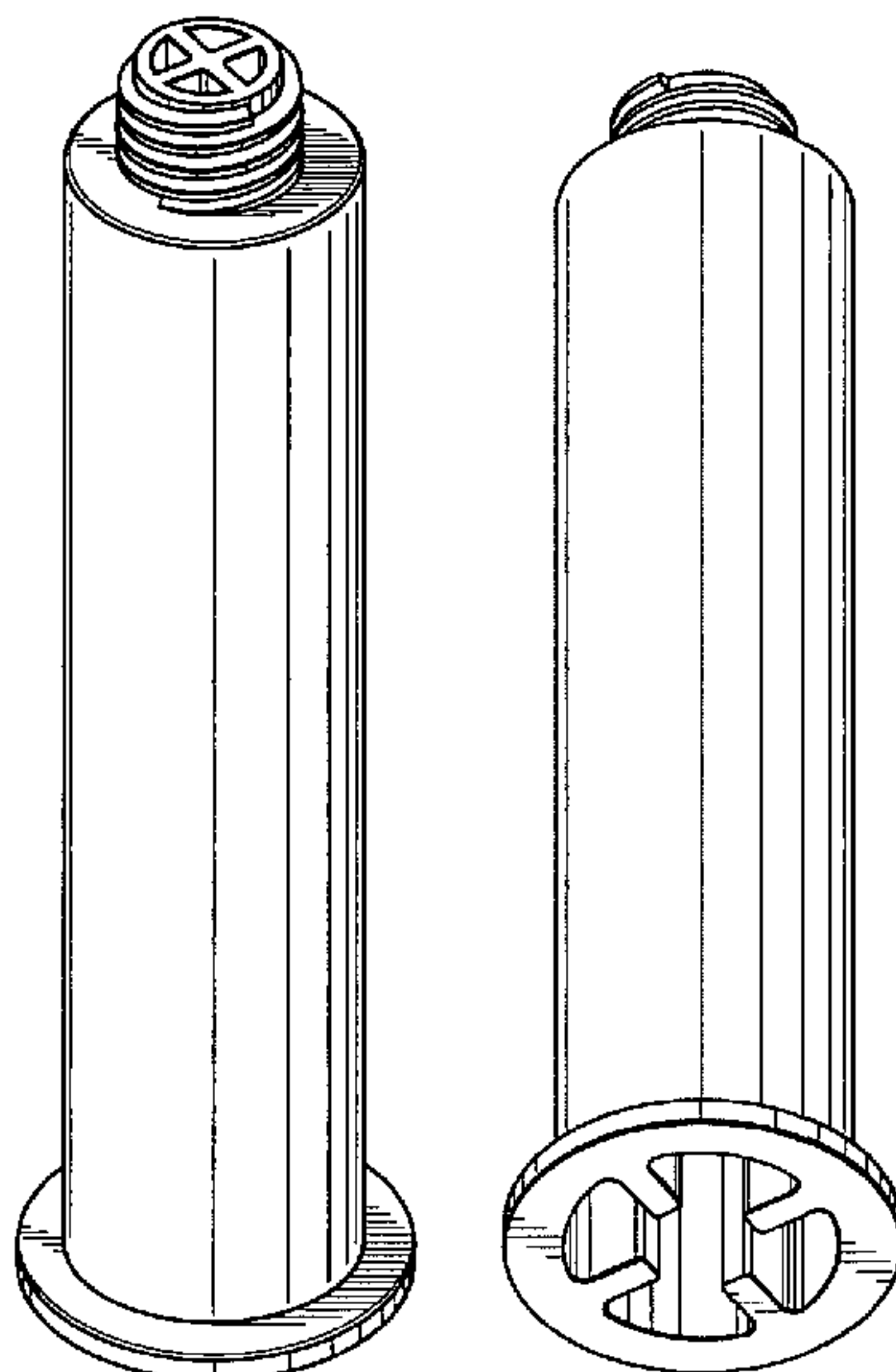

Fig. 1

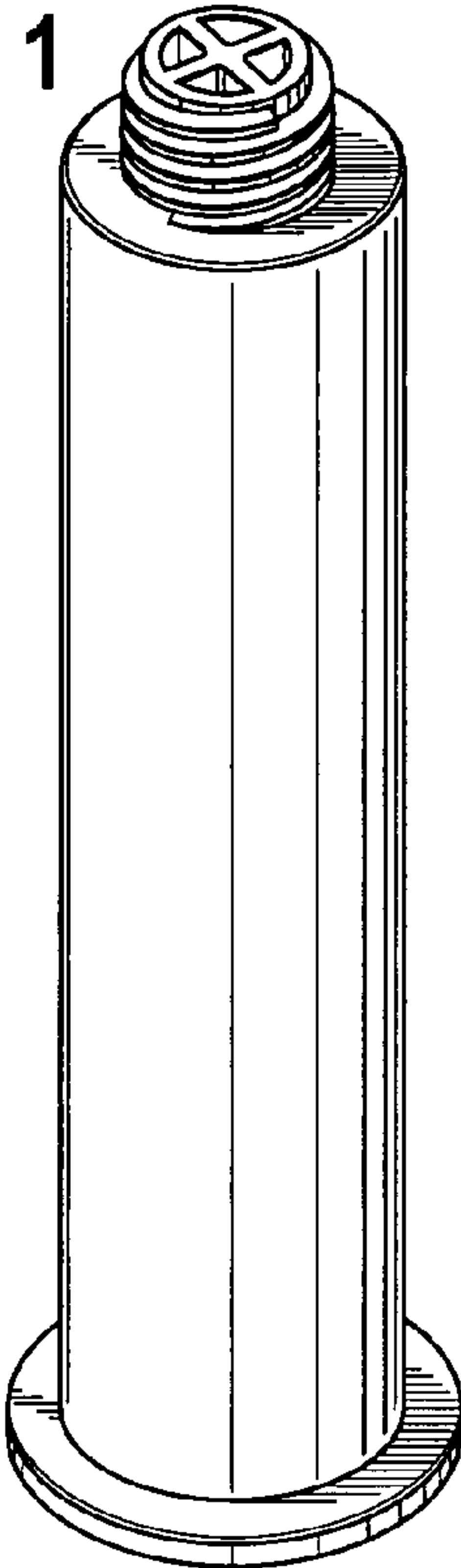

Fig. 2

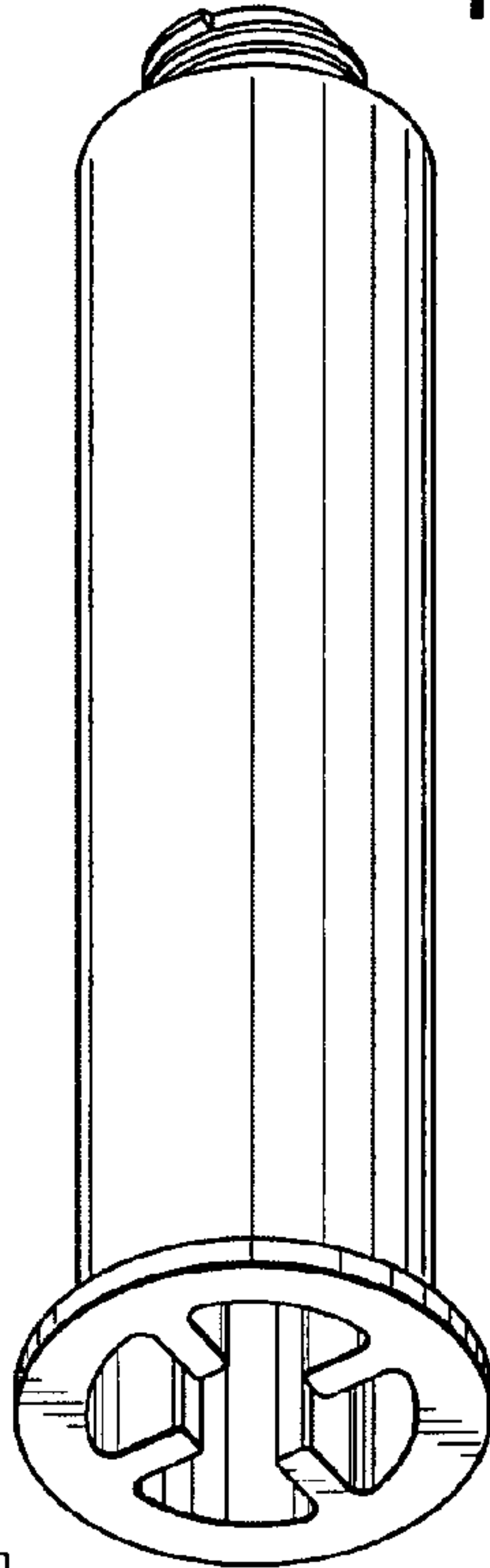

Fig. 3

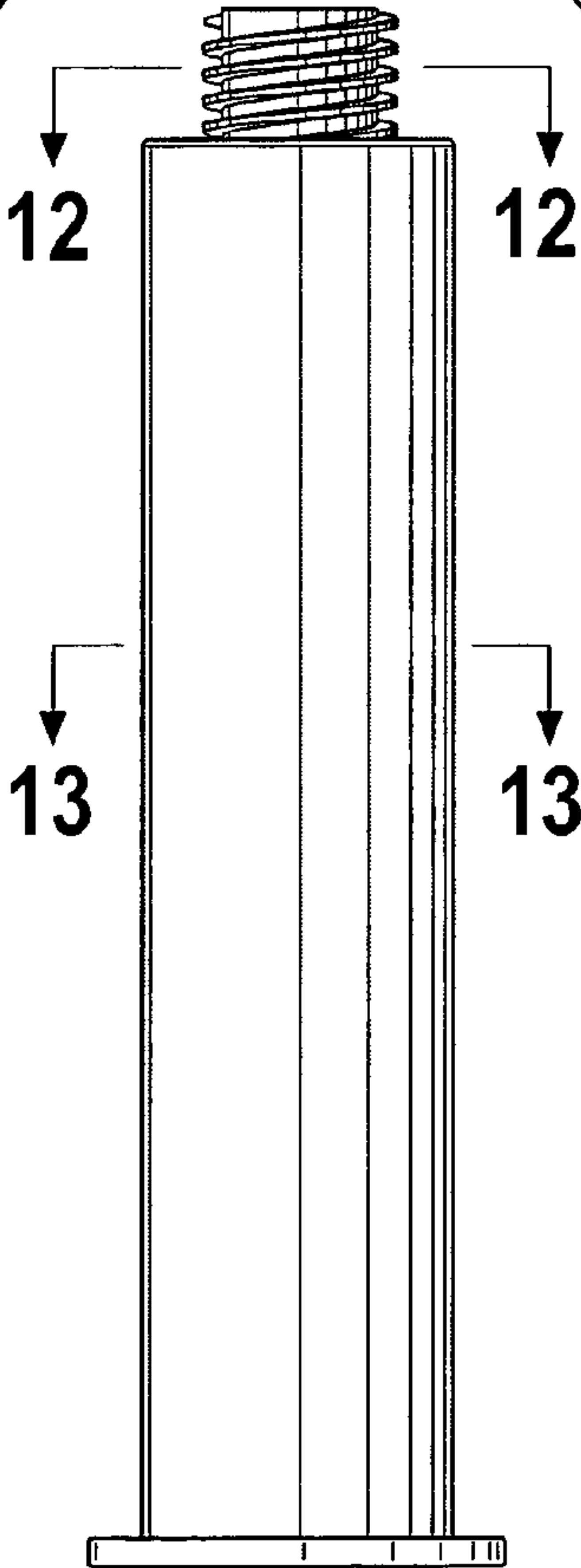

Fig. 4

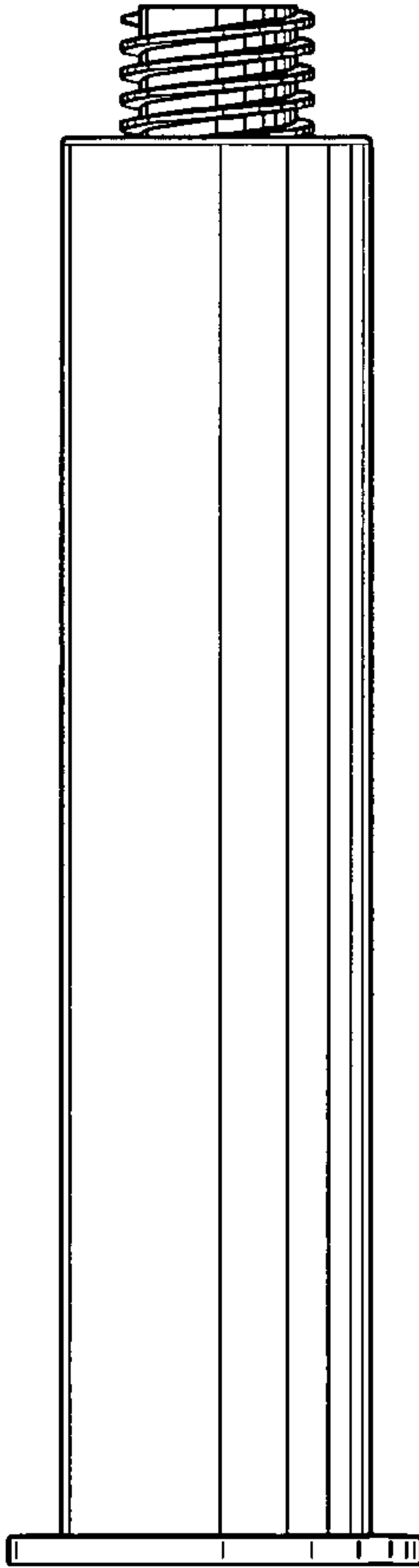

Fig. 5

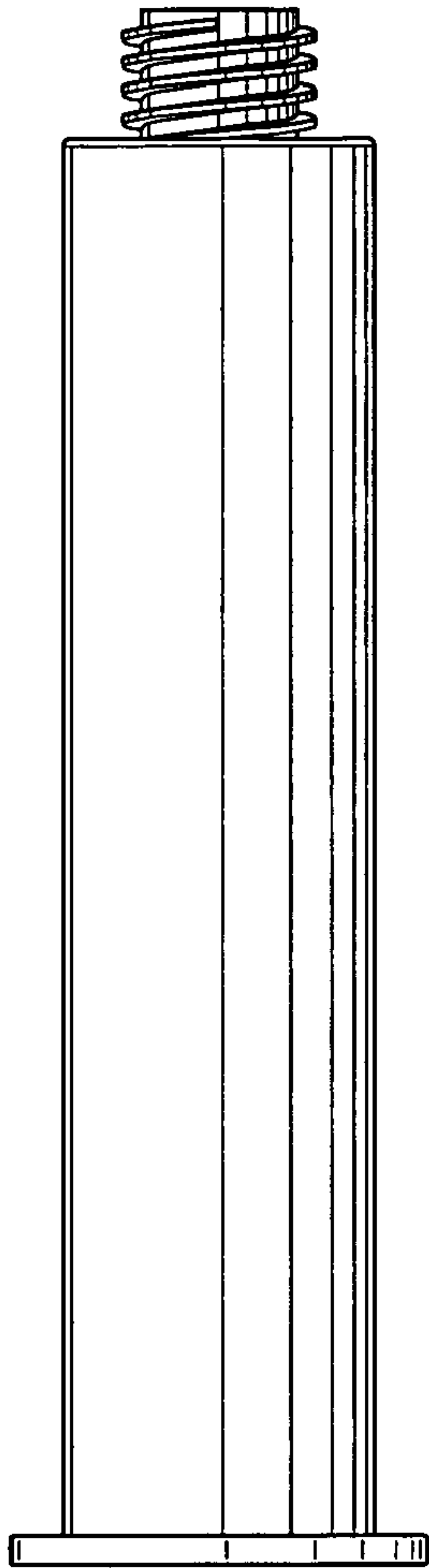

Fig. 6

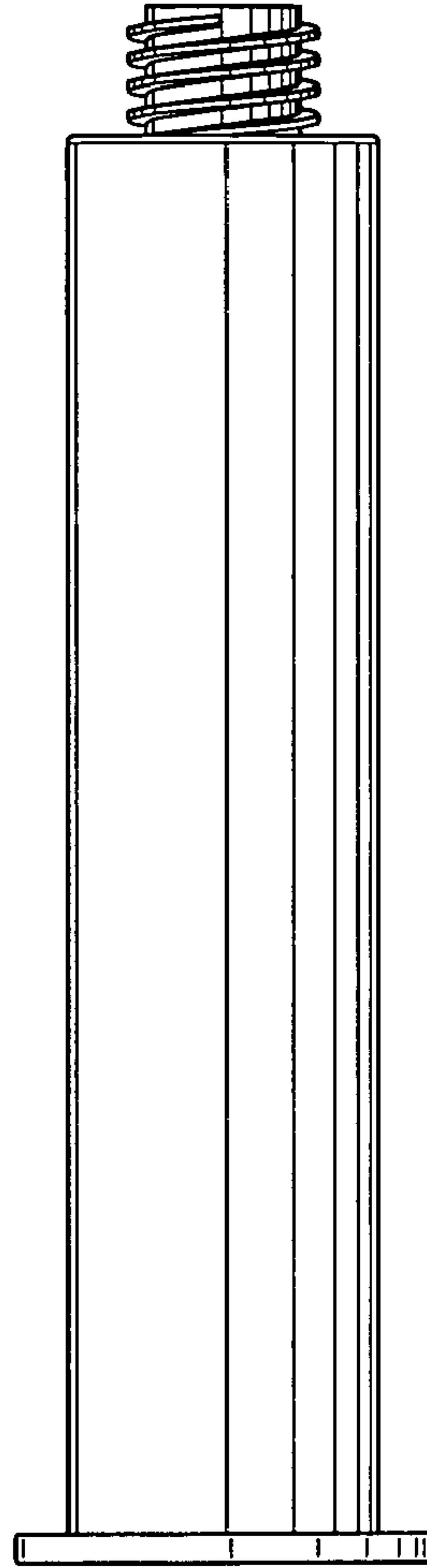

Fig. 7

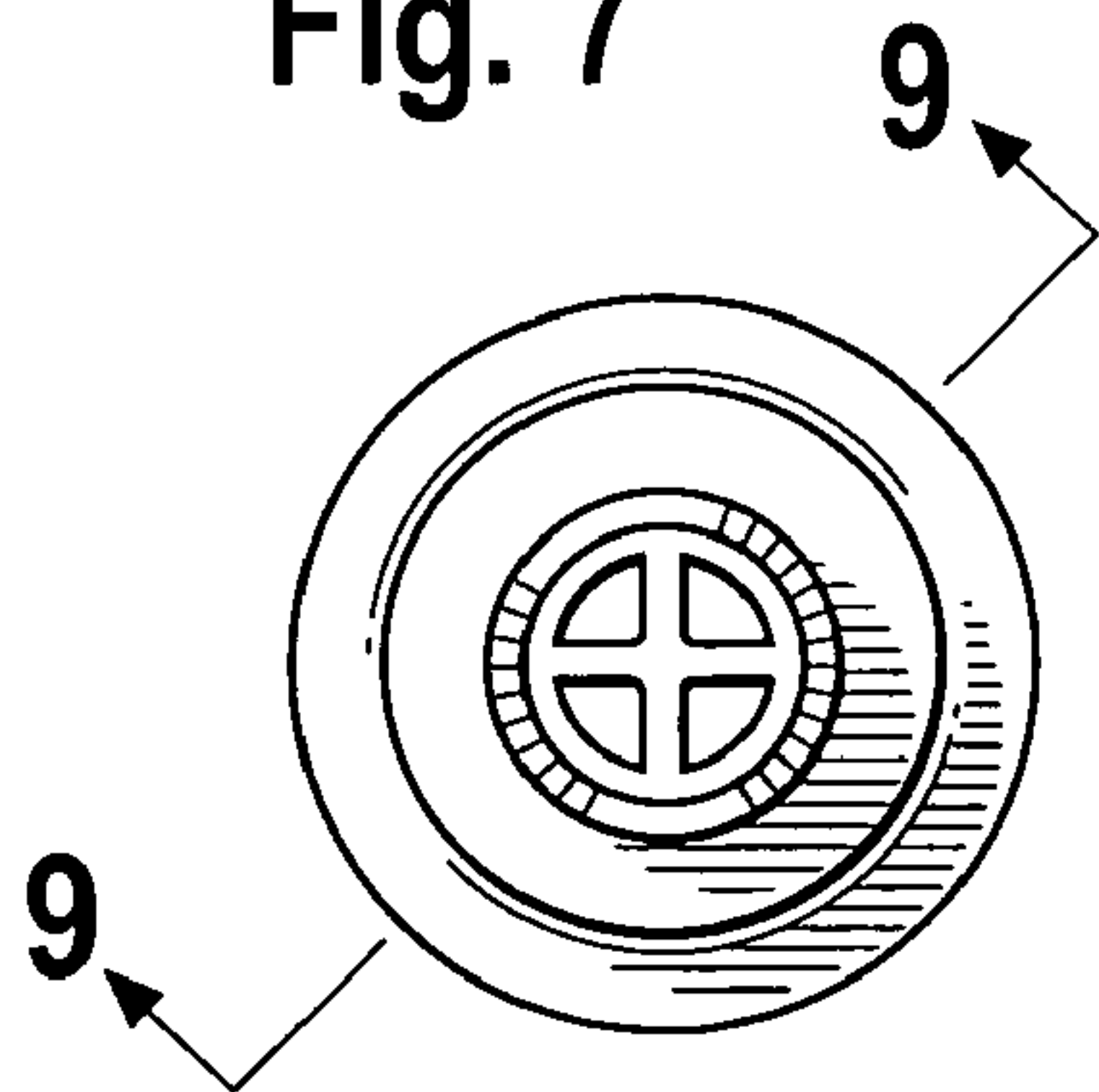

Fig. 8

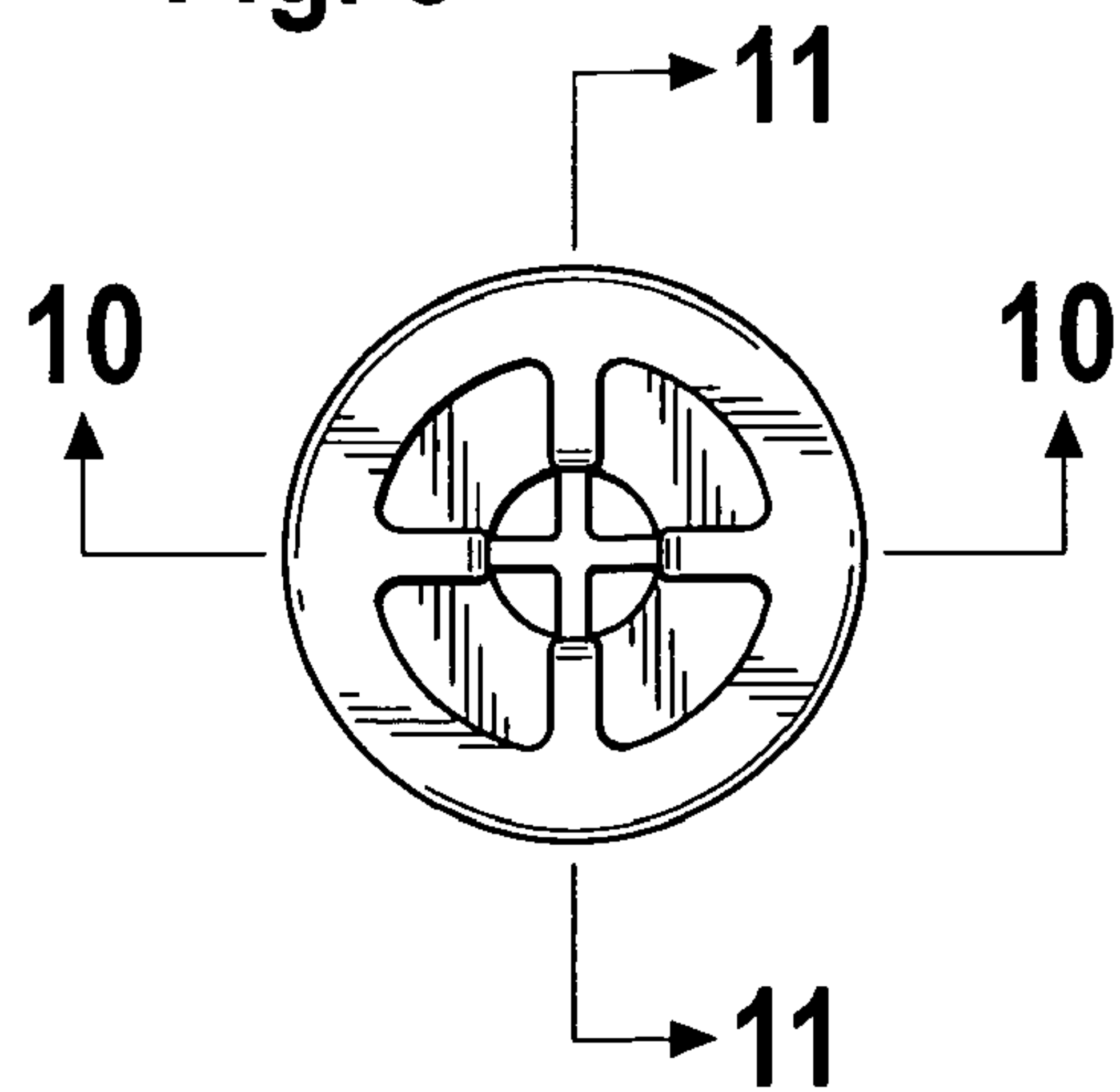

Fig. 9

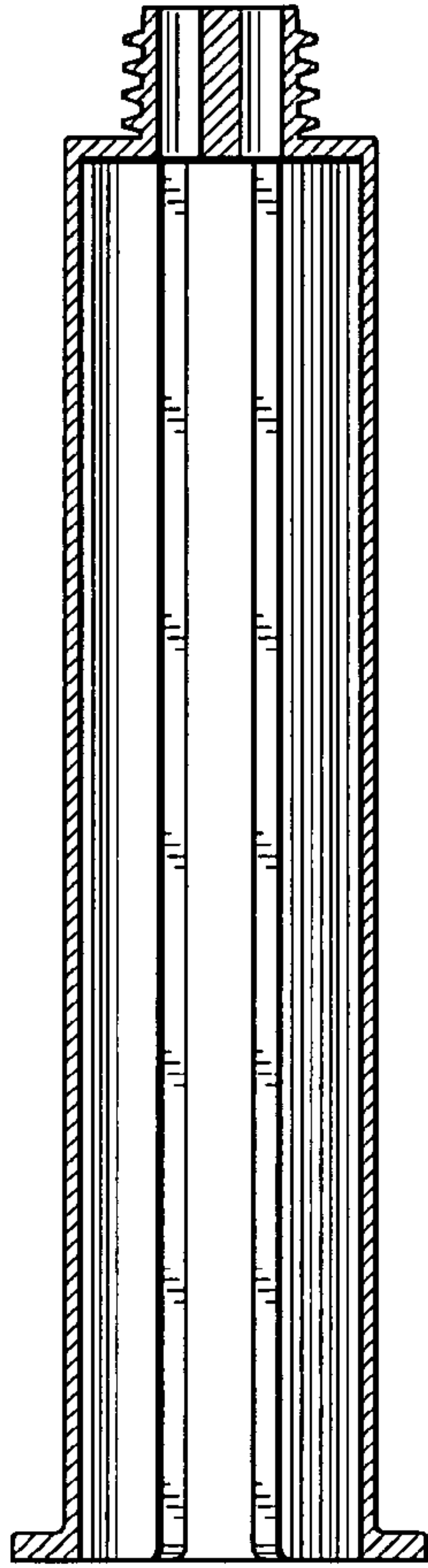

Fig. 10

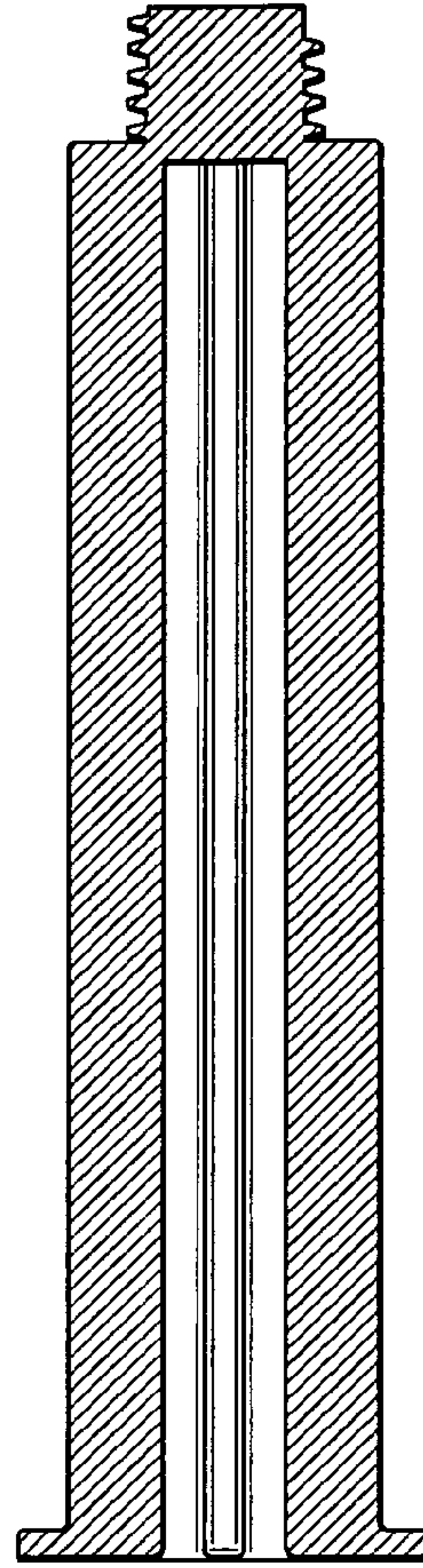

Fig. 11

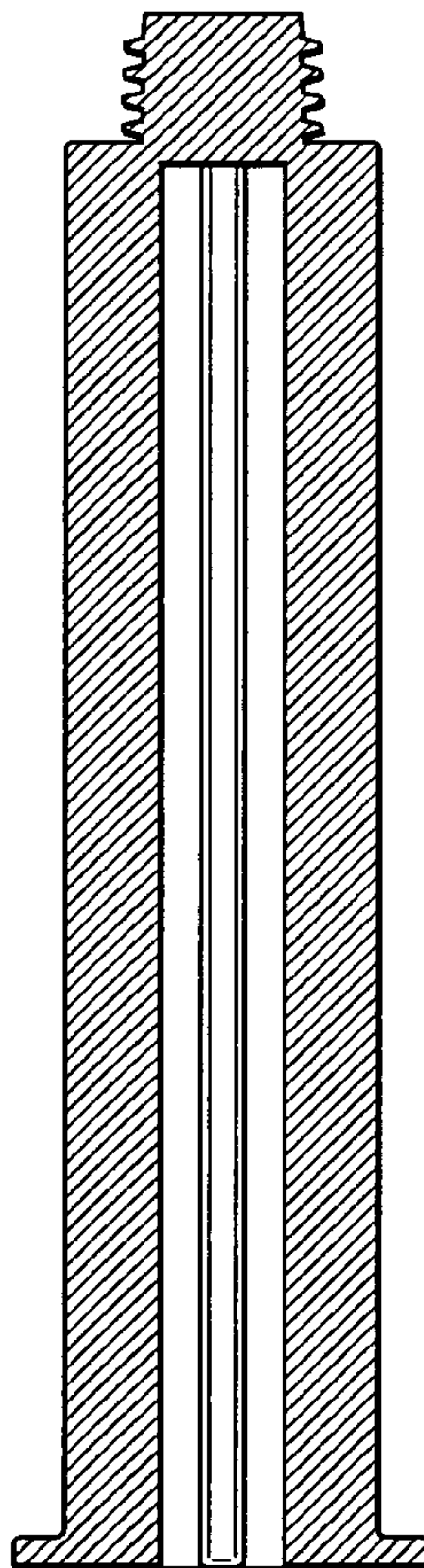

Fig. 12

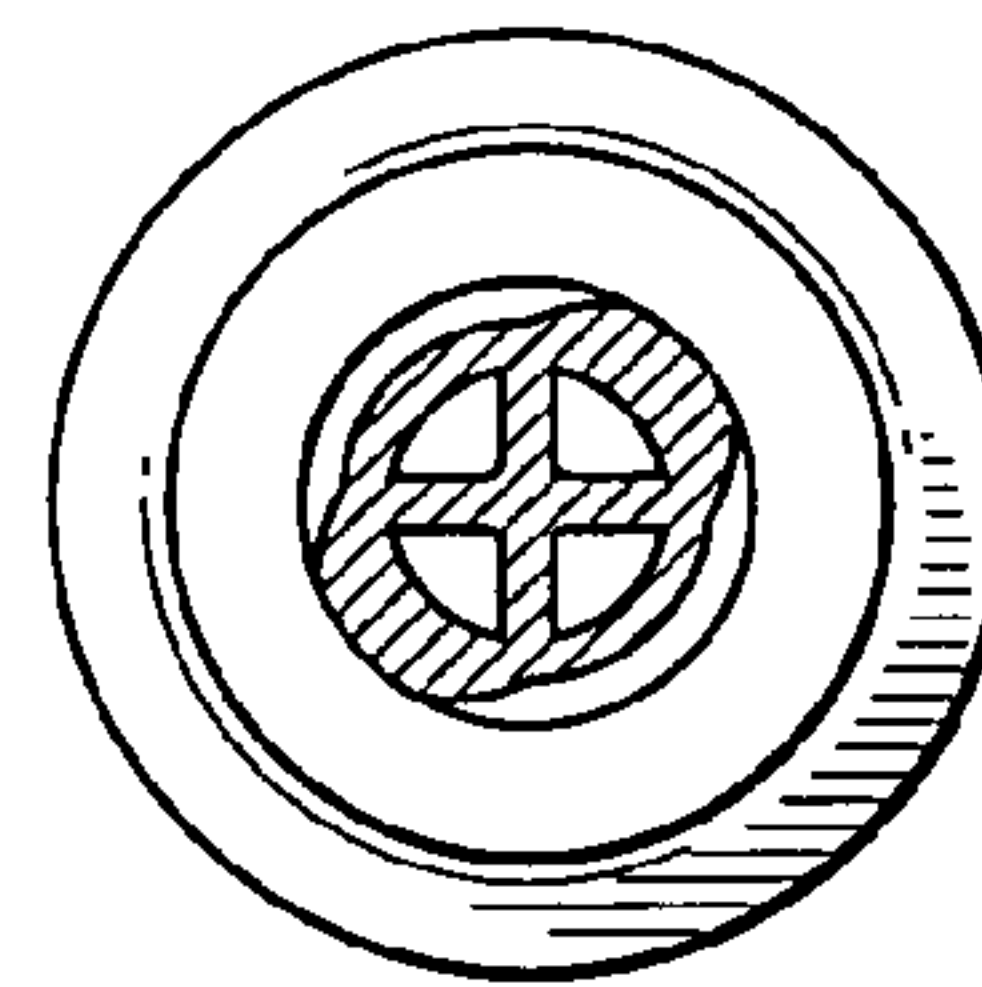

Fig. 13

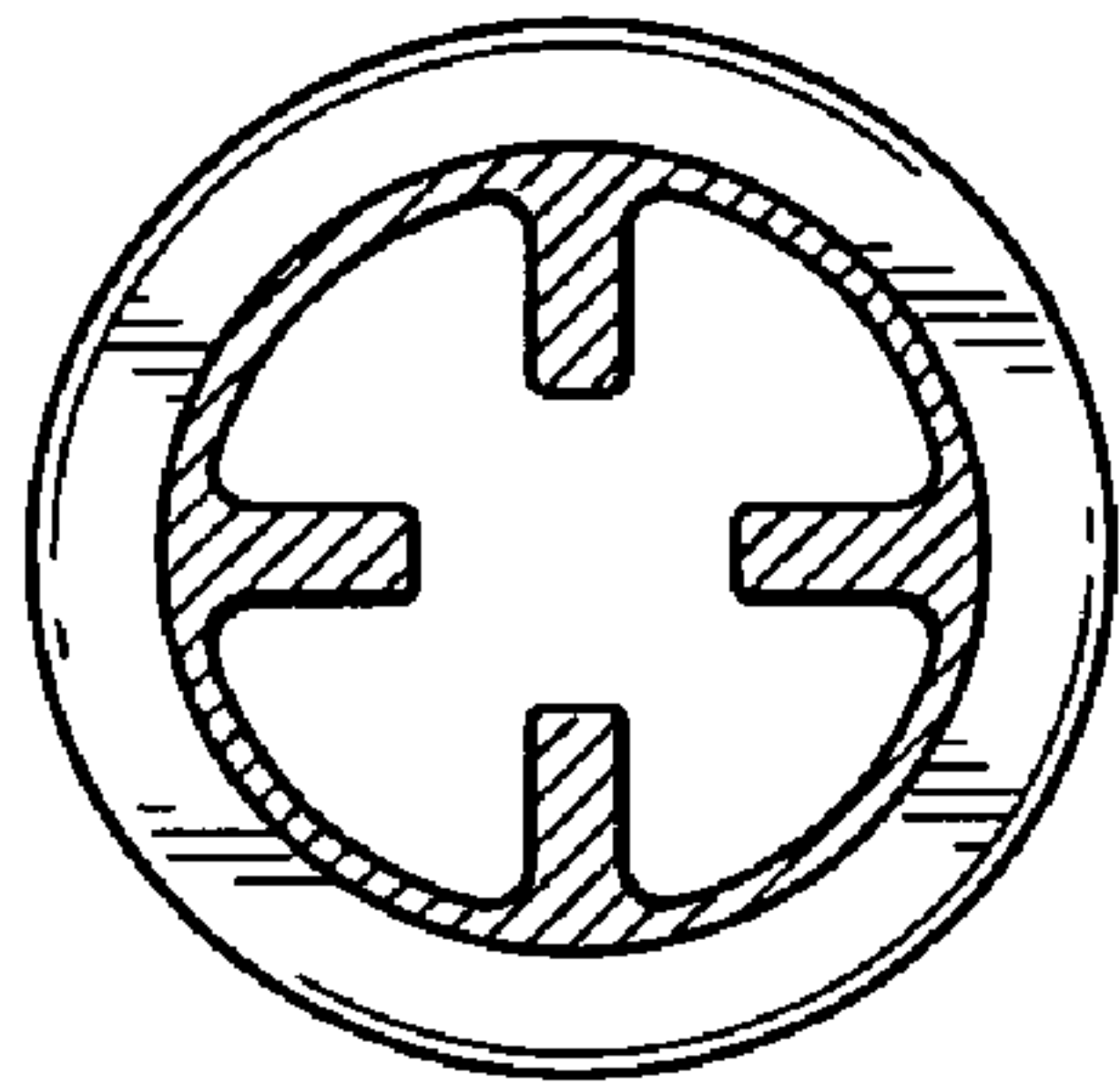

Fig. 14

