



US00D580598S

(12) **United States Design Patent**
Yamada et al.

(10) **Patent No.:** **US D580,598 S**
(45) **Date of Patent:** **** Nov. 11, 2008**

(54) **COSMETIC CONTAINER**

(75) Inventors: **Kazuhiro Yamada**, Ashiya (JP);
Teruhisa Hirano, Kobe (JP); **Yayoi Hamada**, Kobe (JP); **Akiko Ashiwa**, Singapore (SG)

(73) Assignee: **The Procter & Gamble Company**, Cincinnati, OH (US)

(**) Term: **14 Years**

(21) Appl. No.: **29/291,447**

(22) Filed: **Aug. 29, 2007**

(51) **LOC (8) Cl.** **28-03**

(52) **U.S. Cl.** **D28/82**

(58) **Field of Classification Search** 132/286–288,
132/293–307, 312–318; D28/76–84; 206/581,
206/823; 220/DIG. 26

See application file for complete search history.

(56) **References Cited**

U.S. PATENT DOCUMENTS

D27,622 S *	9/1897	Zoerb	D28/82
4,132,306 A *	1/1979	Margolin	220/DIG. 26
D337,177 S *	7/1993	Tiramani et al.	D28/76
D339,882 S *	9/1993	Chevassus	D28/82
D343,925 S *	2/1994	Garouste et al.	D28/78
D381,124 S *	7/1997	Blachut	D28/78
D455,235 S *	4/2002	Braaten et al.	D28/78
D497,037 S *	10/2004	Rodriguez	D28/82
D531,761 S *	11/2006	Zadeh et al.	D28/83
D561,944 S *	2/2008	Ashiwa et al.	D28/83

D570,546 S *	6/2008	Washington	D28/82
2004/0020509 A1 *	2/2004	Waisman	132/316
2004/0244811 A1 *	12/2004	Chen	132/301

* cited by examiner

Primary Examiner—Jennifer Rivard

(74) *Attorney, Agent, or Firm*—Eileen L. Hughett; S. Robert Chuey; Brian M. Bolam

(57) **CLAIM**

The ornamental design for a cosmetic container, as shown and described.

DESCRIPTION

FIG. 1 is a perspective view of the cosmetic container, embodying our new design;

FIG. 2 is a front view thereof;

FIG. 3 is a back view thereof;

FIG. 4 is a right side view thereof;

FIG. 5 is a left side view thereof;

FIG. 6 is a top plan view thereof;

FIG. 7 is a bottom view thereof;

FIG. 8 is a cross sectional view taken along line 8—8 in FIG. 4; and,

FIG. 9 is a perspective view of the cosmetic container in an open position.

The broken lines shown in the drawings are for illustrative purposes only and form no part of the claimed design.

1 Claim, 5 Drawing Sheets

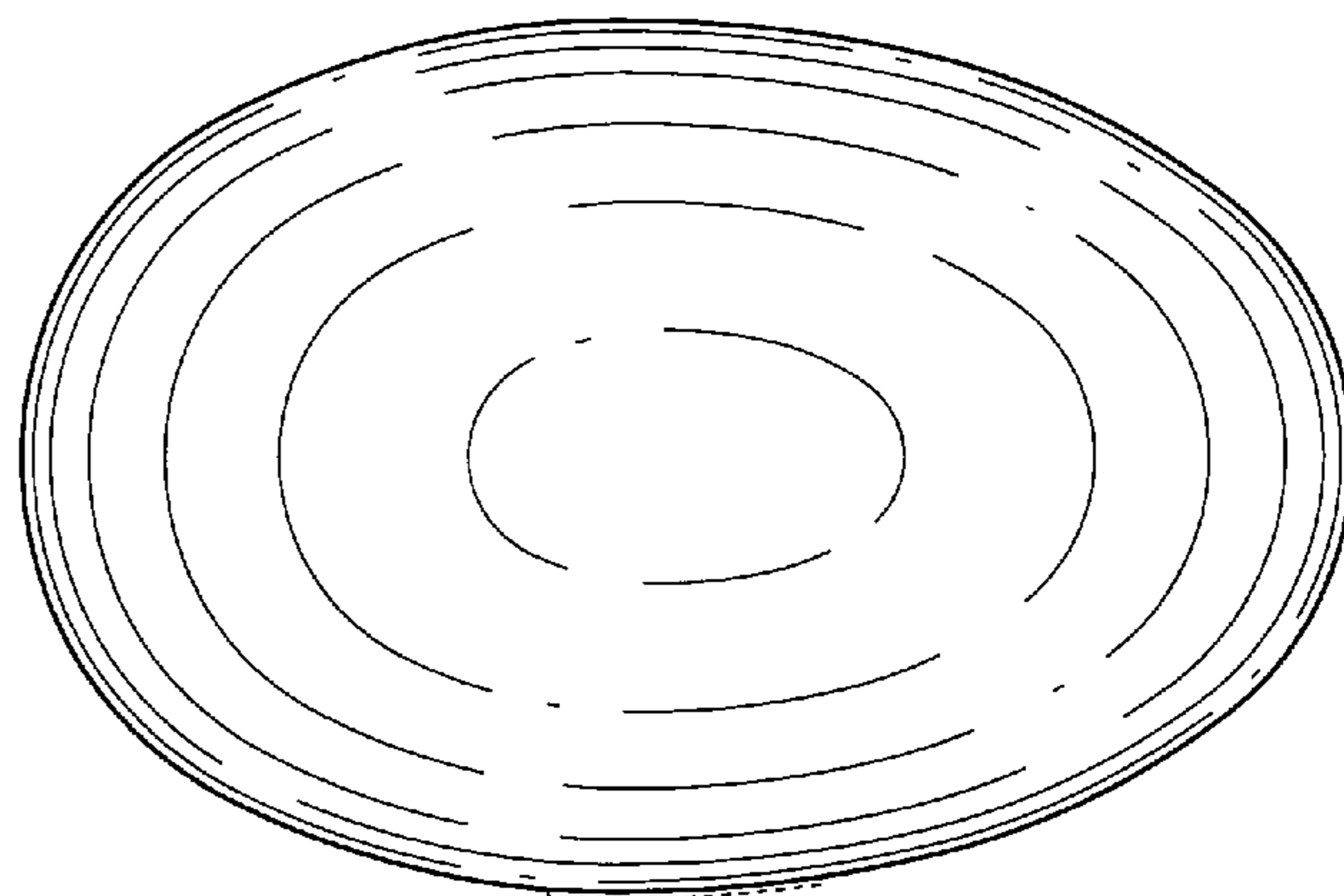
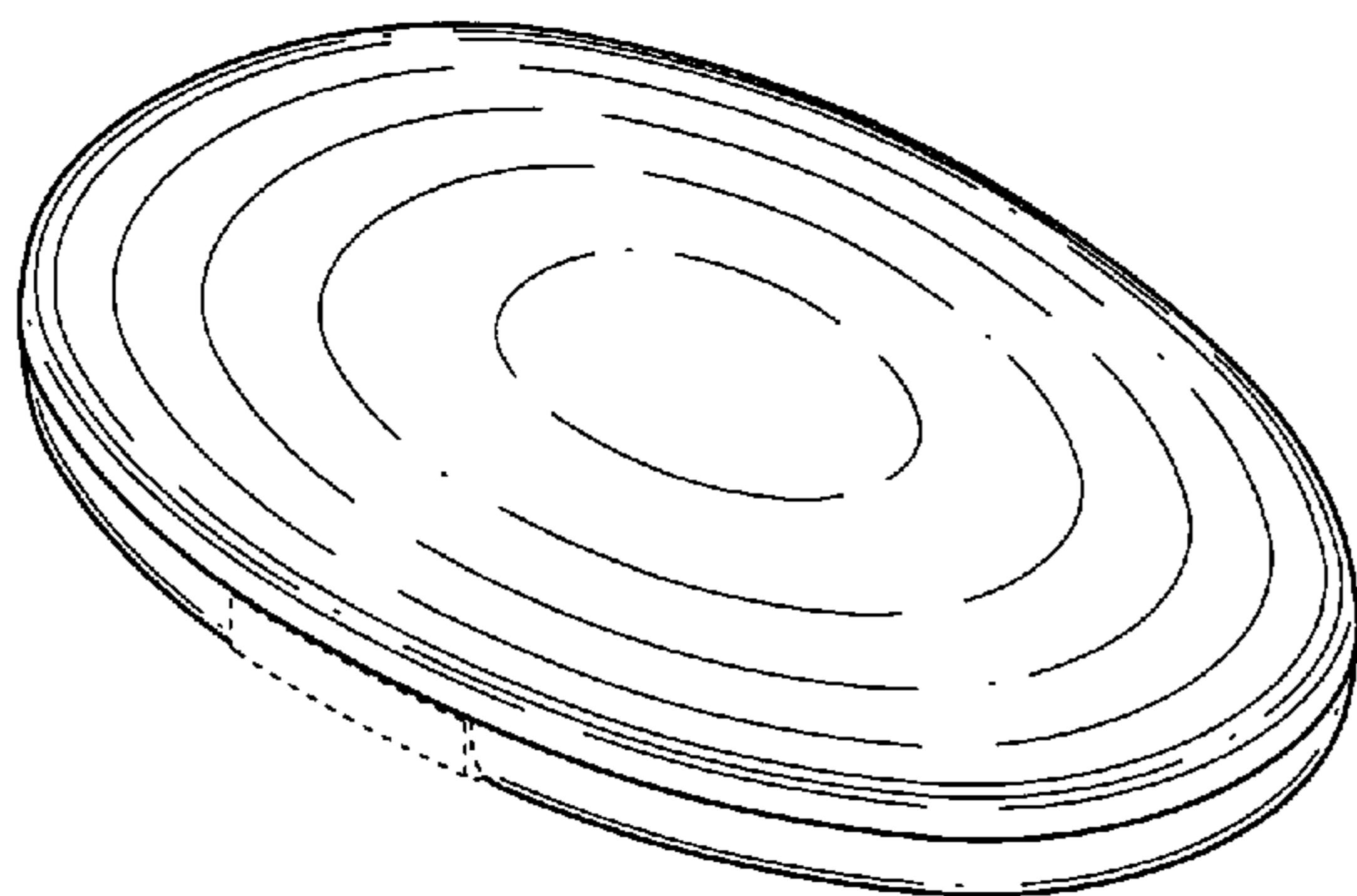

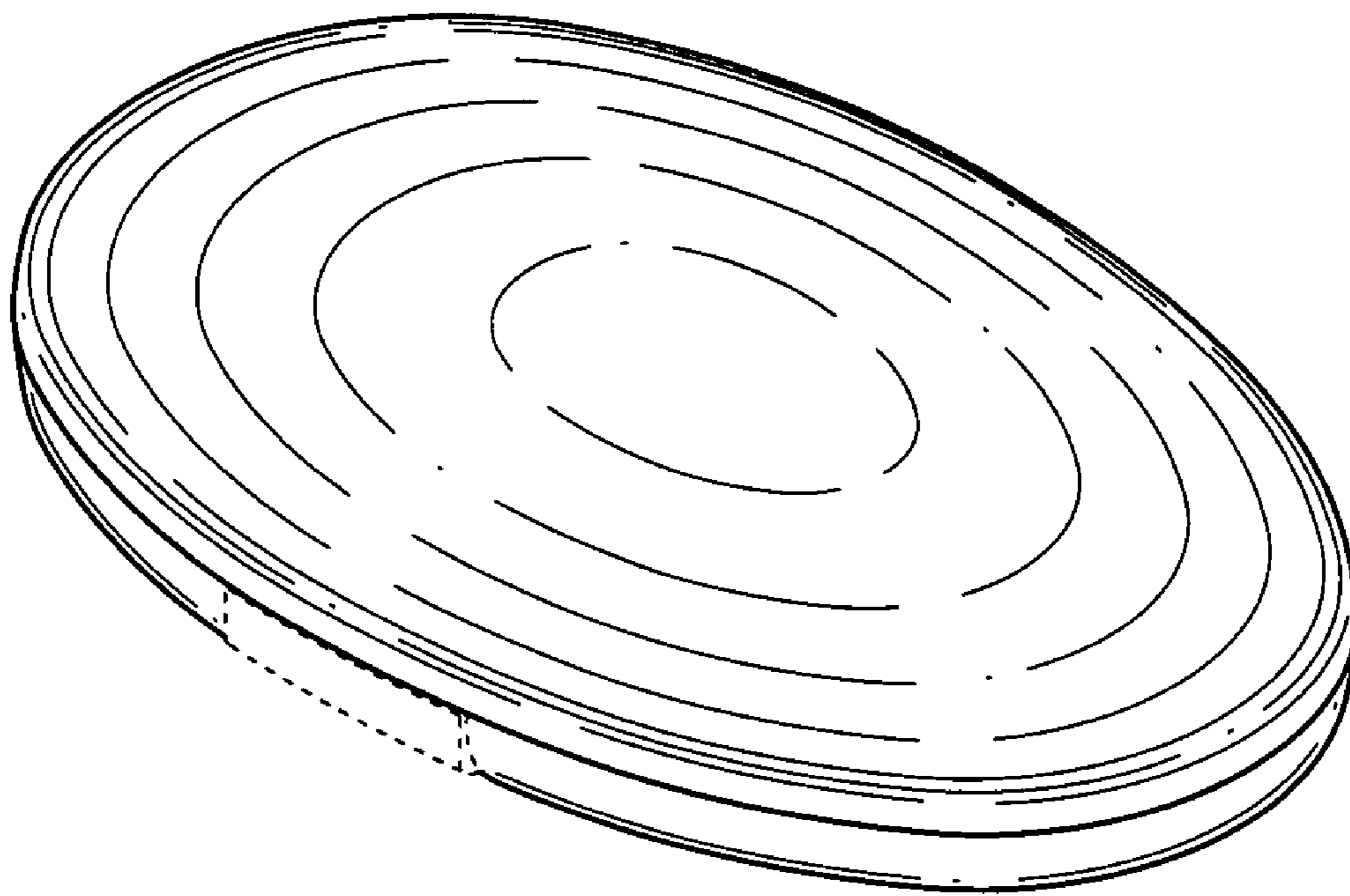

Fig. 1

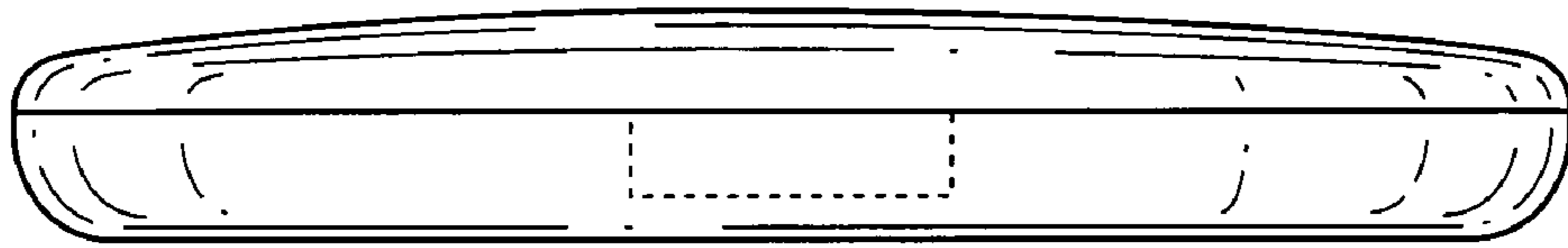

Fig. 2

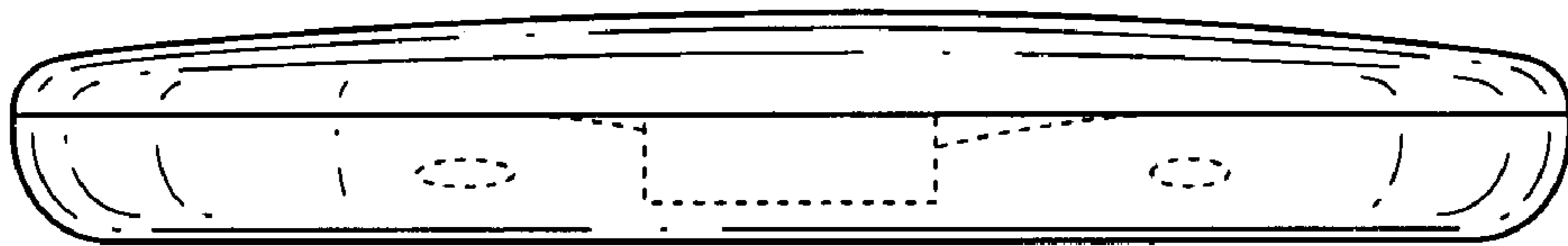

Fig. 3

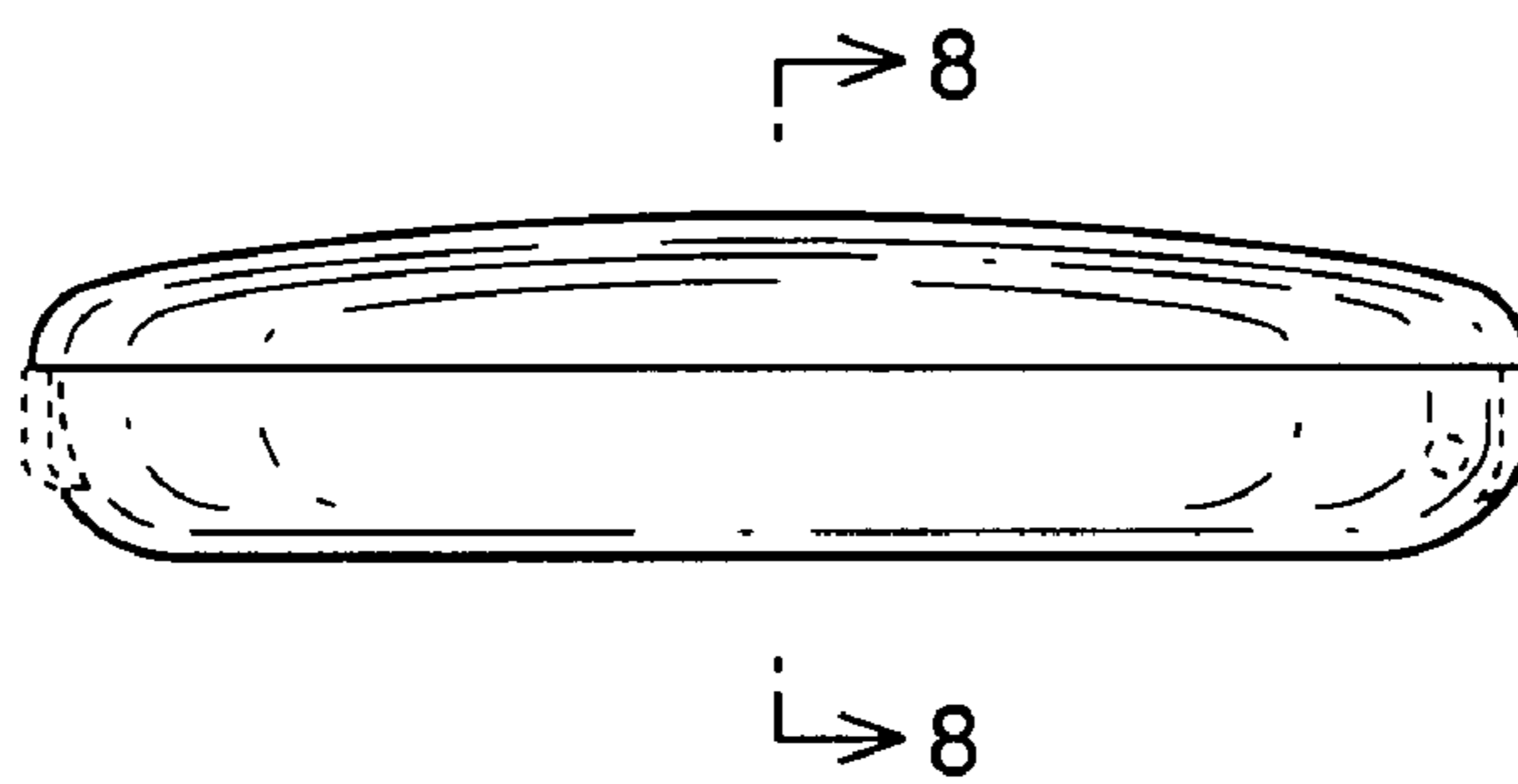

Fig. 4

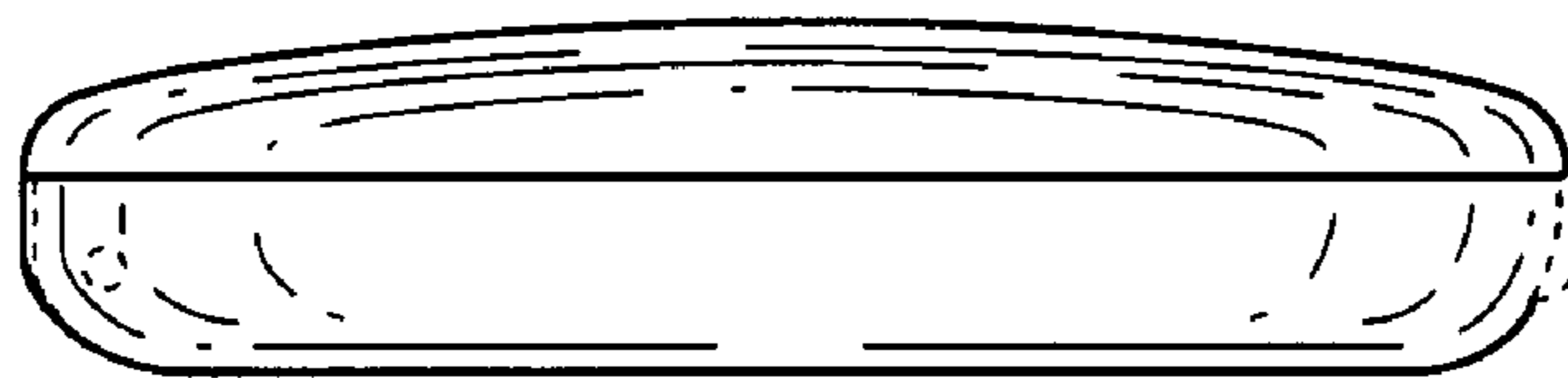

Fig. 5

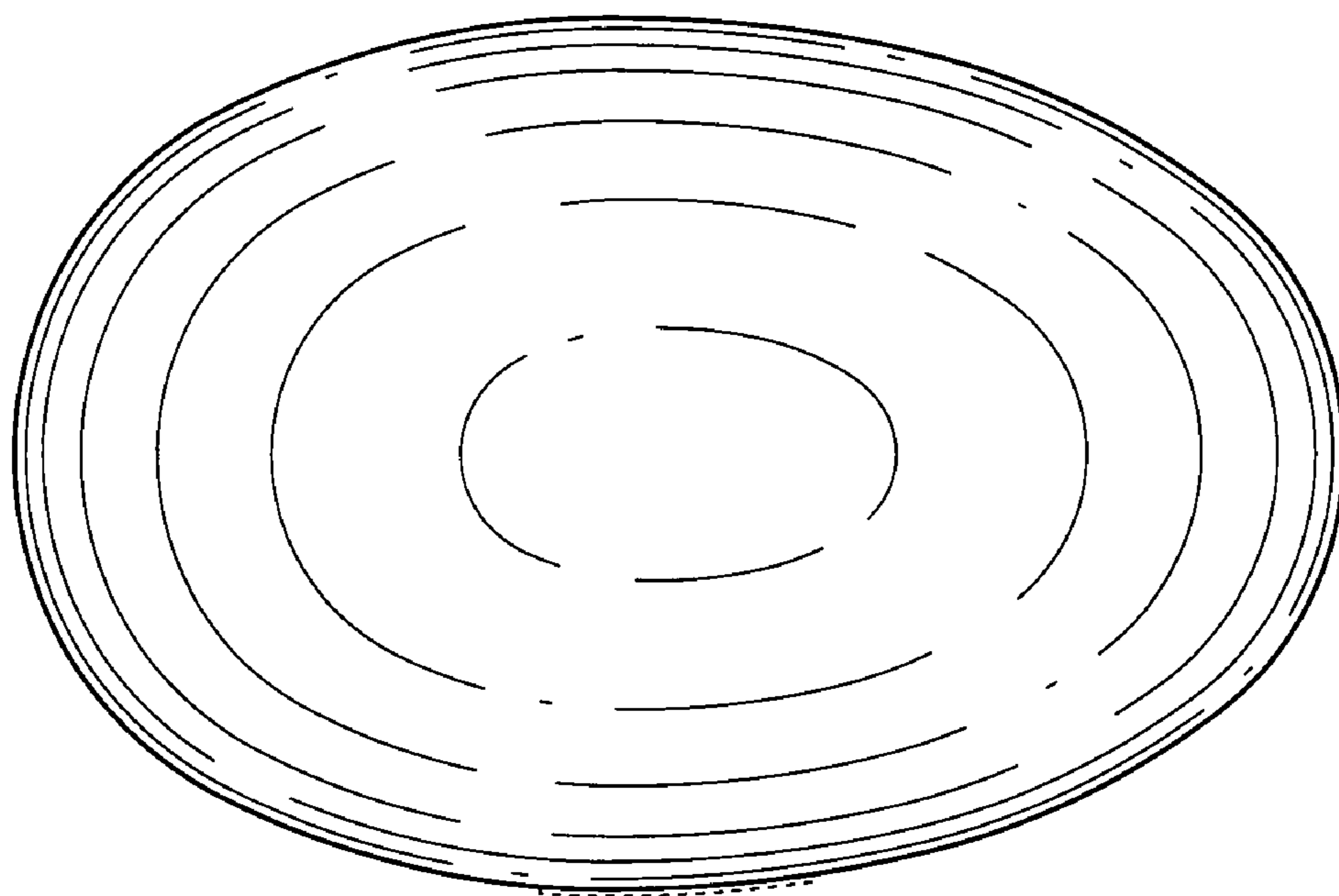

Fig. 6

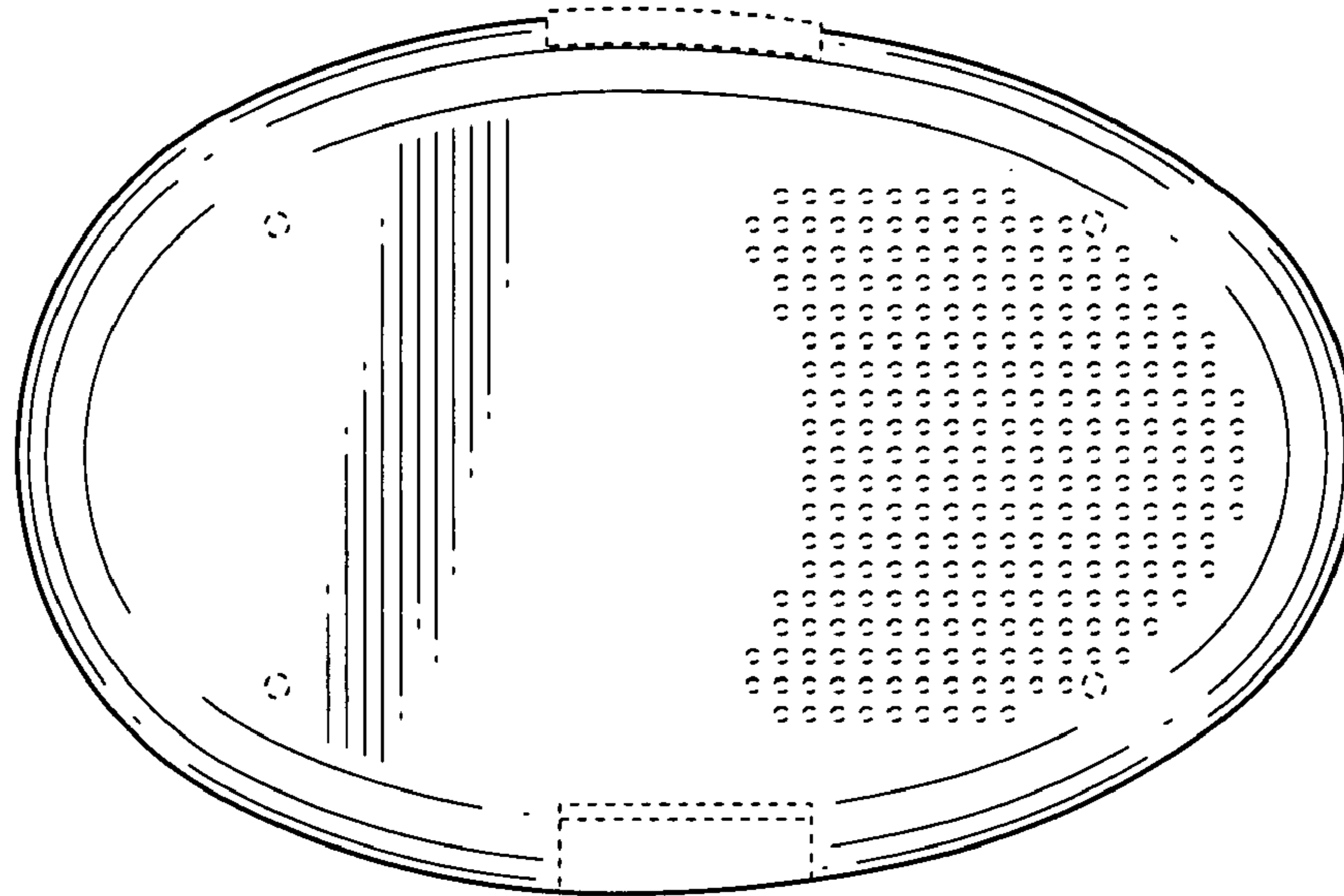

Fig. 7

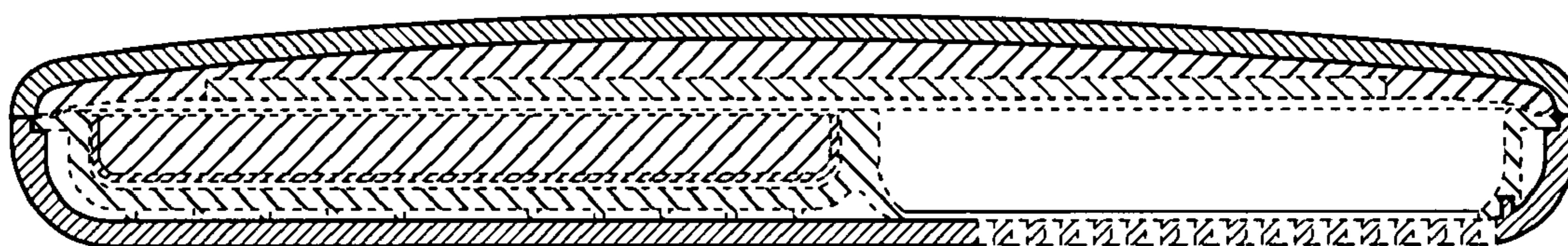

Fig. 8

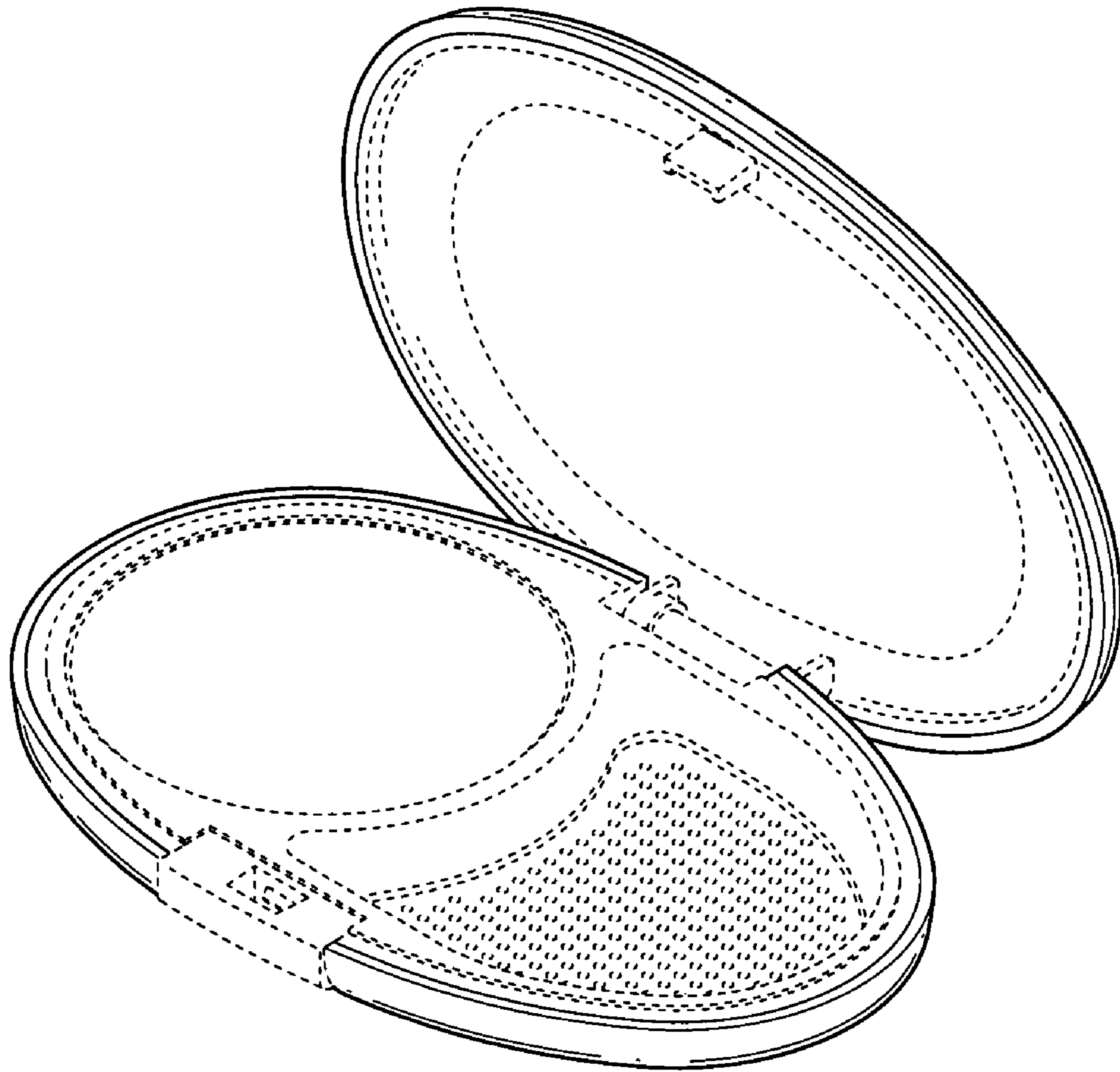

Fig. 9