

US00D580491S

(12) **United States Design Patent**
Fei

(10) **Patent No.:** **US D580,491 S**

(45) **Date of Patent:** **** Nov. 11, 2008**

(54) **PEN**

(75) **Inventor:** **Yong Fei, Ningbo (CN)**

(73) **Assignee:** **Beifa Group Co., Ltd., Ningbo (CN)**

(**) **Term:** **14 Years**

(21) **Appl. No.:** **29/282,460**

(22) **Filed:** **Jul. 20, 2007**

(30) **Foreign Application Priority Data**

Jan. 22, 2007 (CN) 2007 3 0003707

(51) **LOC (8) Cl.** **19-06**

(52) **U.S. Cl.** **D19/48**

(58) **Field of Classification Search** D19/35,
D19/36, 41, 42, 43, 44, 45, 46, 47, 48, 49,
D19/50, 51, 54, 55, 56, 57; 24/11 F, 11 P,
24/11 R; 401/52, 99, 100, 104, 105, 106,
401/107, 108, 109, 243, 244, 245, 246, 247
See application file for complete search history.

(56) **References Cited**

U.S. PATENT DOCUMENTS

D170,539 S	10/1953	Lovejoy	
D179,538 S	1/1957	Harper	
2,800,883 A	7/1957	Sams	
D189,735 S	2/1961	Platt	
D191,078 S	8/1961	Lovejoy	
D213,341 S	2/1969	Fields	
D218,492 S	8/1970	Bich	
D250,478 S	12/1978	Jahraus	
D252,690 S *	8/1979	Wong	D19/36
D268,935 S	5/1983	Horntrich	
D282,378 S *	1/1986	Ohyabu et al.	D19/43
D299,470 S *	1/1989	Mock	D19/43

D303,124 S *	8/1989	Li	D19/36
D307,601 S *	5/1990	Poisson et al.	D19/43
D308,075 S *	5/1990	Yazaki	D19/43
D319,845 S *	9/1991	Grotsch et al.	D19/48
D334,589 S *	4/1993	Shike et al.	D19/36
D335,306 S *	5/1993	Poisson et al.	D19/48
D336,517 S *	6/1993	McKeown	D24/133

(Continued)

OTHER PUBLICATIONS

Multifunctional Pen, #3018A, as shown on www.jaguarpen.com, dated Feb. 6, 2007 (1 page).*

(Continued)

Primary Examiner—Elizabeth A. Albert

Assistant Examiner—Karen E Eldridge Powers

(74) *Attorney, Agent, or Firm*—Christensen O'Connor Johnson Kindness PLLC

(57) **CLAIM**

The ornamental design for a pen, as shown and described.

DESCRIPTION

FIG. 1 is an upper front right perspective view of a pen showing my new design;

FIG. 2 is a left side elevation view of the pen shown in FIG. 1;

FIG. 3 is a top plan view thereof;

FIG. 4 is a front elevation view thereof;

FIG. 5 is a right side elevation view thereof;

FIG. 6 is a bottom plan view thereof; and,

FIG. 7 is a rear elevation view thereof.

The stippling in the drawings represents a texture on the surface of the pen.

1 Claim, 3 Drawing Sheets

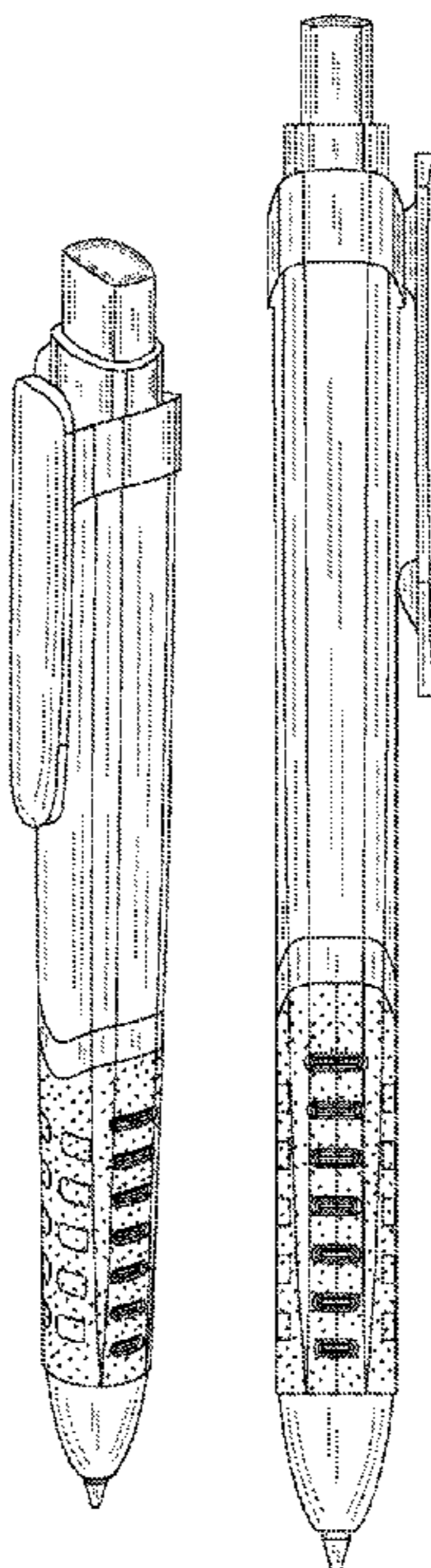

U.S. PATENT DOCUMENTS

D341,200 S * 11/1993 Yoshimoto D24/133
 D341,622 S * 11/1993 Poisson D19/48
 D342,087 S * 12/1993 Mear et al. D19/36
 D342,088 S * 12/1993 Sonntag et al. D19/48
 D351,562 S * 10/1994 Moffatt et al. D10/78
 D385,914 S * 11/1997 Shimizu D19/48
 D394,455 S 5/1998 Izushima
 D397,723 S 9/1998 Izushima
 D402,693 S 12/1998 Sunaga
 D404,070 S 1/1999 Hasegawa
 D408,057 S 4/1999 Izushima
 D410,030 S 5/1999 Sunaga
 D410,682 S 6/1999 Izushima
 D417,891 S 12/1999 Izushima
 D418,163 S 12/1999 Rosen
 D420,702 S * 2/2000 Chang D19/36
 D428,652 S * 7/2000 Frezel et al. D24/152
 D429,526 S * 8/2000 Sullivan et al. D24/133
 D433,704 S 11/2000 Kouda
 D436,996 S 1/2001 Izushima
 D437,352 S 2/2001 Matsuzaki
 D441,017 S 4/2001 Gault
 D442,226 S * 5/2001 Briggel D19/50
 D443,896 S 6/2001 Briggel
 D444,174 S * 6/2001 Izushima D19/48
 D444,498 S 7/2001 Izushima
 D446,243 S 8/2001 Pellissa Beneyto
 D450,768 S * 11/2001 Keda D19/48
 D453,187 S 1/2002 Keda
 D453,790 S 2/2002 Tsuchikura
 D456,845 S 5/2002 Rommel

D463,491 S 9/2002 Hwang
 D464,653 S * 10/2002 Nagai et al. D14/411
 D474,809 S * 5/2003 Willat et al. D19/51
 D478,125 S * 8/2003 Chen D19/50
 D485,574 S * 1/2004 Keil D19/50
 D490,108 S 5/2004 Moon
 D492,350 S 6/2004 Morrow
 D499,139 S 11/2004 Oka
 D499,142 S 11/2004 Morrow
 D506,504 S 6/2005 Nakazawa
 D509,853 S 9/2005 Anand
 D521,556 S 5/2006 Cetera
 D538,853 S * 3/2007 Losel D19/51
 D541,860 S 5/2007 Kung
 D542,843 S 5/2007 Qiu
 D548,281 S * 8/2007 Tien D19/50
 D551,707 S * 9/2007 Neuenschwander et al. .. D19/47
 D559,318 S 1/2008 Qiu
 D562,388 S 2/2008 Qiu
 D562,390 S 2/2008 Qiu
 D562,397 S 2/2008 Qiu
 D562,398 S 2/2008 Qiu
 D563,469 S * 3/2008 Qiu et al. D19/44
 D563,473 S 3/2008 Qiu

OTHER PUBLICATIONS

Li, B., "Pen," U.S. Appl. No. 29/282,456, filed Jul. 20, 2007.
 Fei, Y., "Pen," U.S. Appl. No. 29/284,179, filed Aug. 31, 2007.
 Fei, Y., "Pen," U.S. Appl. No. 29/284,181, filed Aug. 31, 2007.
 Qiu, Z. and Y. Fei, "Pen," U.S. Appl. No. 29/276,672, filed Feb. 1, 2007.

* cited by examiner

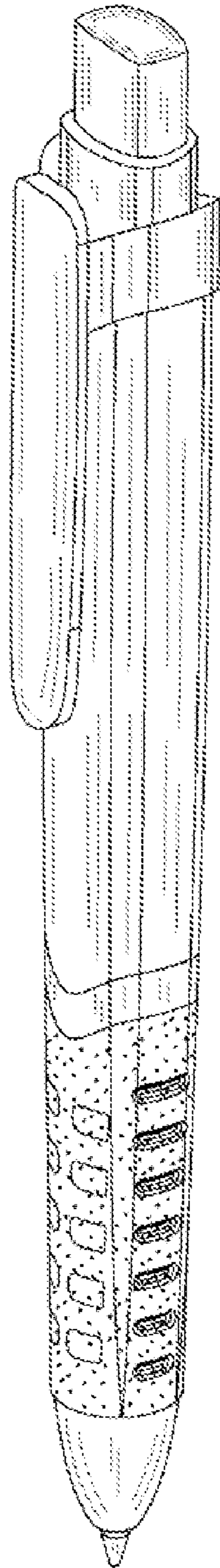

Fig. 1.

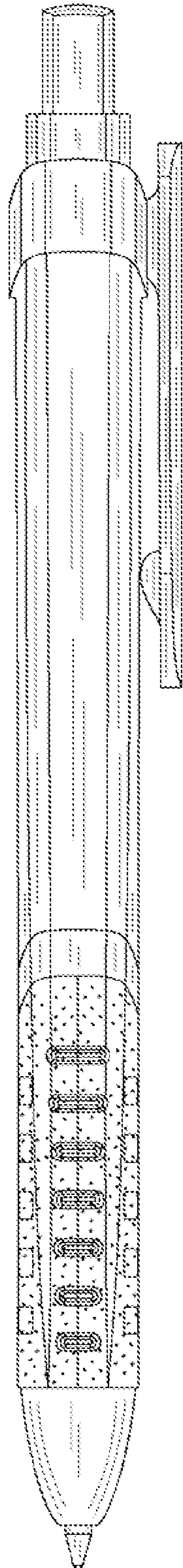

Fig. 2.

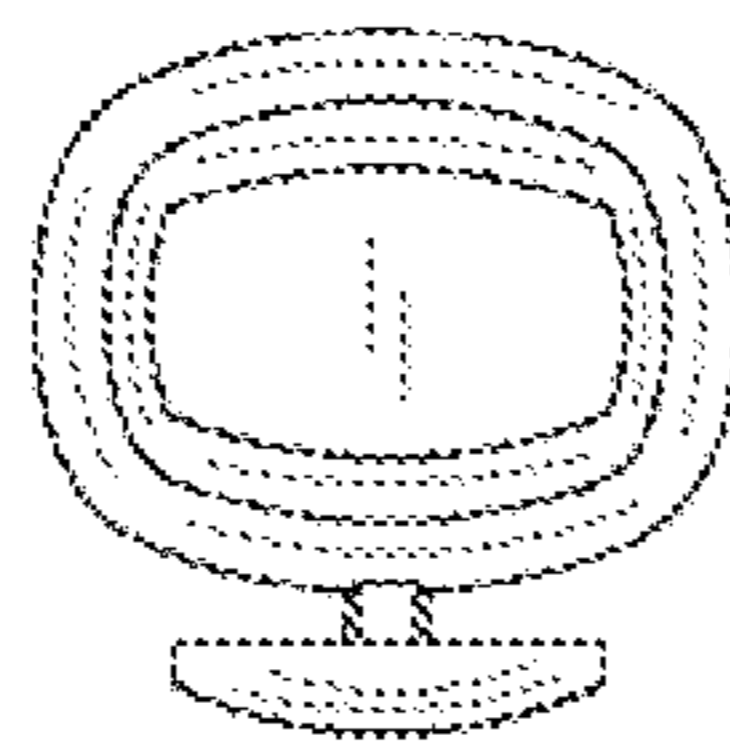

Fig. 3.

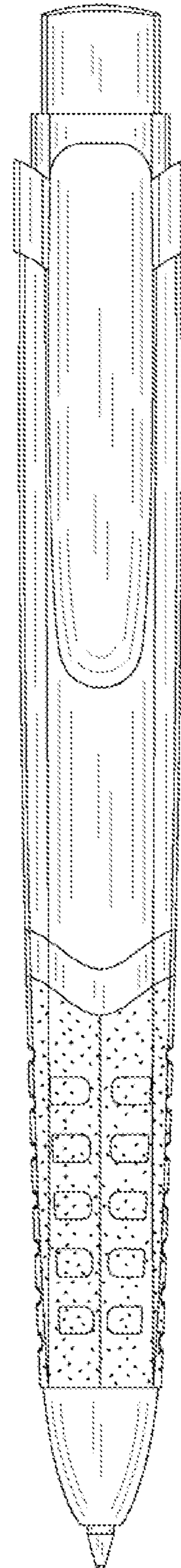

Fig. 4.

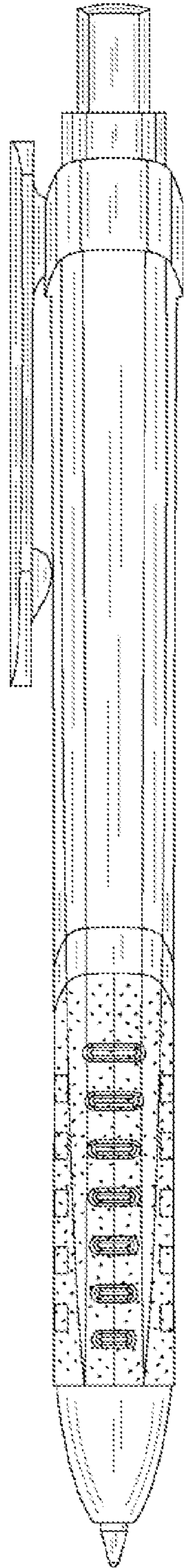

Fig. 5.

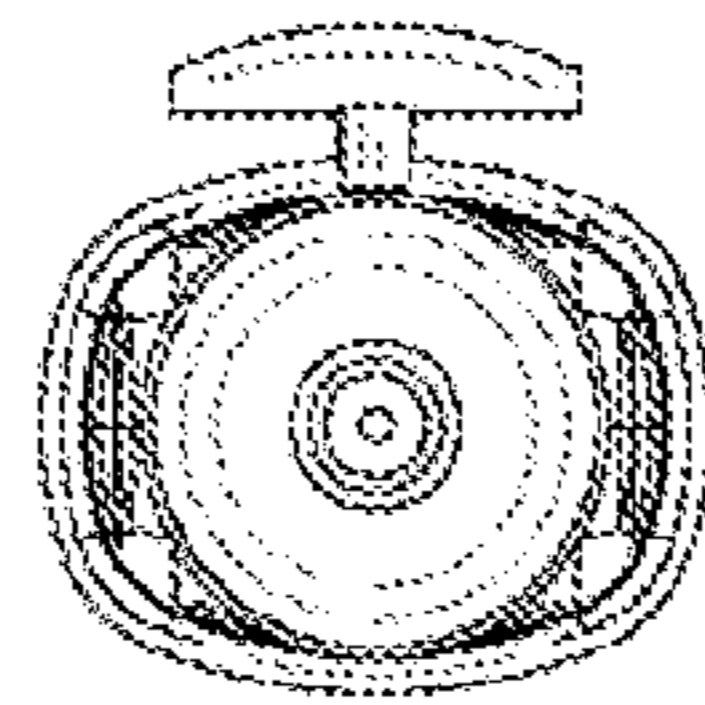

Fig. 6.

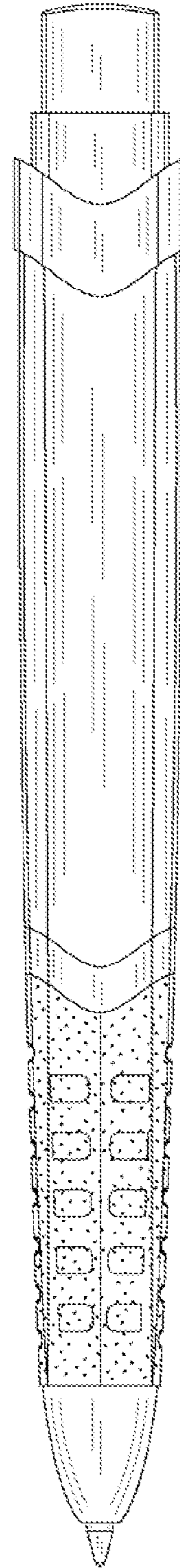

Fig. 7.