



US00D580479S

(12) **United States Design Patent**
Hanazato

(10) **Patent No.:** **US D580,479 S**

(45) **Date of Patent:** **** Nov. 11, 2008**

(54) **COMBINED STAMP AND CAP**

(75) Inventor: **Muneya Hanazato**, Kariya (JP)

(73) Assignee: **Shachihata Inc.**, Nagoya, Aichi (JP)

(**) Term: **14 Years**

(21) Appl. No.: **29/287,429**

(22) Filed: **Aug. 6, 2007**

(30) **Foreign Application Priority Data**

Feb. 6, 2007 (JP) 2007-002679

(51) **LOC (8) Cl.** **19-02**

(52) **U.S. Cl.** **D18/15**

(58) **Field of Classification Search** D18/14-21;
101/334, 327-328, 405, 352.07, DIG. 30;
118/264, 268; D5/4-6, 20-25, 62; 164/45
See application file for complete search history.

(56) **References Cited**

U.S. PATENT DOCUMENTS

4,803 A *	10/1846	Waters	164/45
D145,514 S *	9/1946	Duke	D18/15
D209,874 S *	1/1968	Anderson	D18/15
3,363,548 A *	1/1968	Aijima	101/83
D214,534 S *	6/1969	Anderson	D18/15
D233,174 S *	10/1974	Funahashi	D18/15
D236,752 S *	9/1975	Funahashi	D18/15
5,058,264 A *	10/1991	Quach	D18/15
D399,245 S *	10/1998	Harden	D18/15
D446,805 S *	8/2001	Suto	D18/15
D477,628 S *	7/2003	Zambelli et al.	D18/15
D478,930 S *	8/2003	Zambelli et al.	D18/15
D506,775 S *	6/2005	Kida et al.	D18/15

FOREIGN PATENT DOCUMENTS

JP	399843	3/1950
JP	1031838	11/1998
JP	1044487	4/1999

* cited by examiner

Primary Examiner—Charles A. Rademaker

(74) *Attorney, Agent, or Firm*—Jacobson Holman PLLC

(57) **CLAIM**

The ornamental design for a combined stamp and cap, as shown and described.

DESCRIPTION

FIG. 1 is a front perspective view of a combined stamp and cap showing my new design;

FIG. 2 is a front elevation thereof;

FIG. 3 is a rear elevation thereof;

FIG. 4 is a right side elevation thereof;

FIG. 5 is a left side elevation thereof;

FIG. 6 is a top plan view thereof;

FIG. 7 is a bottom plan view thereof;

FIG. 8 is a cross-section thereof taken along line 8—8 in FIG. 6;

FIG. 9 is a cross-section thereof taken along line 9—9 in FIG. 6;

FIG. 10 is a front elevation thereof of the body of the design with the cap removed;

FIG. 11 is a front elevation thereof;

FIG. 12 is a right side elevation thereof;

FIG. 13 is a left side elevation thereof;

FIG. 14 is a top plan view thereof;

FIG. 15 is a bottom plan view thereof;

FIG. 16 is a front elevation of the cap member;

FIG. 17 is a rear elevation thereof;

FIG. 18 is a right side elevation thereof;

FIG. 19 is a left side elevation thereof;

FIG. 20 is a top plan view thereof; and,

FIG. 21 is a bottom plan view thereof.

1 Claim, 3 Drawing Sheets

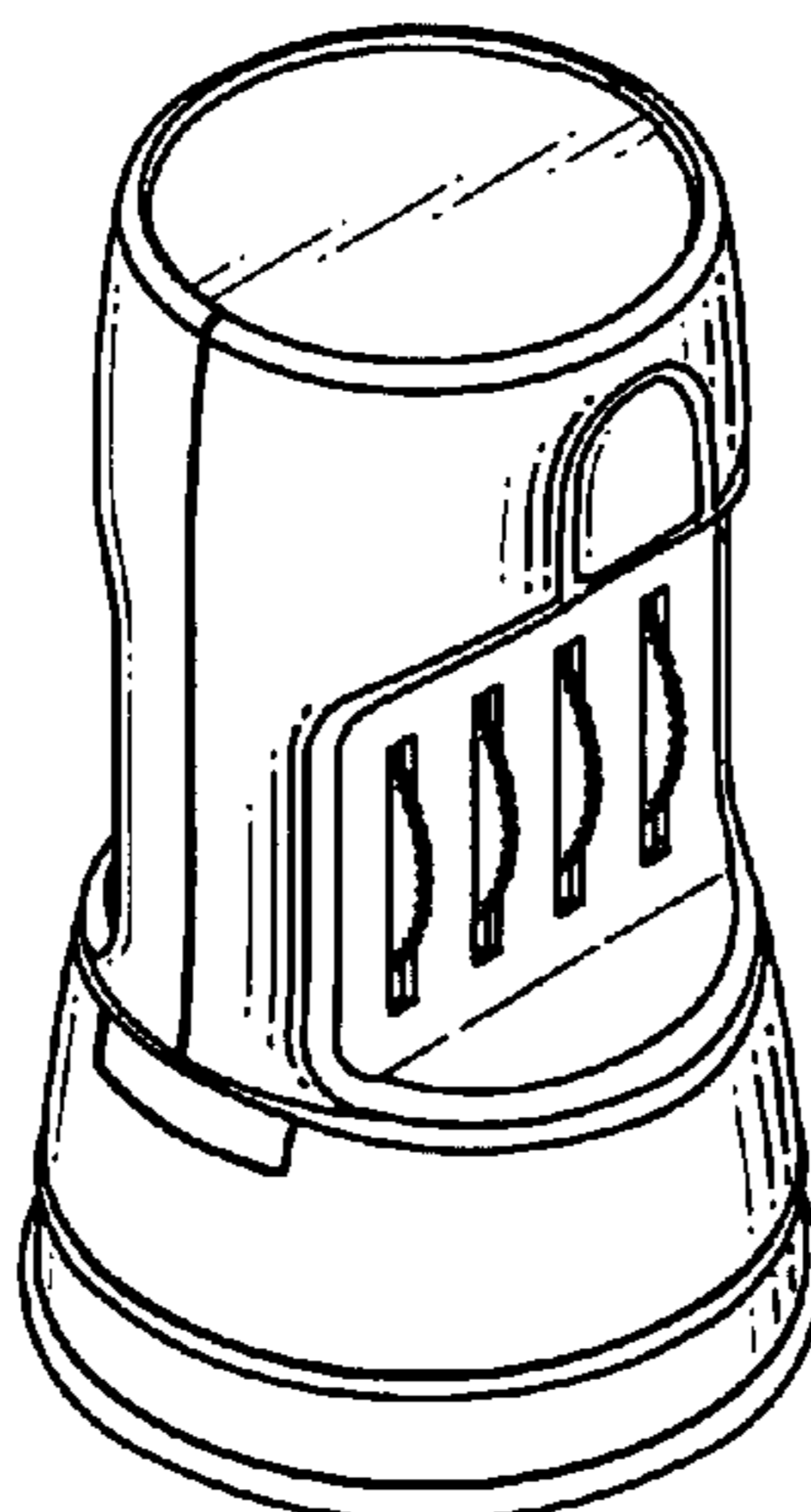

FIG.1

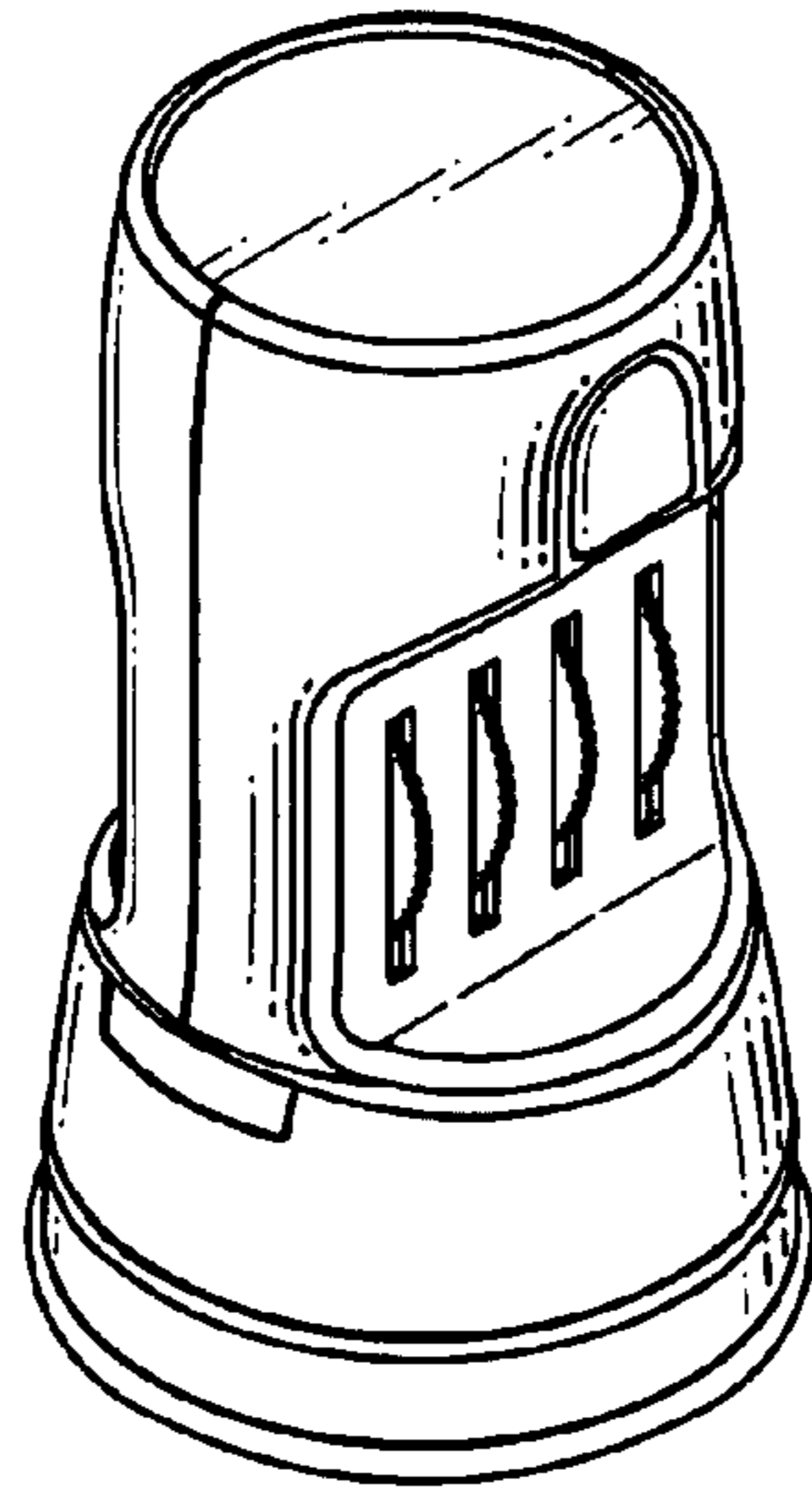

FIG.2

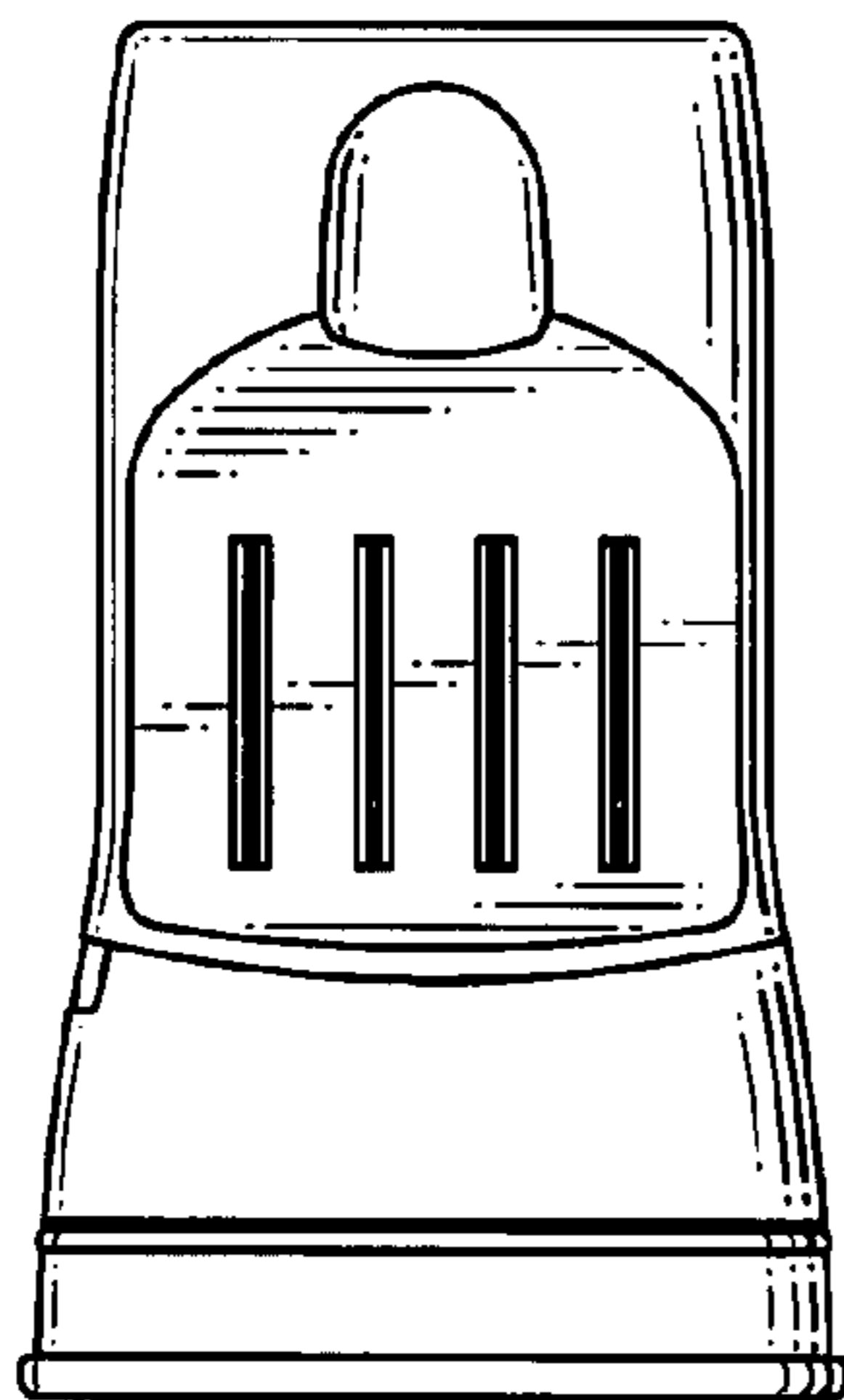

FIG.3

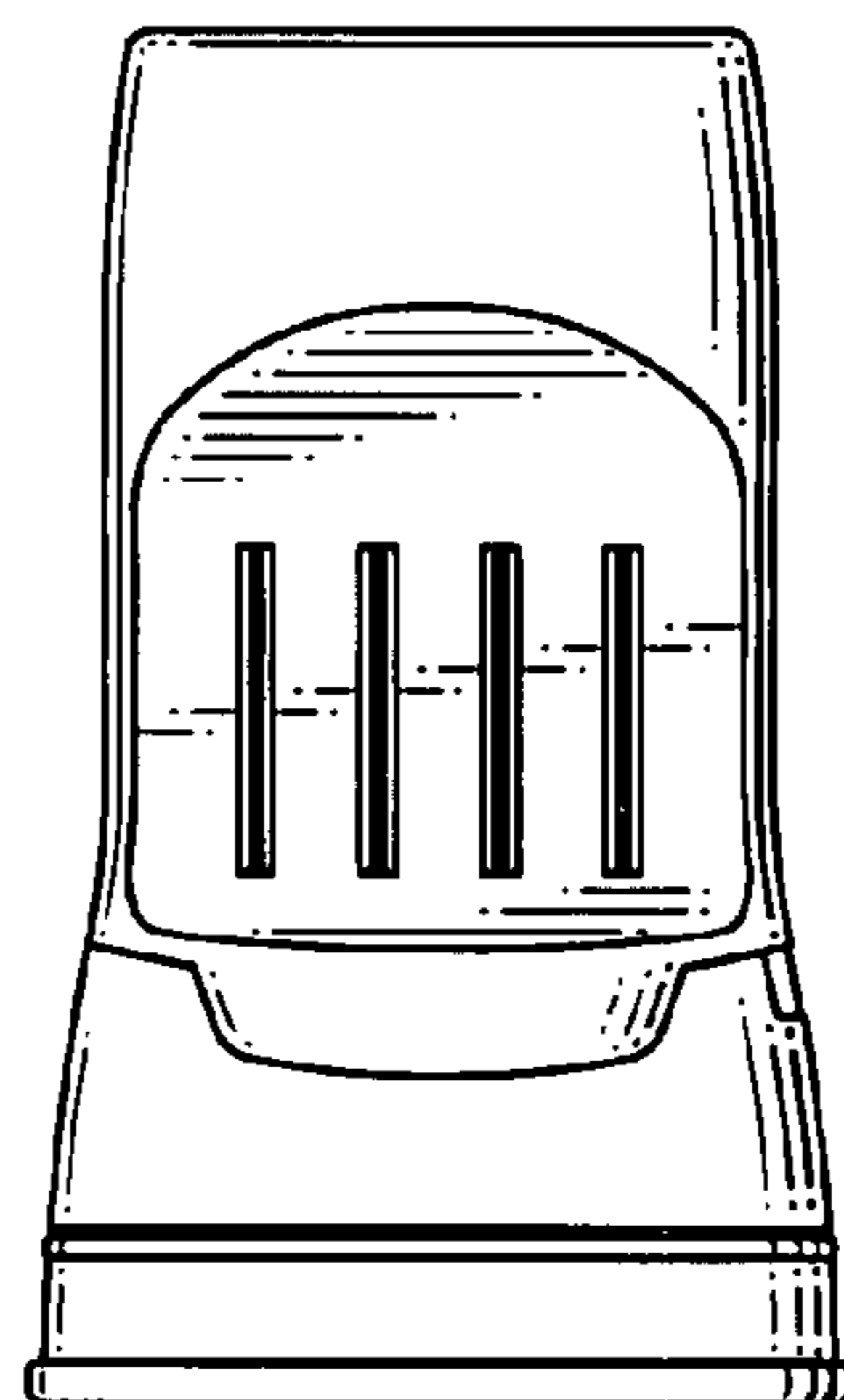

FIG.4

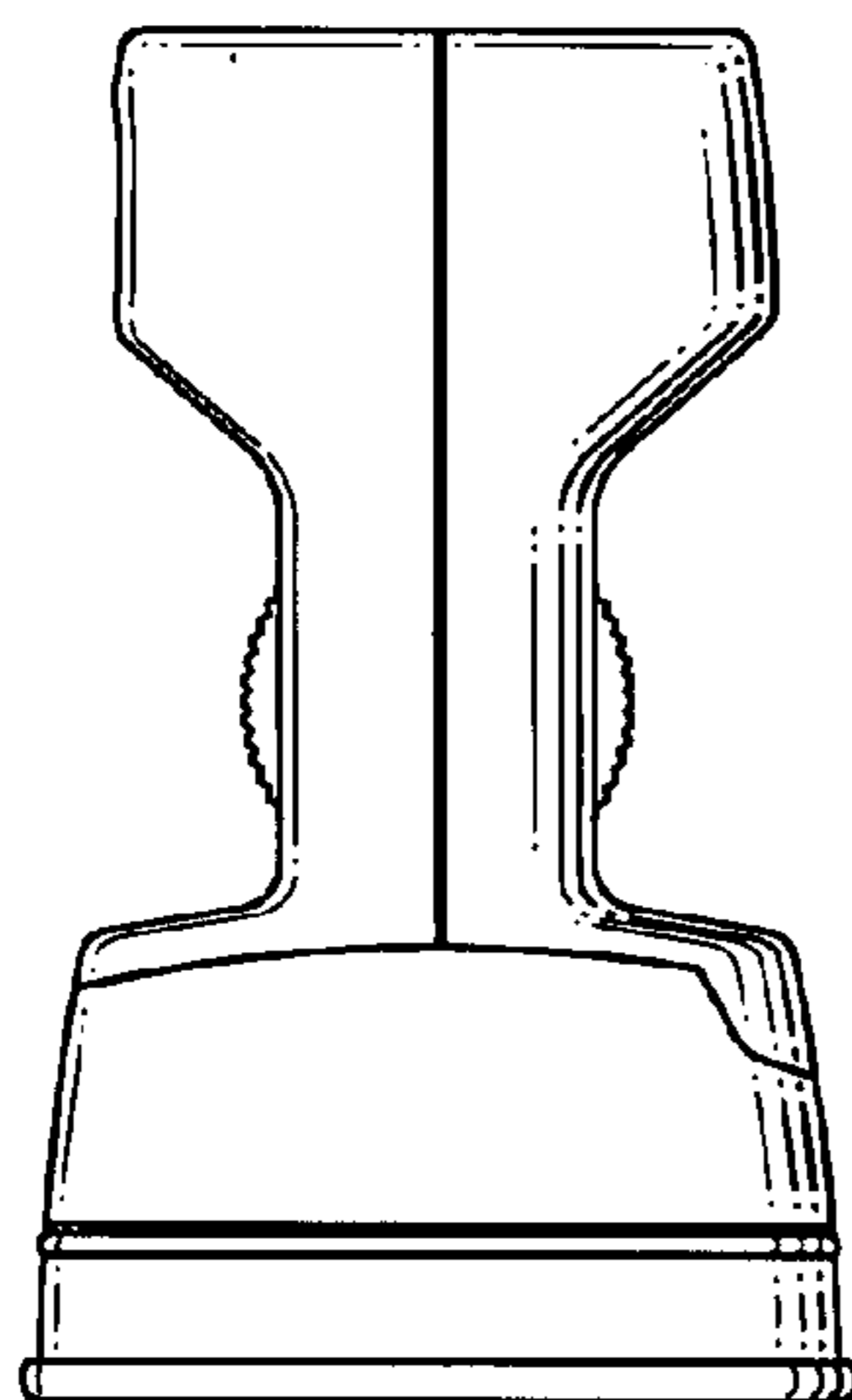

FIG.5

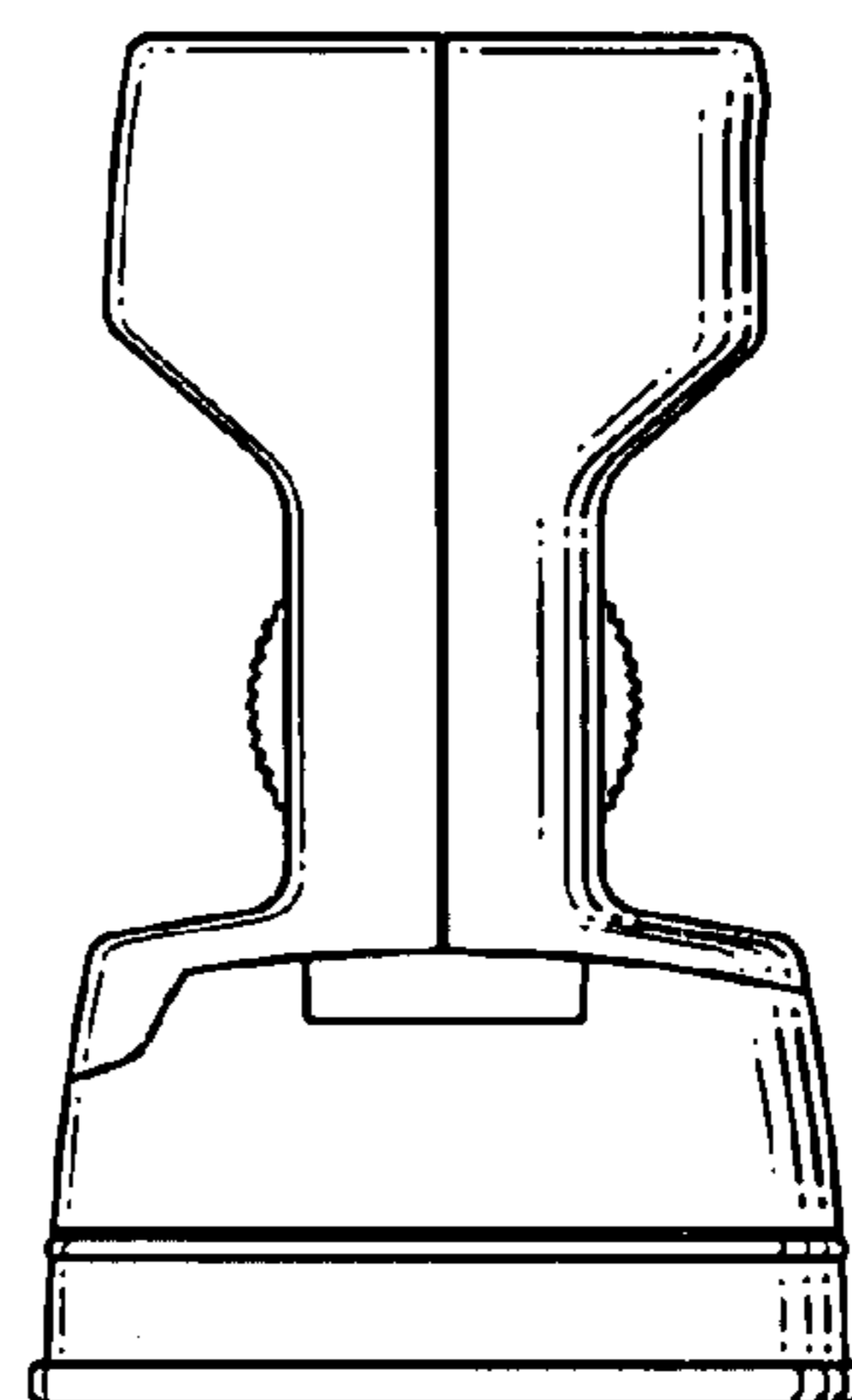

FIG.6

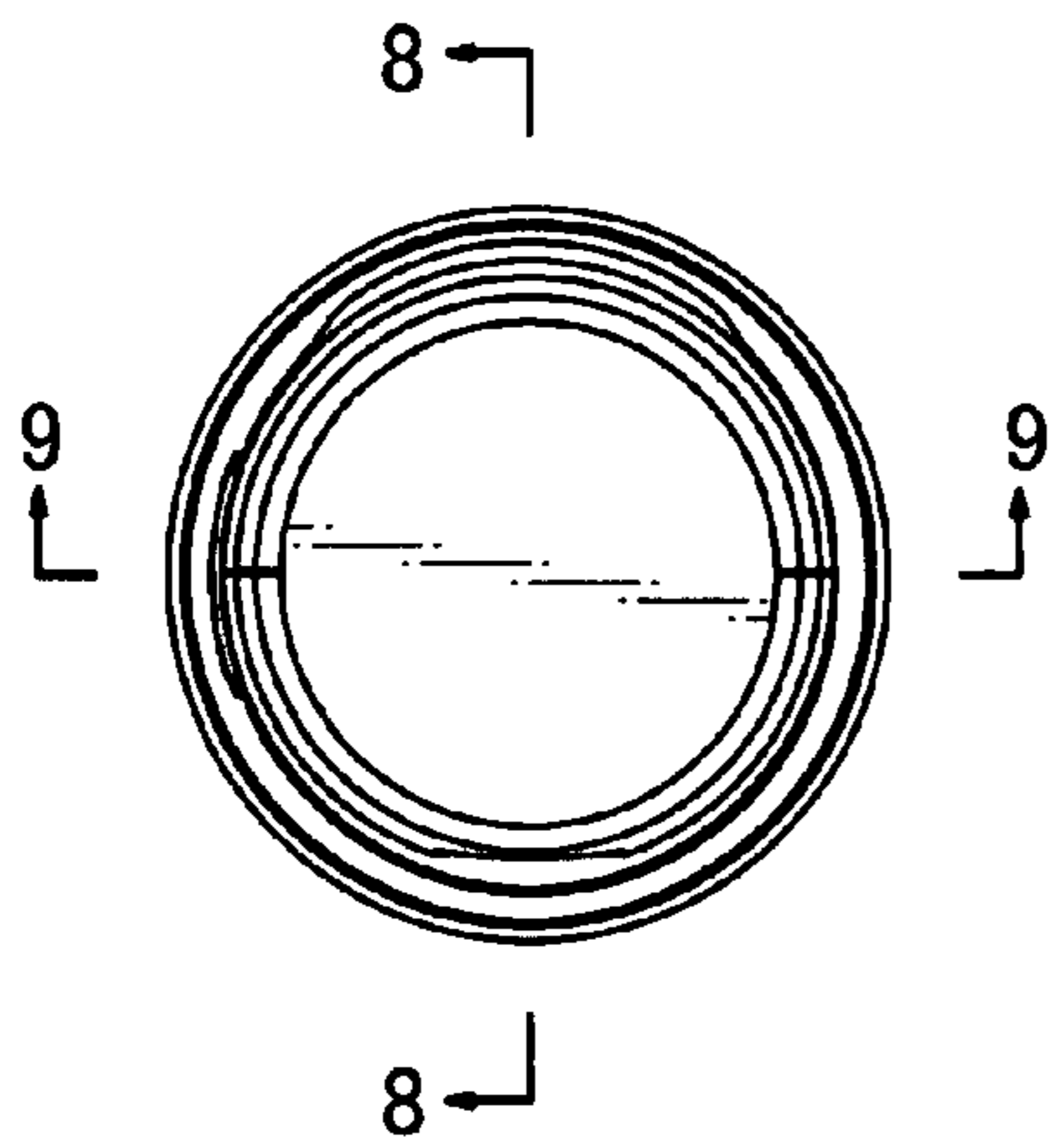

FIG.7

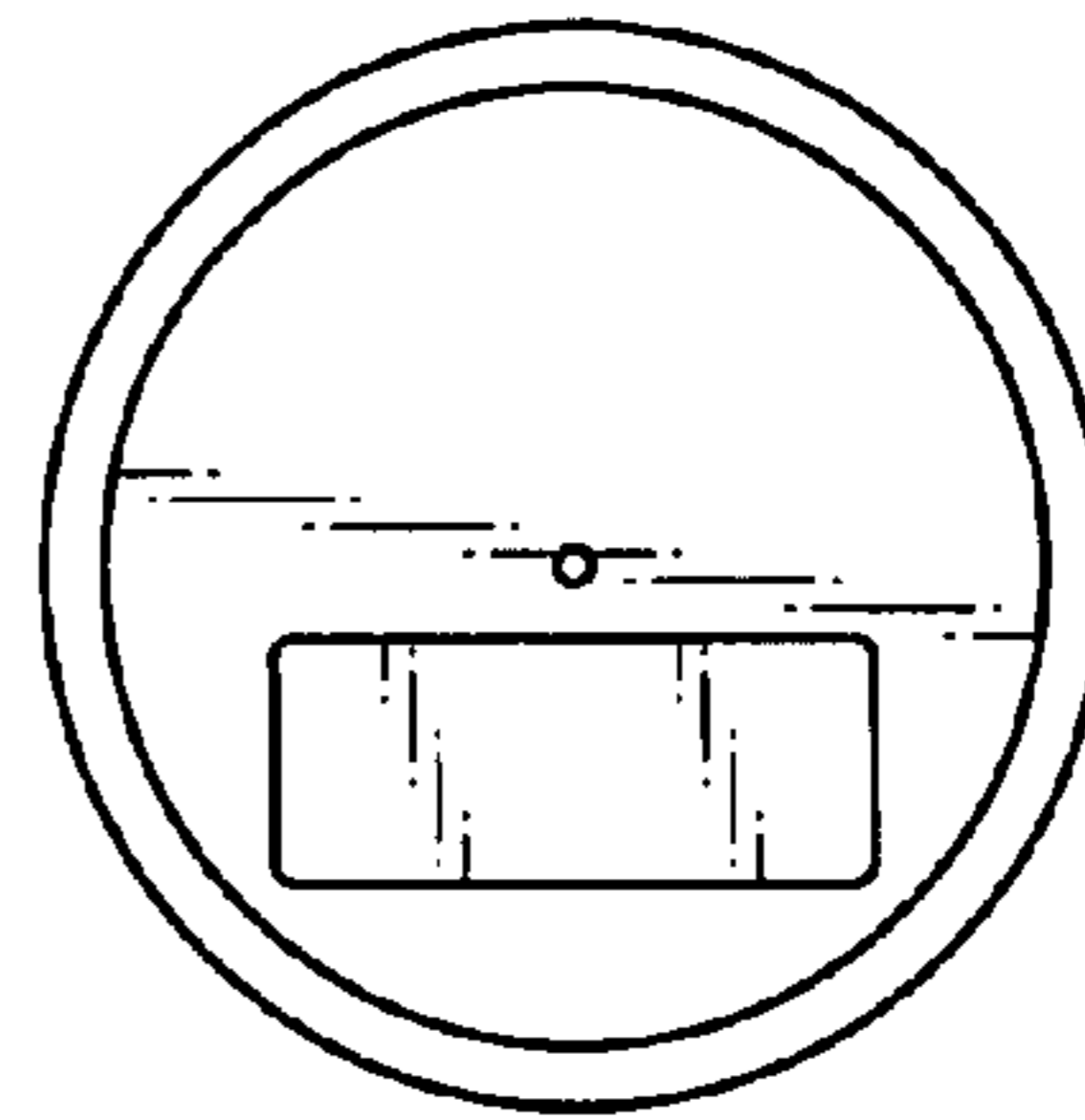

FIG.8

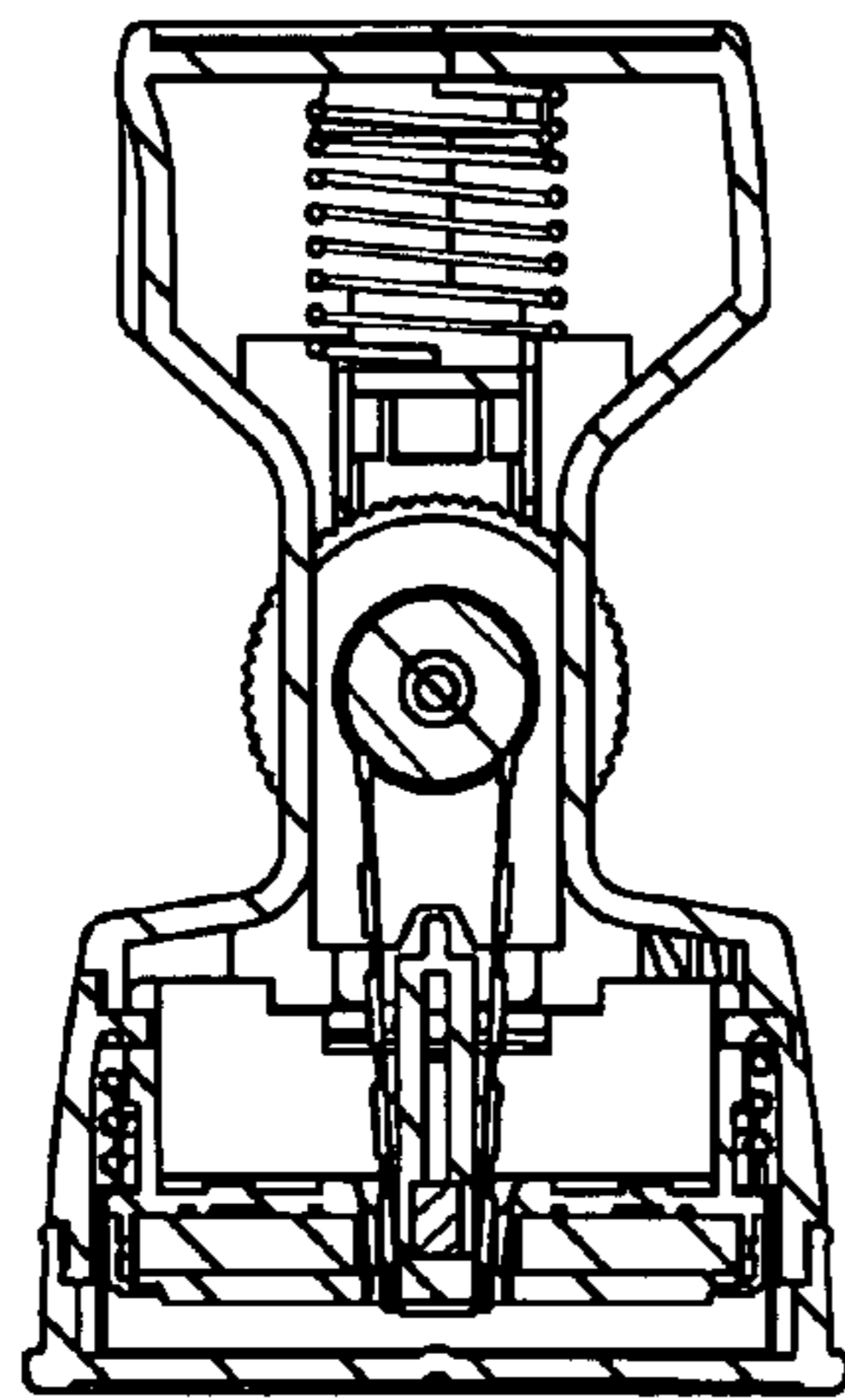

FIG.9

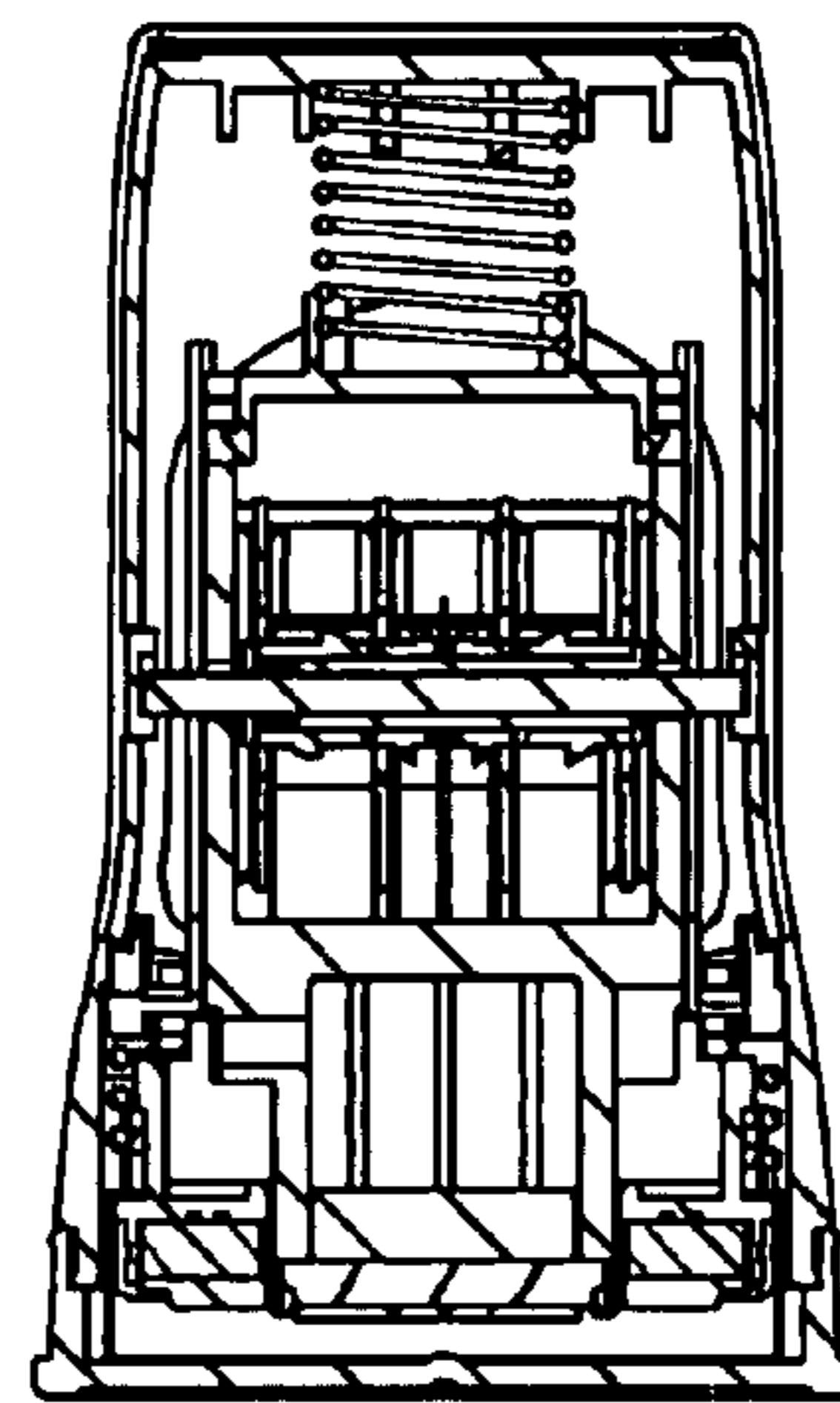

FIG.10

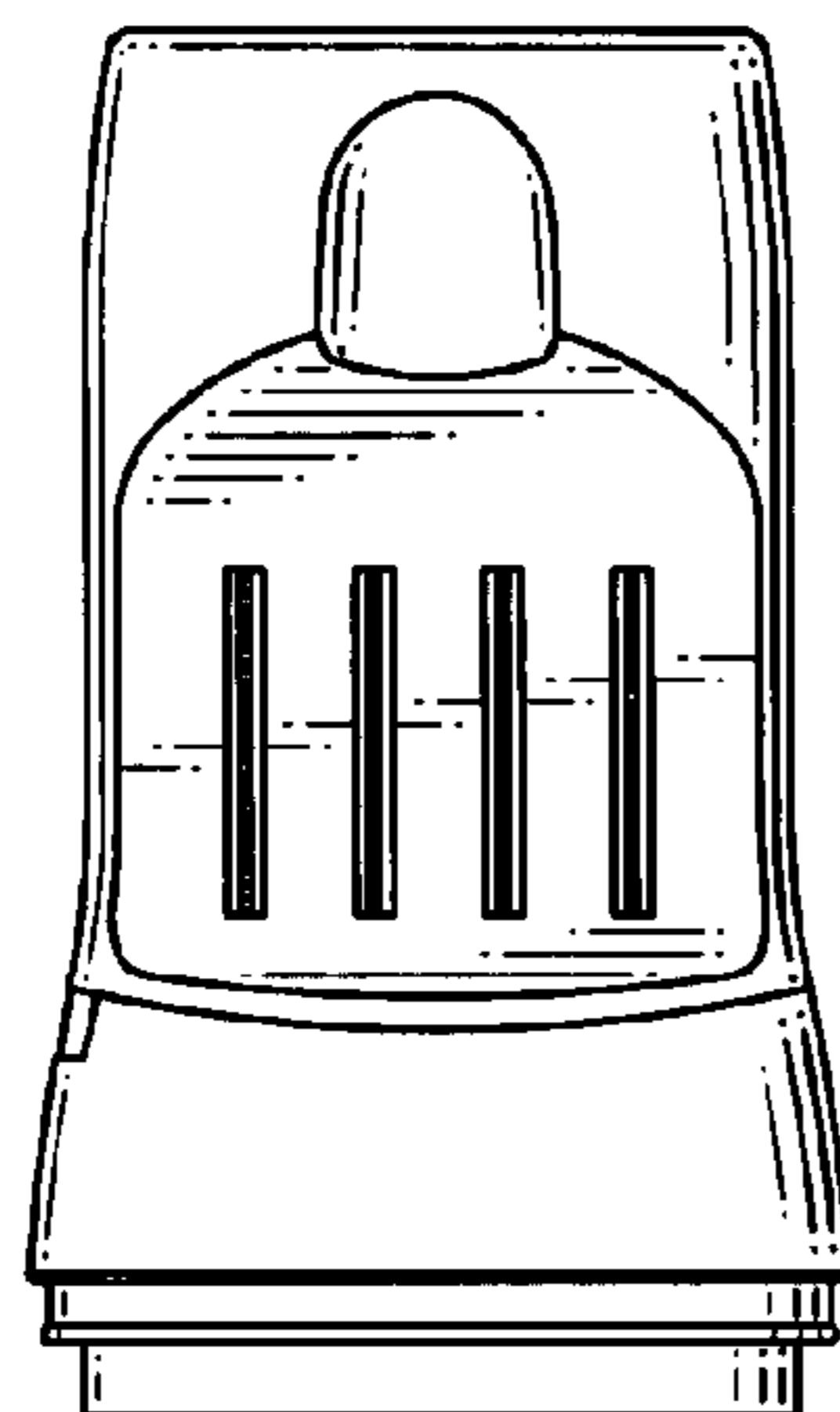

FIG.11

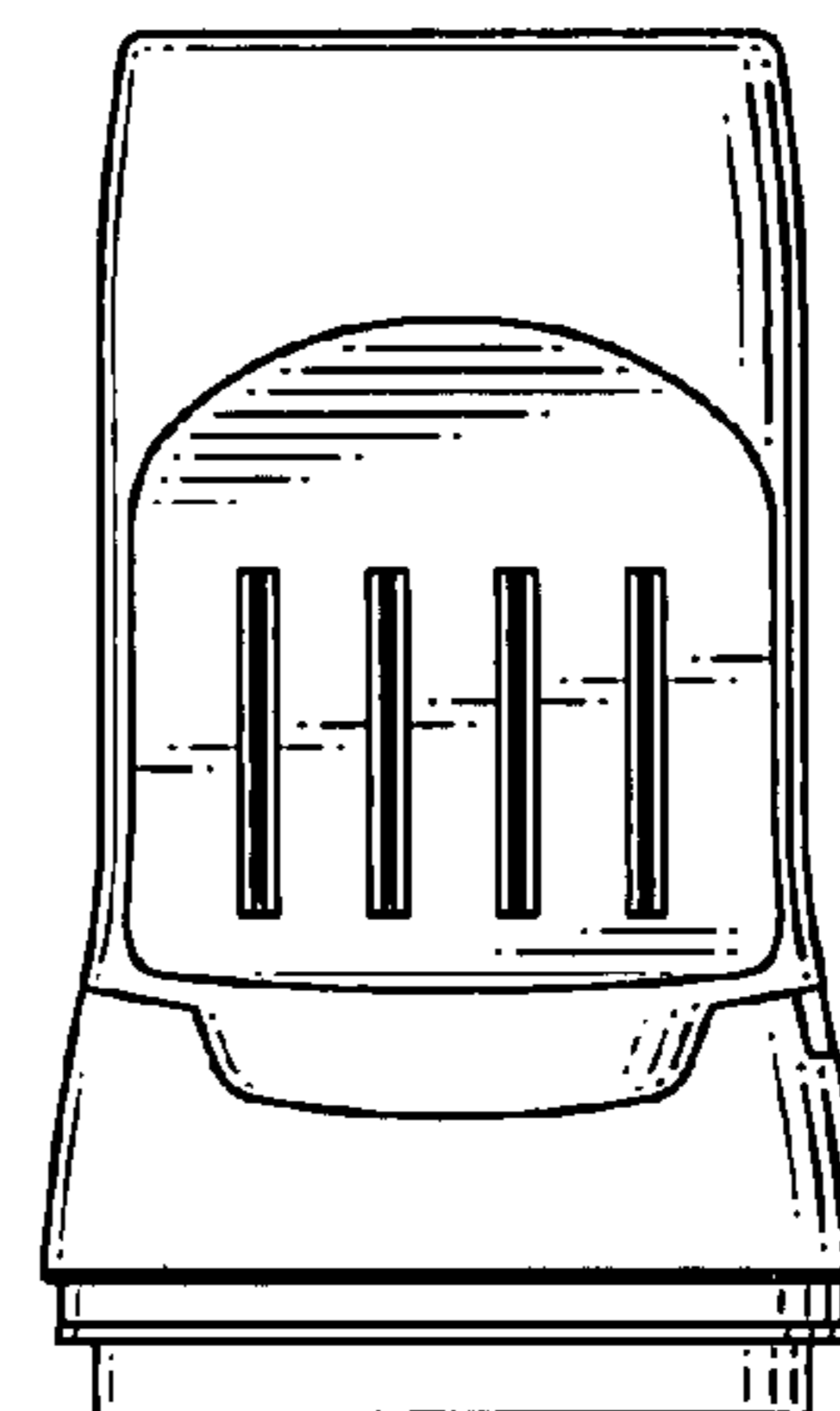

FIG.12

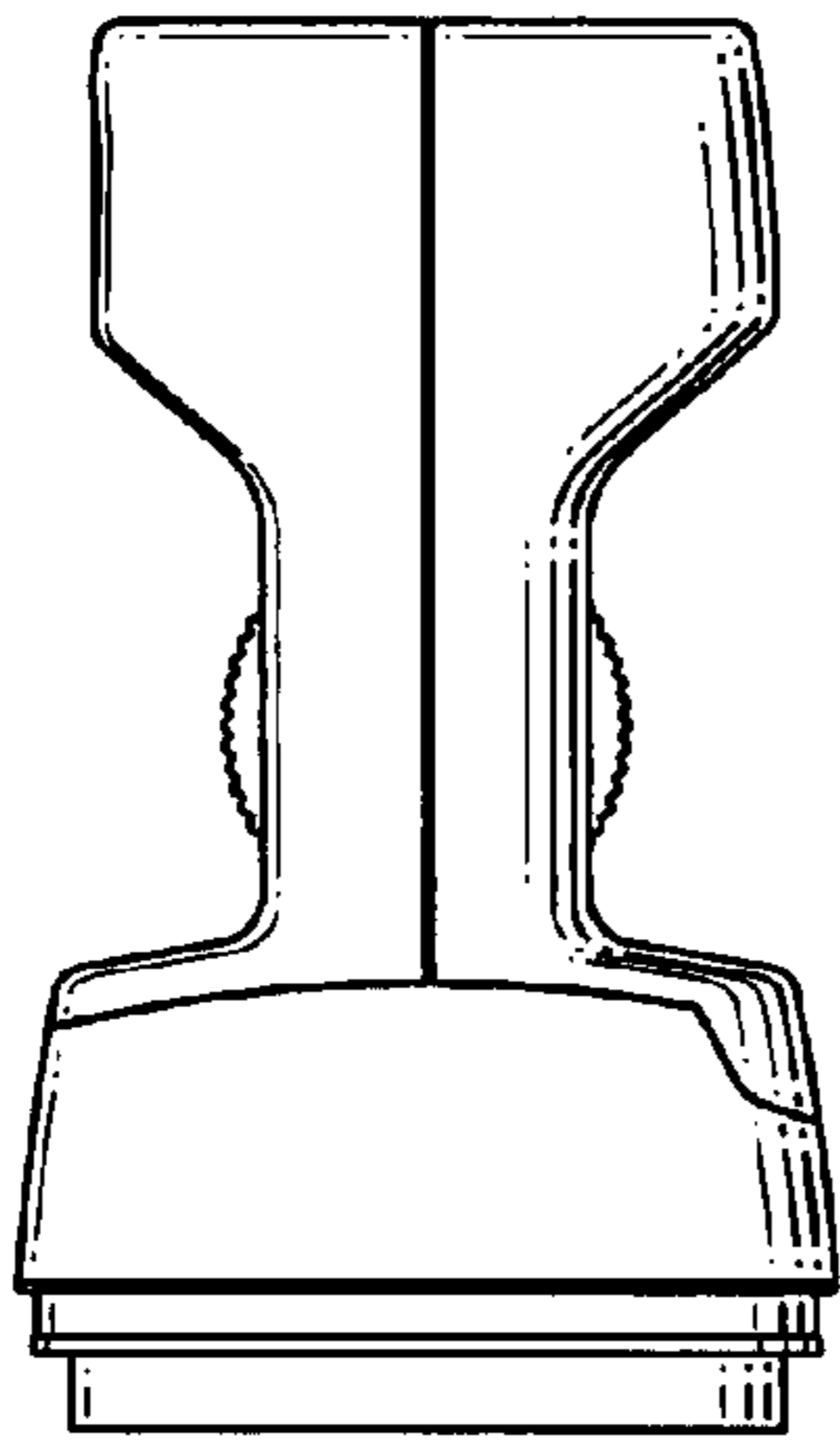

FIG.13

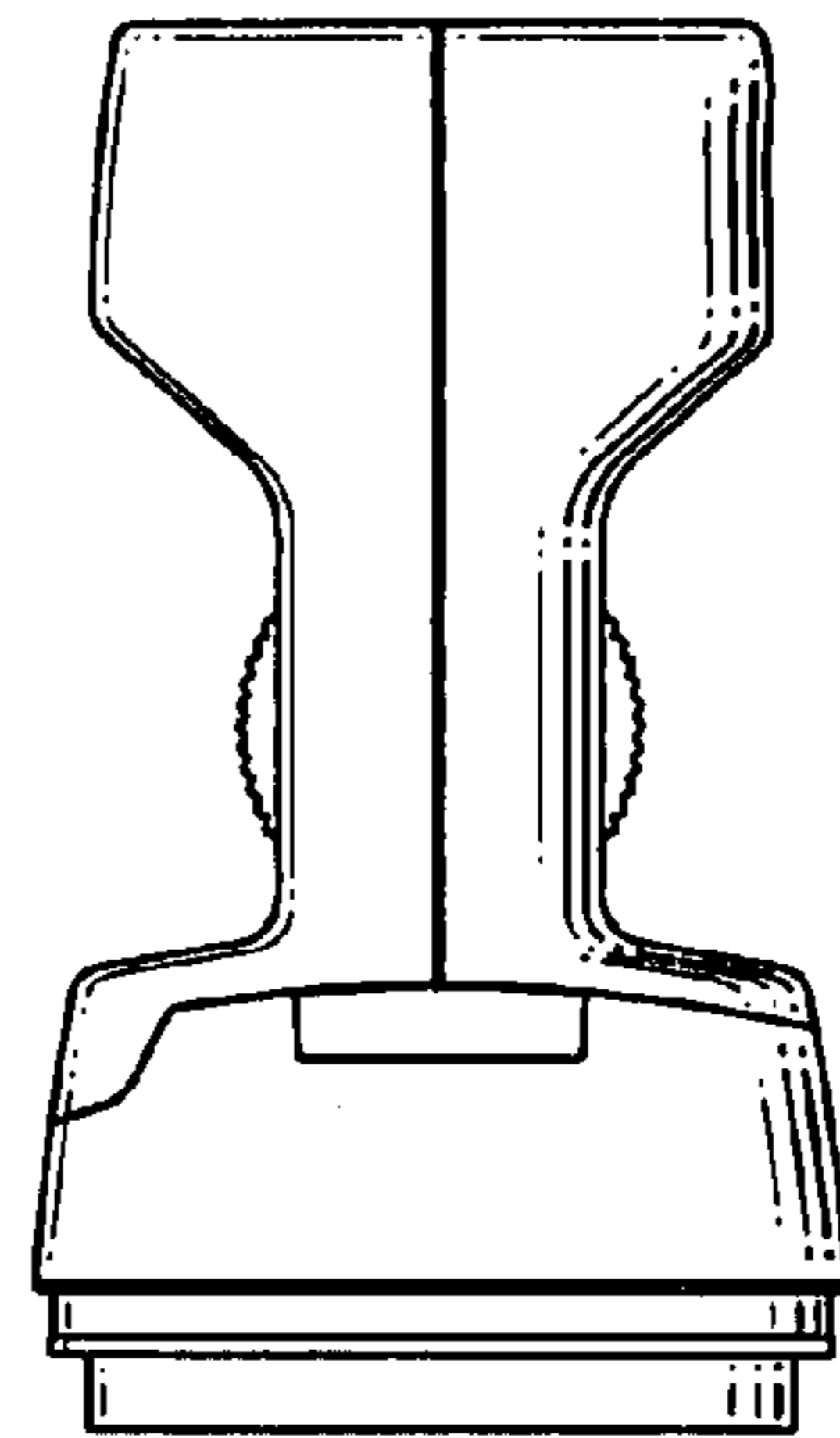

FIG.14

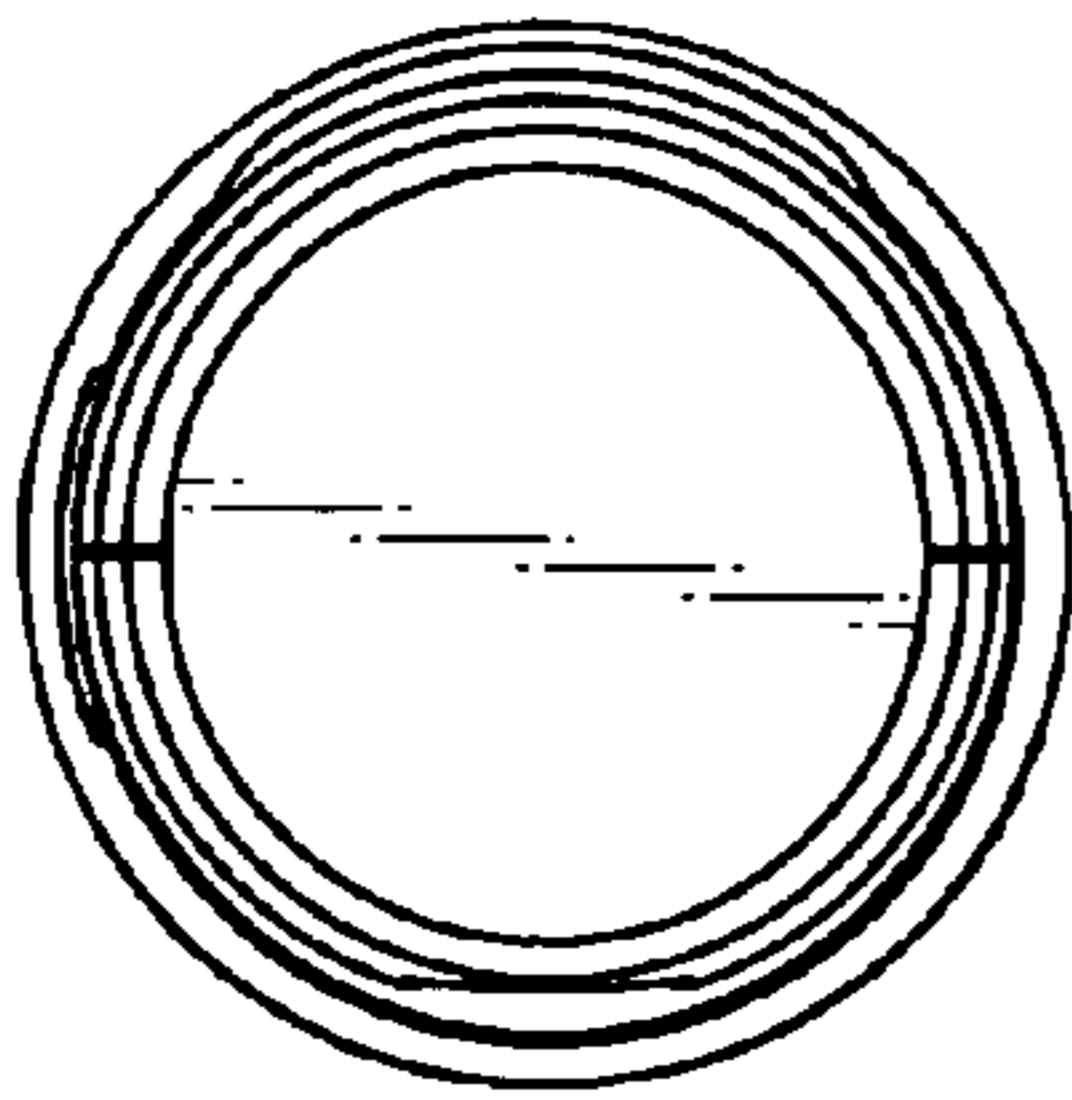

FIG.15

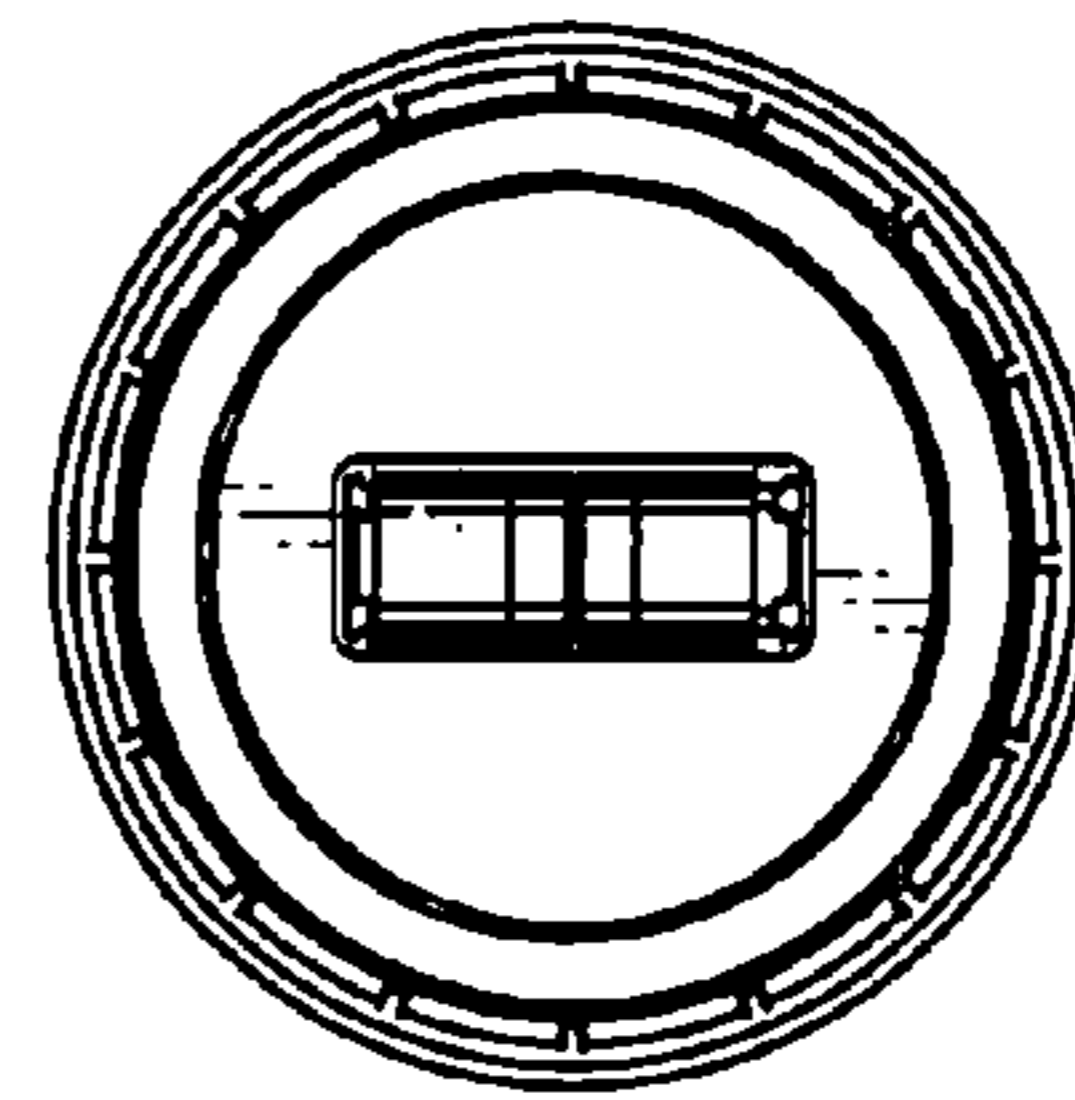

FIG.16



FIG.17

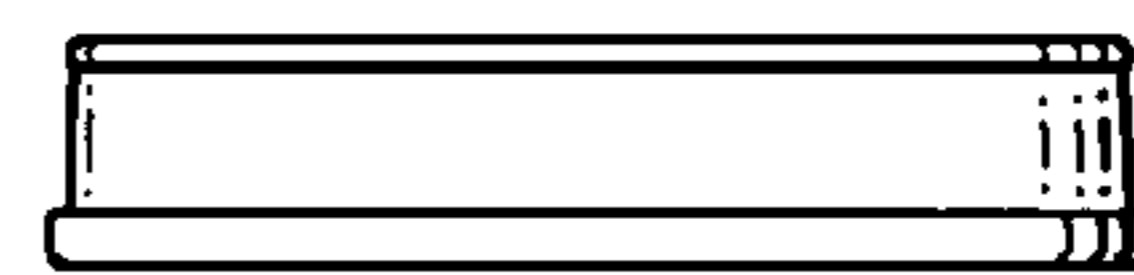

FIG.18

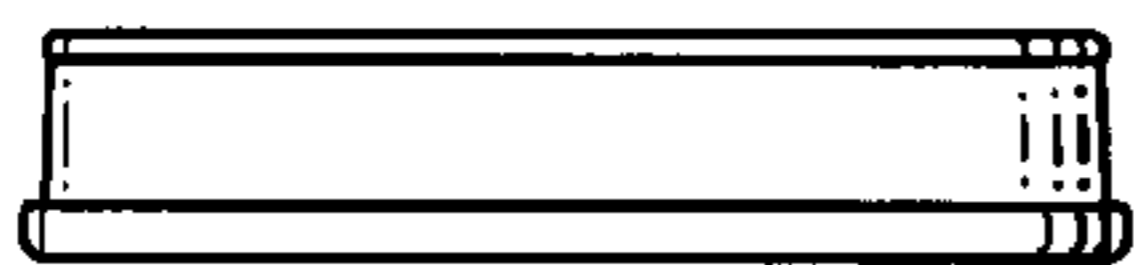

FIG.19

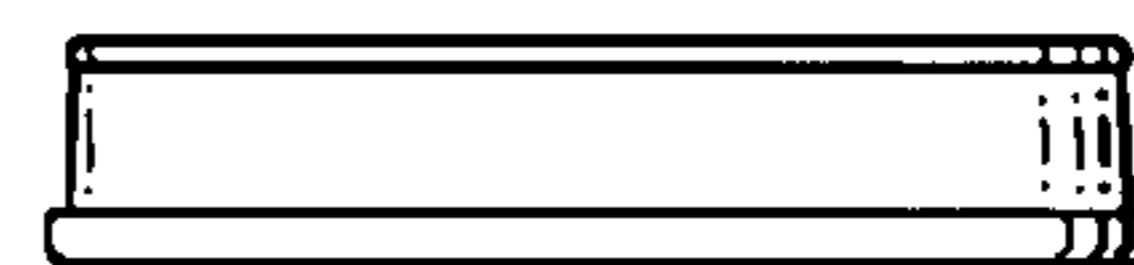

FIG.20

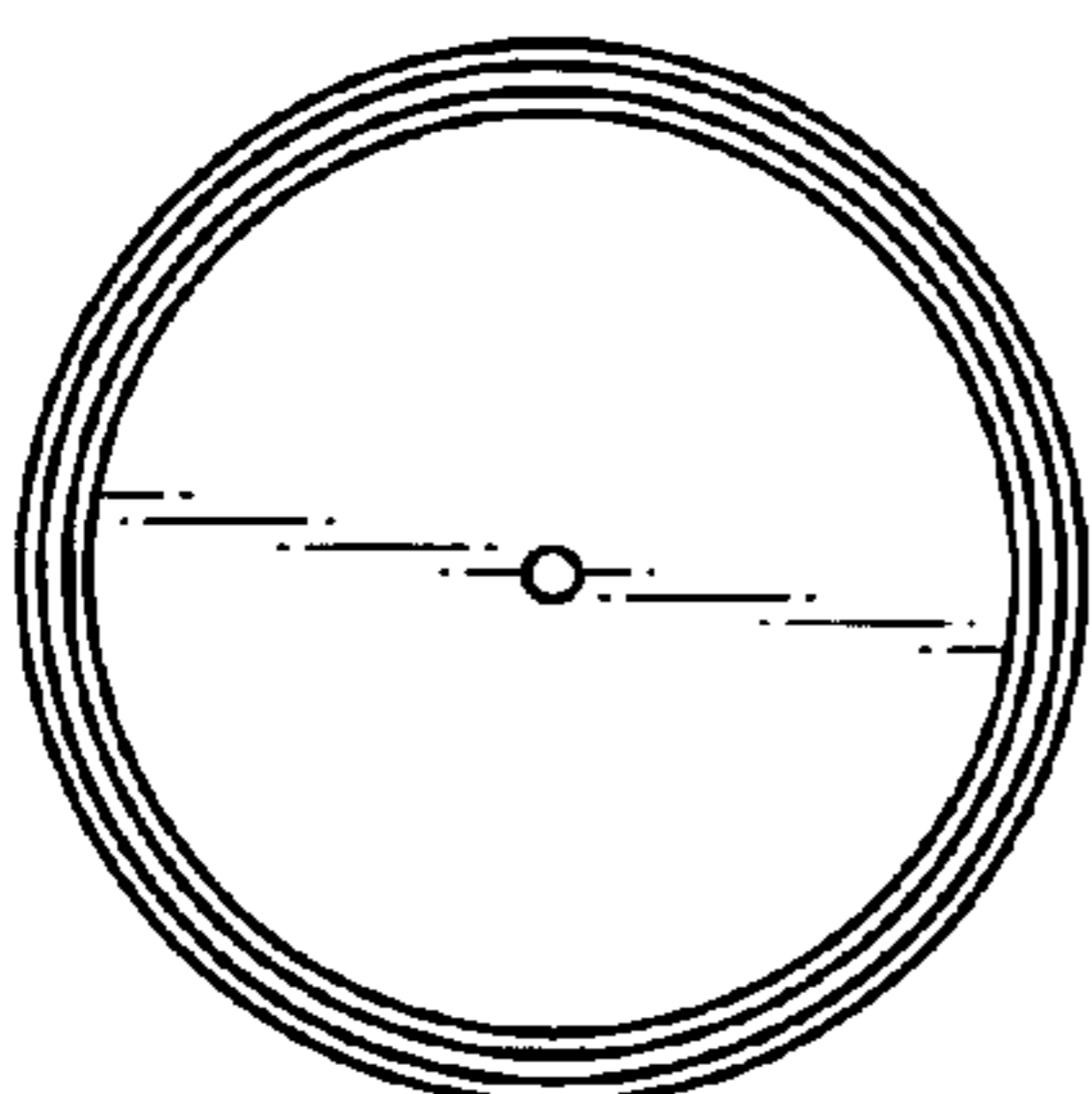

FIG.21

