



US00D580388S

(12) **United States Design Patent**
Kim et al.

(10) **Patent No.:** **US D580,388 S**
(45) **Date of Patent:** **** Nov. 11, 2008**

(54) **MOBILE PHONE**

(75) Inventors: **Nam-Su Kim**, Seoul (KR); **Min-Hyouk Lee**, Seoul (KR); **Chang-Hwan Hwang**, Goyang-si (KR)

(73) Assignee: **Samsung Electronics Co., Ltd.**, Suwon-Si (KR)

(**) Term: **14 Years**

(21) Appl. No.: **29/272,971**

(22) Filed: **Feb. 23, 2007**

(30) **Foreign Application Priority Data**

Dec. 13, 2006 (KR) 30-2006-0049559

(51) **LOC (8) Cl.** **14-03**

(52) **U.S. Cl.** **D14/138**

(58) **Field of Classification Search** D14/138,
D14/496, 341-347; 455/575.3, 575.1
See application file for complete search history.

(56) **References Cited**

U.S. PATENT DOCUMENTS

D541,780	S	*	5/2007	Park et al.	D14/138
D545,797	S	*	7/2007	Yang et al.	D14/138
7,239,289	B2	*	7/2007	Kim	343/860
D549,679	S	*	8/2007	Park et al.	D14/138
D556,722	S	*	12/2007	Kim et al.	D14/138
D557,669	S	*	12/2007	Kim et al.	D14/138
D558,169	S	*	12/2007	Chung et al.	D14/138
D563,349	S	*	3/2008	Kim et al.	D14/138
D563,350	S	*	3/2008	Oh et al.	D14/138
D563,357	S	*	3/2008	Lee et al.	D14/138
D563,360	S	*	3/2008	Baik et al.	D14/138
D563,361	S	*	3/2008	Moon et al.	D14/138
D563,932	S	*	3/2008	Song et al.	D14/138
D564,489	S	*	3/2008	Hong et al.	D14/138
D565,010	S	*	3/2008	Baik et al.	D14/138

D565,013	S	*	3/2008	Suk et al.	D14/138
D567,789	S	*	4/2008	Lee et al.	D14/138
D568,853	S	*	5/2008	Lee et al.	D14/138
D569,827	S	*	5/2008	Lee et al.	D14/138
D569,828	S	*	5/2008	Lee et al.	D14/138
D571,329	S	*	6/2008	Lee et al.	D14/138
D571,335	S	*	6/2008	Lee et al.	D14/138
D571,336	S	*	6/2008	Lee et al.	D14/138
D571,338	S	*	6/2008	Yoon	D14/138
D571,764	S	*	6/2008	Baik et al.	D14/138
D572,689	S	*	7/2008	Park et al.	D14/138

OTHER PUBLICATIONS

Samsung J400 telephone, announced Jan. 2008, [online], [site visited Jul. 19, 2008]. Available from Internet, <URL: <http://www.gsmarena.com>>.*

(Continued)

Primary Examiner—Jeffrey D Asch

(74) *Attorney, Agent, or Firm*—Staas & Halsey LLP

(57) **CLAIM**

The ornamental design for a mobile phone, as shown and described.

DESCRIPTION

FIG. 1 is a perspective view of a mobile phone;
FIG. 2 is a front view of the mobile phone of FIG. 1;
FIG. 3 is a rear view of the mobile phone of FIG. 1;
FIG. 4 is a left-side view of the mobile phone of FIG. 1;
FIG. 5 is a right-side view of the mobile phone of FIG. 1;
FIG. 6 is a top plan view of the mobile phone of FIG. 1;
FIG. 7 is a bottom plan view of the mobile phone of FIG. 1;
and,
FIG. 8 is an open perspective view of the mobile phone of FIG. 1.

1 Claim, 5 Drawing Sheets

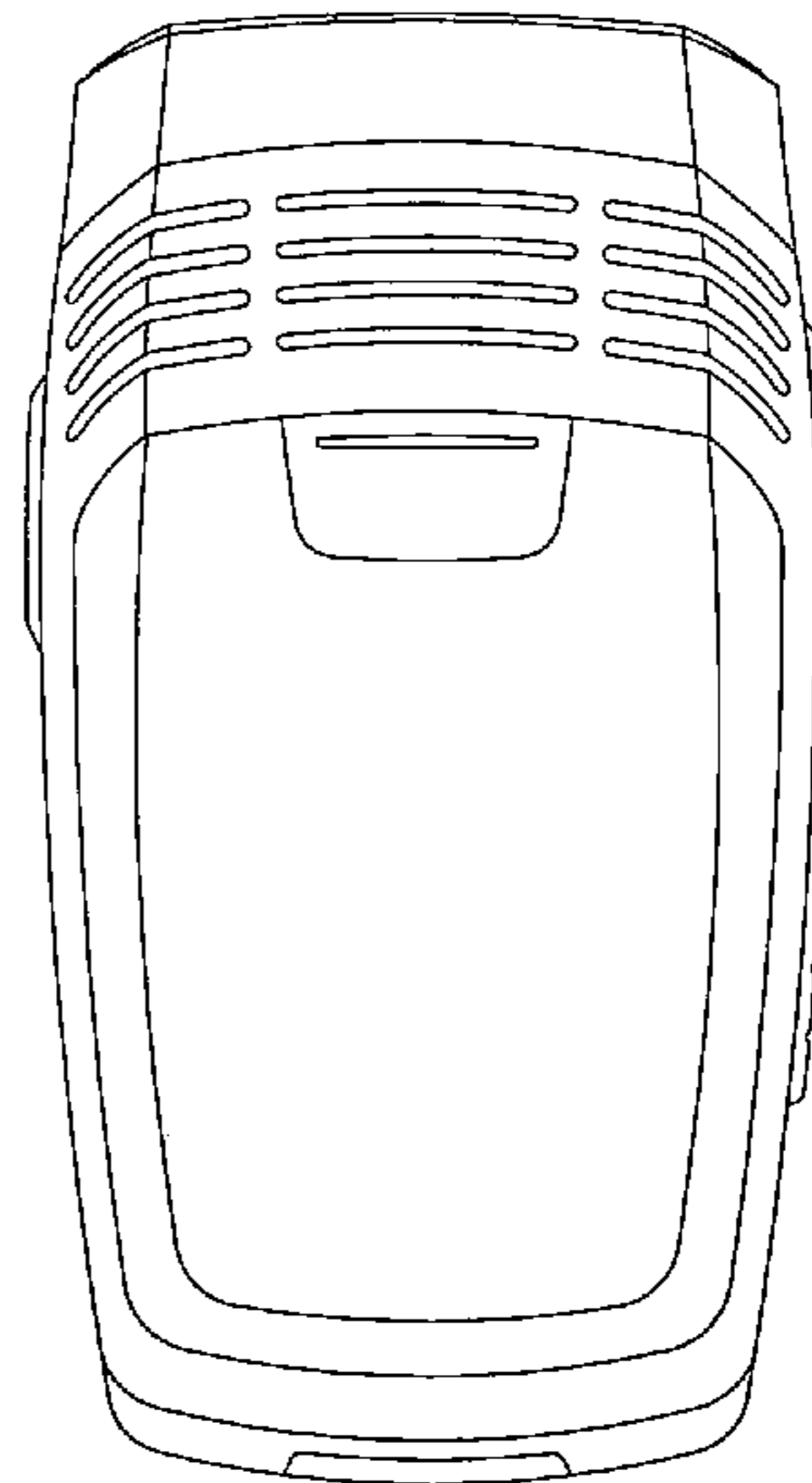
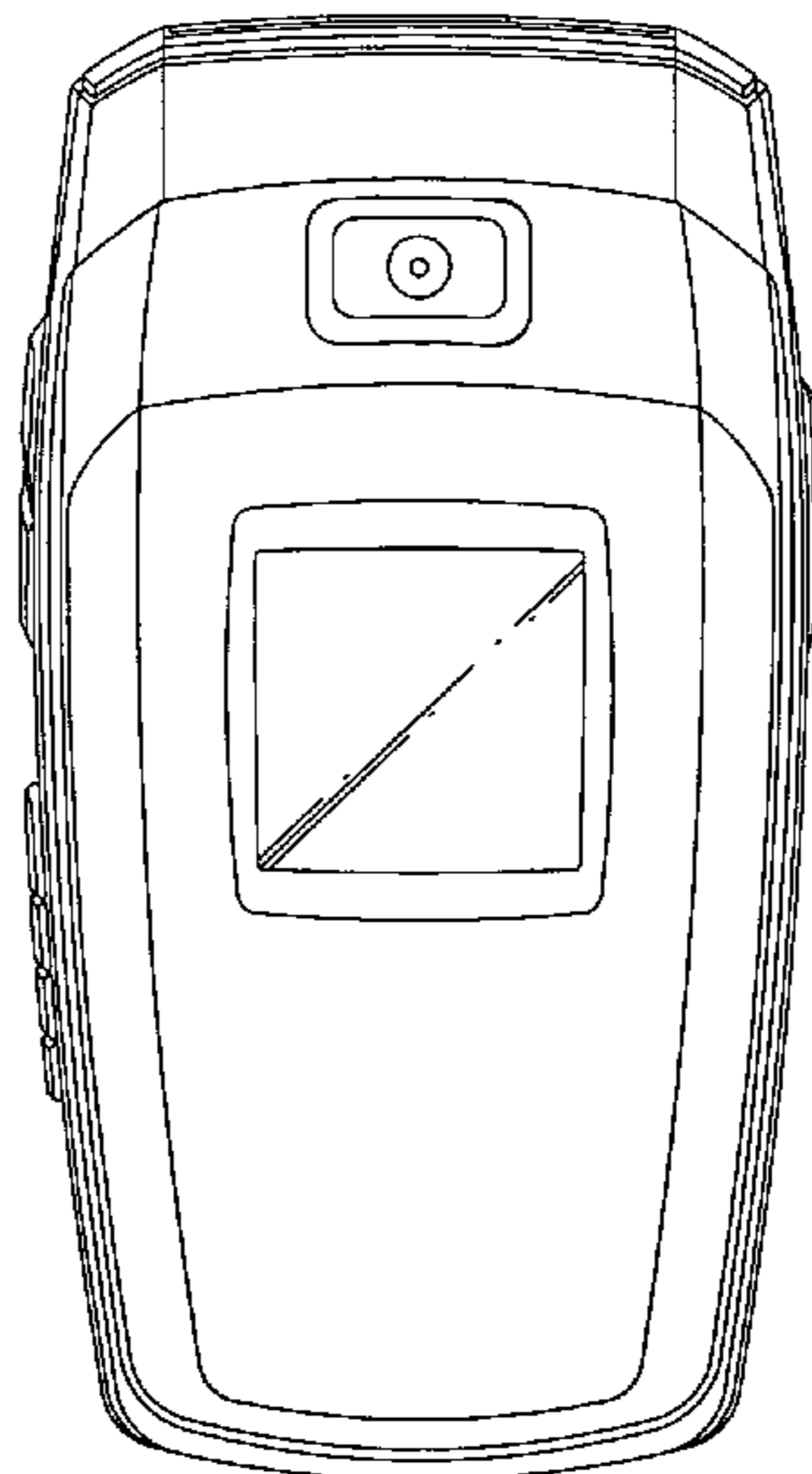

OTHER PUBLICATIONS

Samsung ZV60 telephone, announced Jul. 2007, [online], [site visited Jul. 19, 2008]. Available from Internet ,<URL: <http://www.gsmarena.com>>.*

Samsung X300 telephone, announced Feb. 2006, [online], [site visited Jul. 19, 2008]. Available from Internet ,<URL: <http://www.gsmarena.com>>.*

Samsung Z500 telephone, announced 1st quarter 2005, [online], [site visited Jul. 19, 2008]. Available from Internet ,<URL: <http://www.gsmarena.com>>.*

LG S5000 telephone, announced Oct. 2005, [online], [site visited Jul. 19, 2008]. Available from Internet ,<URL: <http://gsmarena.com>>.*

* cited by examiner

FIG. 1

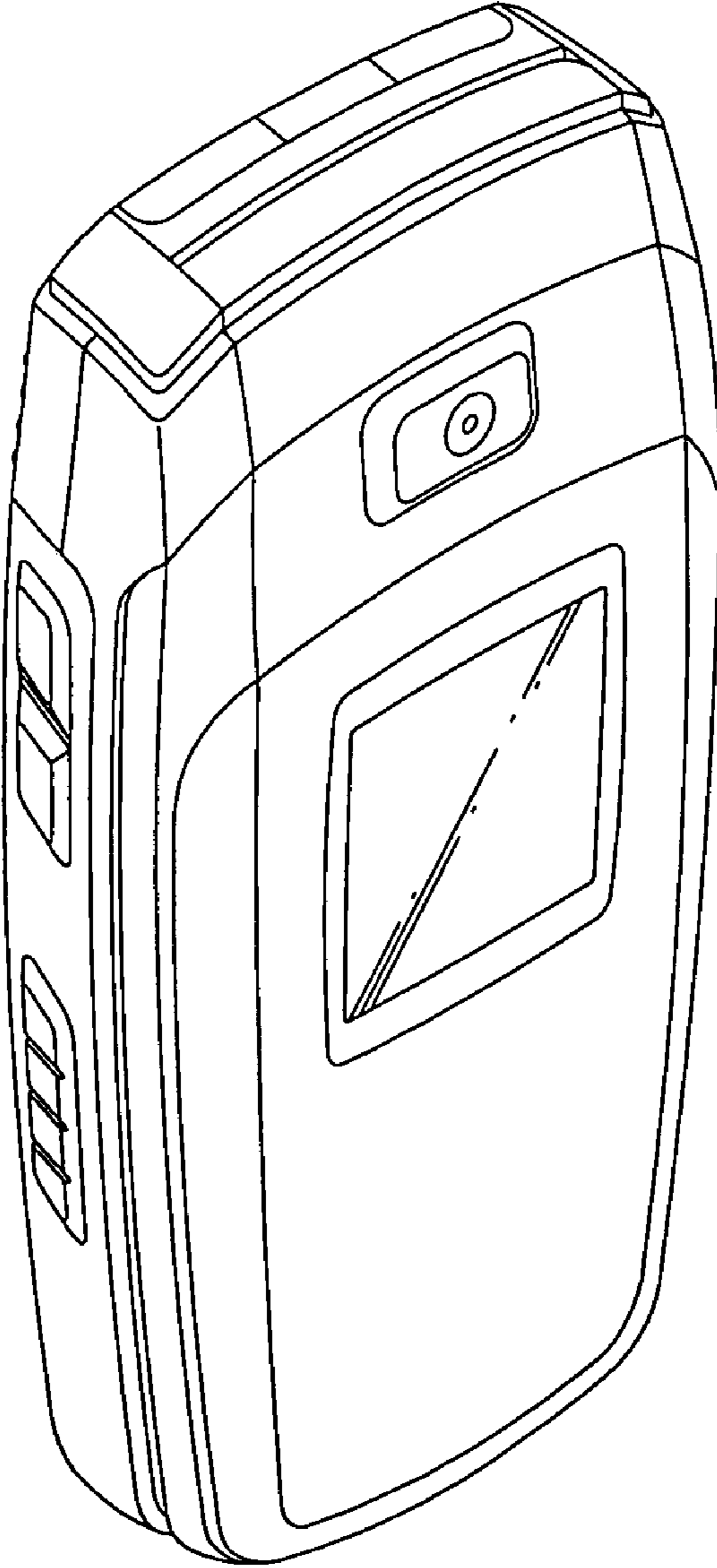

FIG. 2

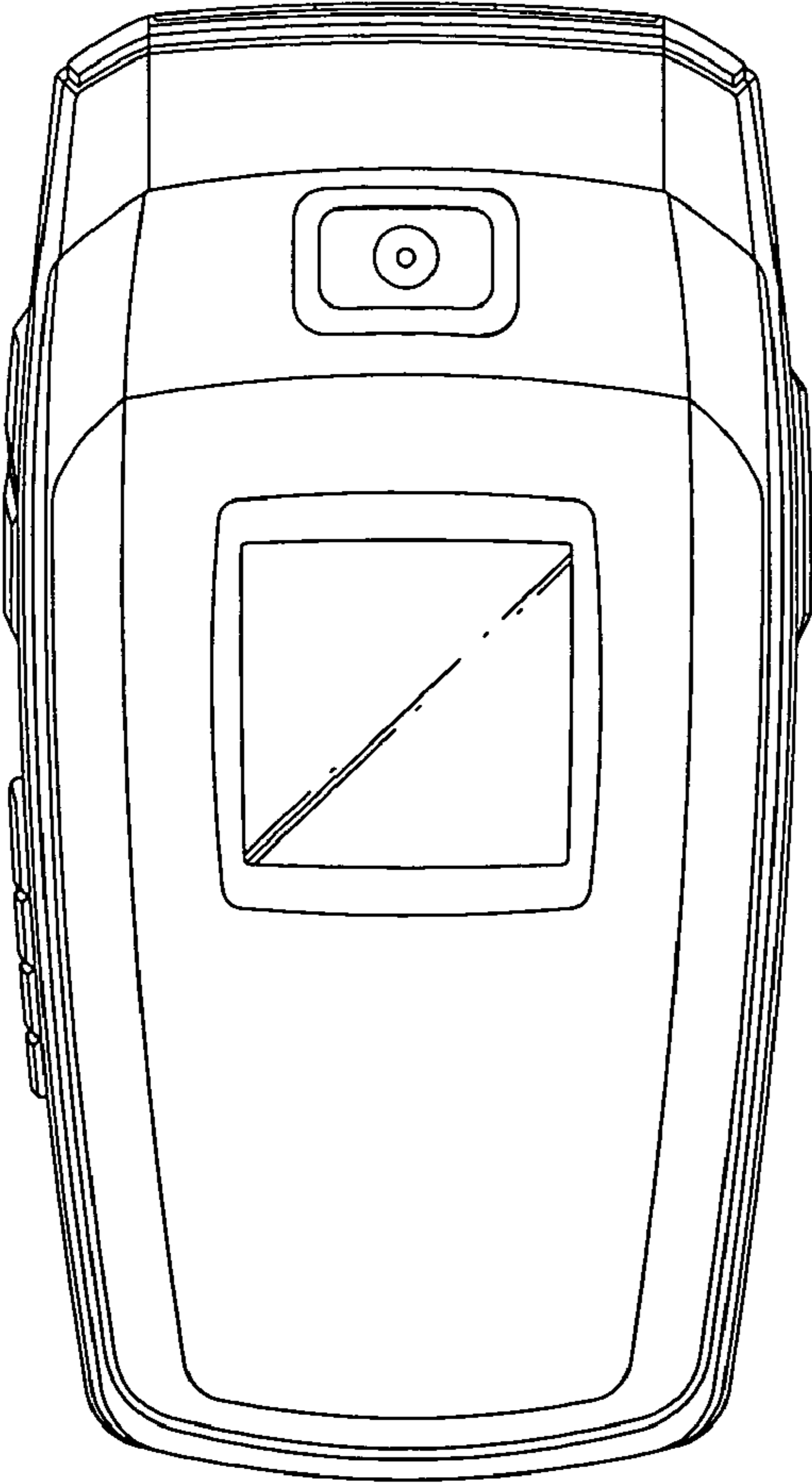

FIG. 3

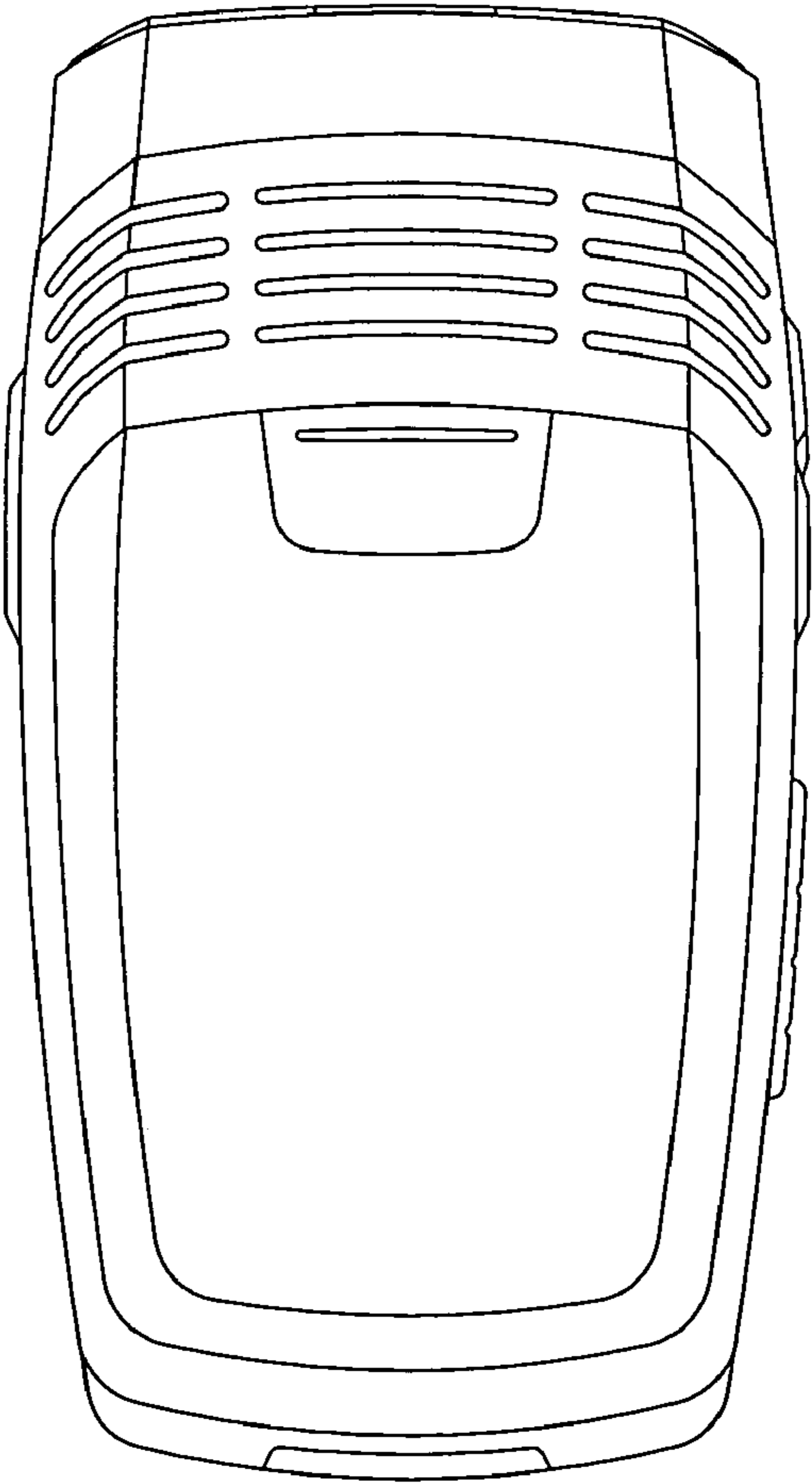

FIG. 4

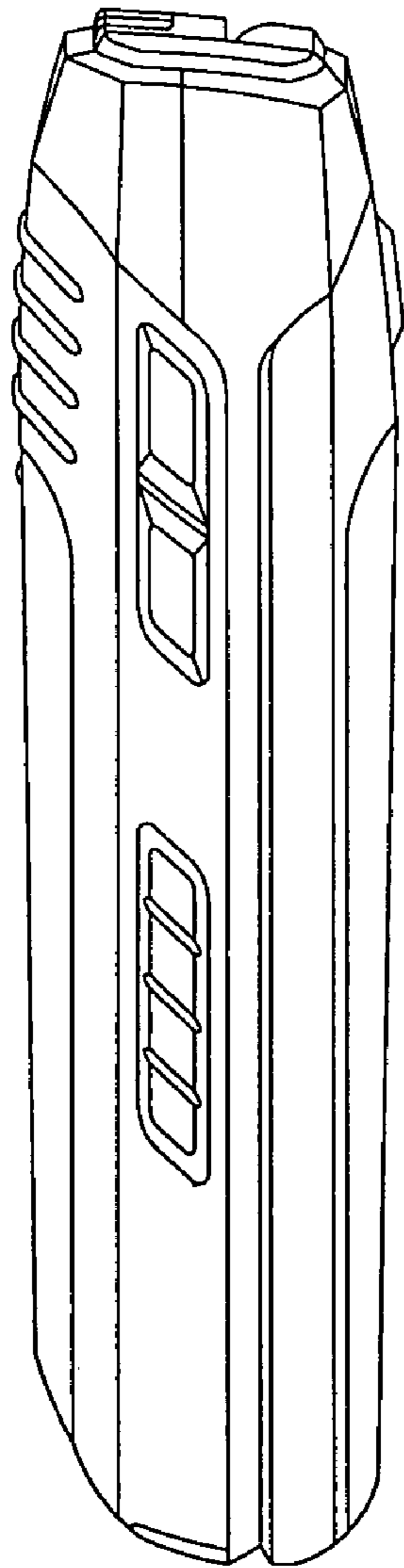

FIG. 5

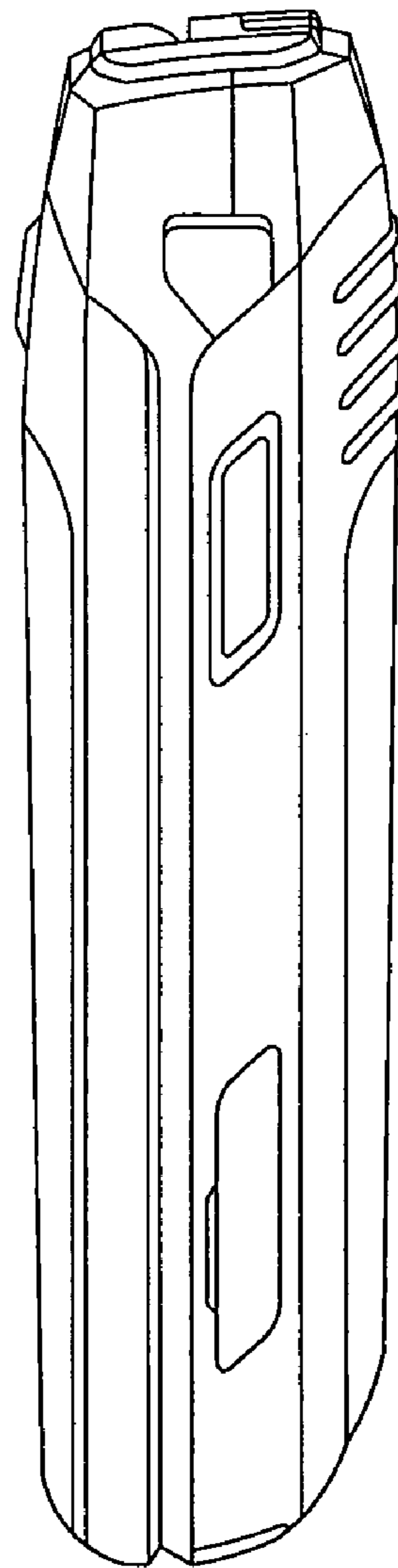

FIG. 6

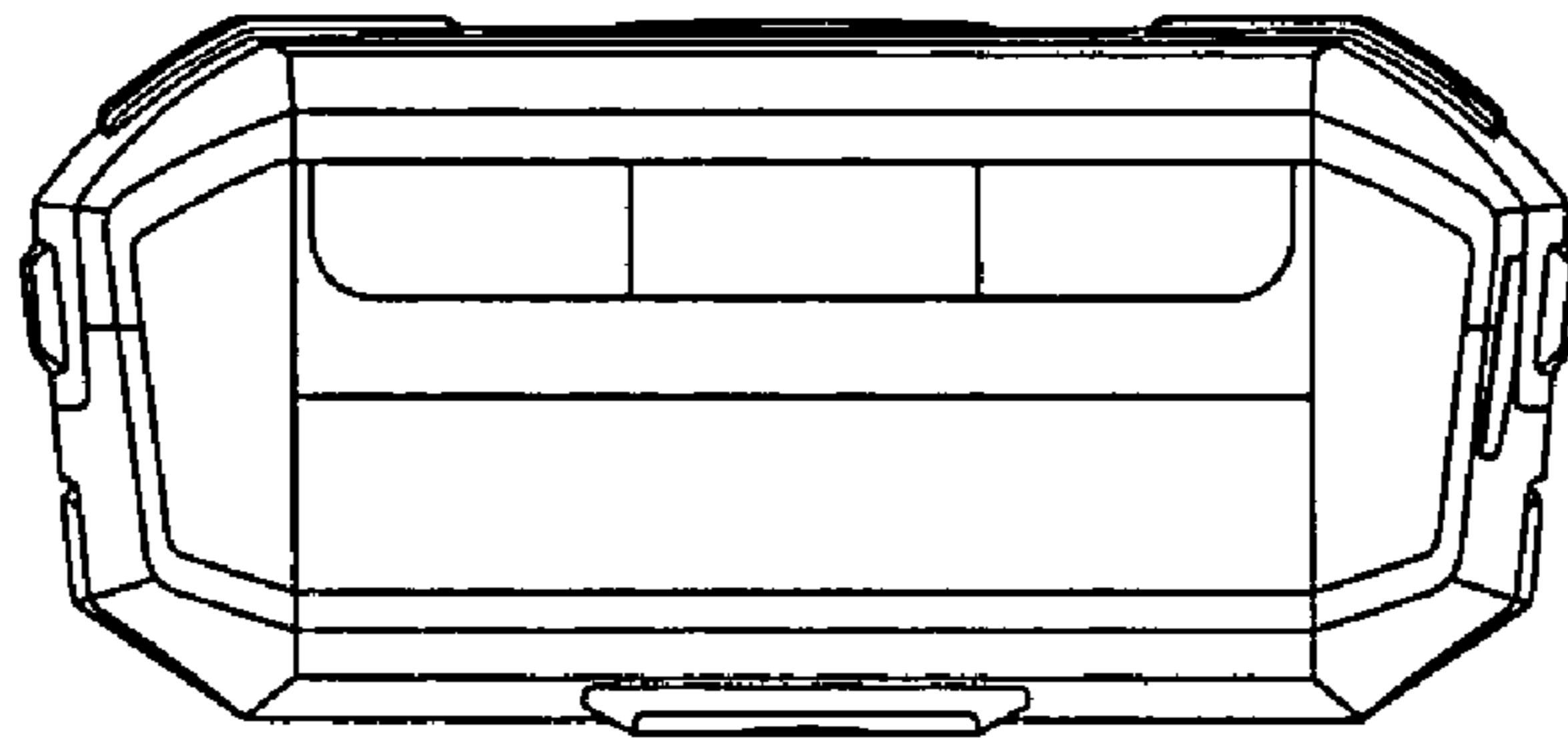

FIG. 7

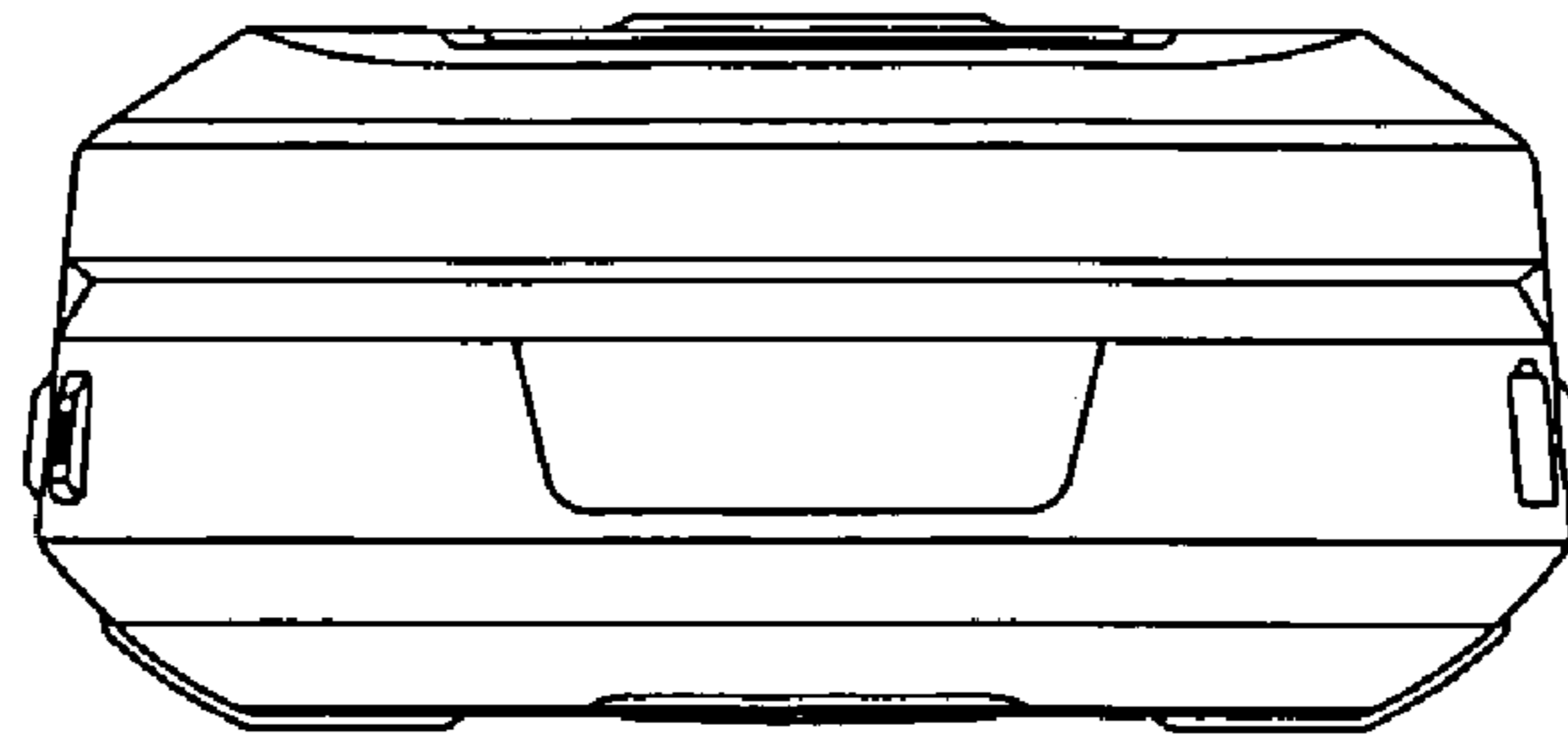

FIG. 8

