



US00D580226S

(12) **United States Design Patent**
Homma

(10) **Patent No.:** **US D580,226 S**

(45) **Date of Patent:** **** Nov. 11, 2008**

(54) **MUG**

D563,725 S * 3/2008 Alviar et al. D7/536

(75) Inventor: **Ken R. Homma**, Fountain Valley, CA
(US)

* cited by examiner

Primary Examiner—Philip Hyder
Assistant Examiner—Cynthia Underwood

(73) Assignee: **Logomark, Inc.**, Tustin, CA (US)

(74) *Attorney, Agent, or Firm*—Larry K. Roberts

(**) Term: **14 Years**

(57) **CLAIM**

(21) Appl. No.: **29/288,692**

The ornamental design for a mug, as shown and described.

(22) Filed: **Jun. 19, 2007**

DESCRIPTION

Related U.S. Application Data

(63) Continuation-in-part of application No. 29/273,472,
filed on Mar. 5, 2007.

FIG. 1 is an isometric view of an embodiment of the design;

FIG. 2 is a top view of the embodiment of FIG. 1;

FIG. 3 is a left side view of the embodiment of FIG. 1;

FIG. 4 is a front view of the embodiment of FIG. 1;

FIG. 5 is a right side view of the embodiment of FIG. 1;

FIG. 6 is a back view of the embodiment of FIG. 1;

FIG. 7 is a bottom view of the embodiment of FIG. 1;

FIG. 8 is an isometric view of another embodiment of the
design;

FIG. 9 is a top view of the embodiment of FIG. 8 ;

FIG. 10 is a left side view of the embodiment of FIG. 8;

FIG. 11 is a front view of the embodiment of FIG. 8;

FIG. 12 is a right side view of the embodiment of FIG. 8;

FIG. 13 is a back view of the embodiment of FIG. 8; and,

FIG. 14 is a bottom view of the embodiment of FIG. 8.

The features shown in broken lines are for illustrative pur-
poses only and form no part of the claimed design. The broken
lines in FIGS. 8 and 10–13 in the body of the mug which
define the bounds of the claimed design form no part thereof.

(51) **LOC (8) Cl.** **07-01**

(52) **U.S. Cl.** **D7/510; D7/533**

(58) **Field of Classification Search** D7/392.1,
D7/500, 509–511, 523, 538, 312, 316, 533,
D7/536, 532; D9/500, 537, 545; 62/457.3;
215/200, 387, DIG. 7; 220/711, 719, 298,
220/592.16, 592.17, 703; 229/404
See application file for complete search history.

(56) **References Cited**

U.S. PATENT DOCUMENTS

D38,167	S	*	8/1906	Wintermann	D9/500
1,197,389	A	*	9/1916	Newton	215/383
1,832,806	A	*	11/1931	Dawson	215/43
D226,962	S	*	5/1973	Krock	D7/536
D443,821	S	*	6/2001	Bakic	D9/500
D488,348	S	*	4/2004	Liu	D7/523
D502,633	S	*	3/2005	Liu	D7/523
D514,887	S	*	2/2006	Liu	D7/536
D556,515	S	*	12/2007	Trombly	D7/536
D562,076	S	*	2/2008	Sandberg	D7/533

1 Claim, 4 Drawing Sheets

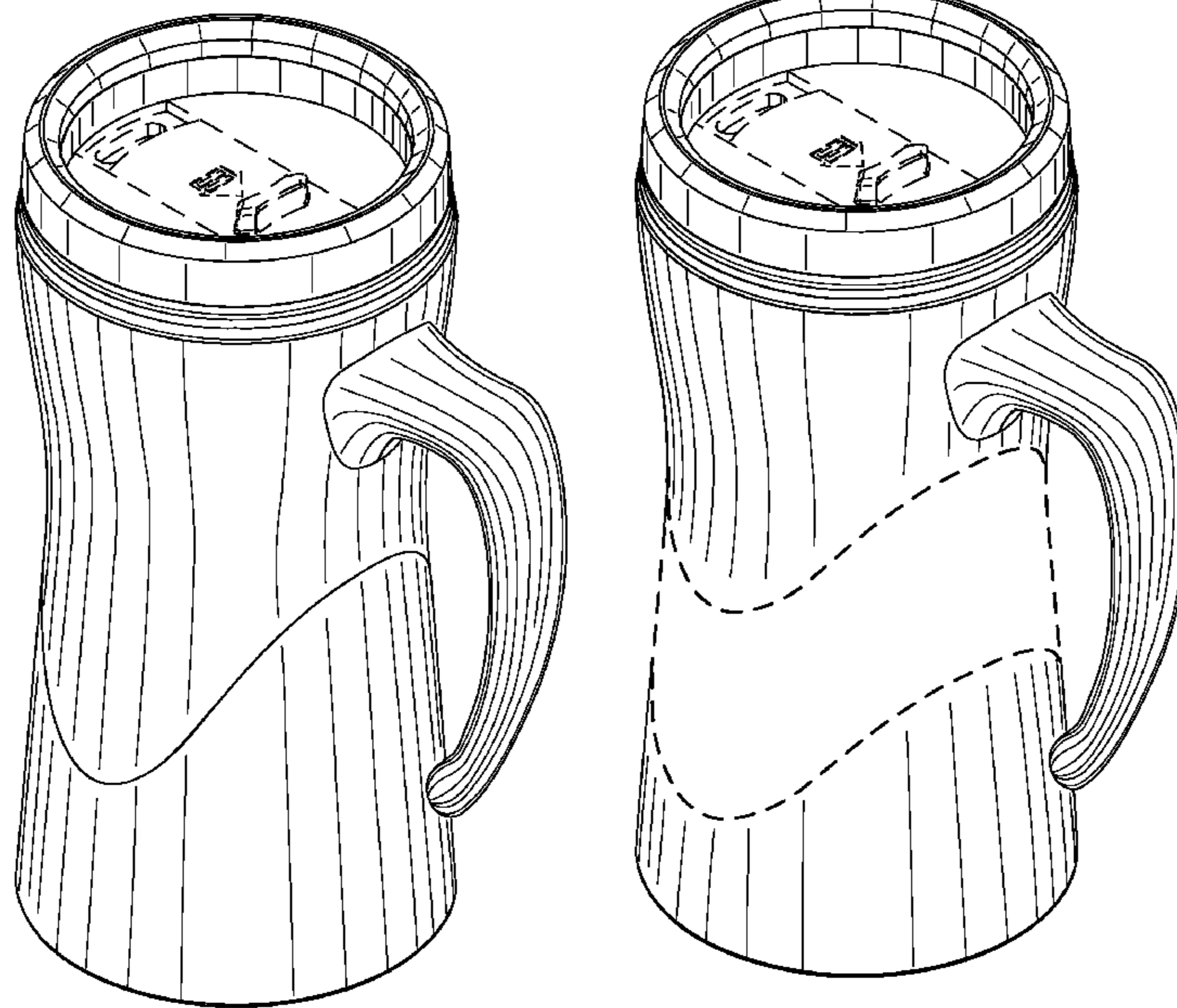

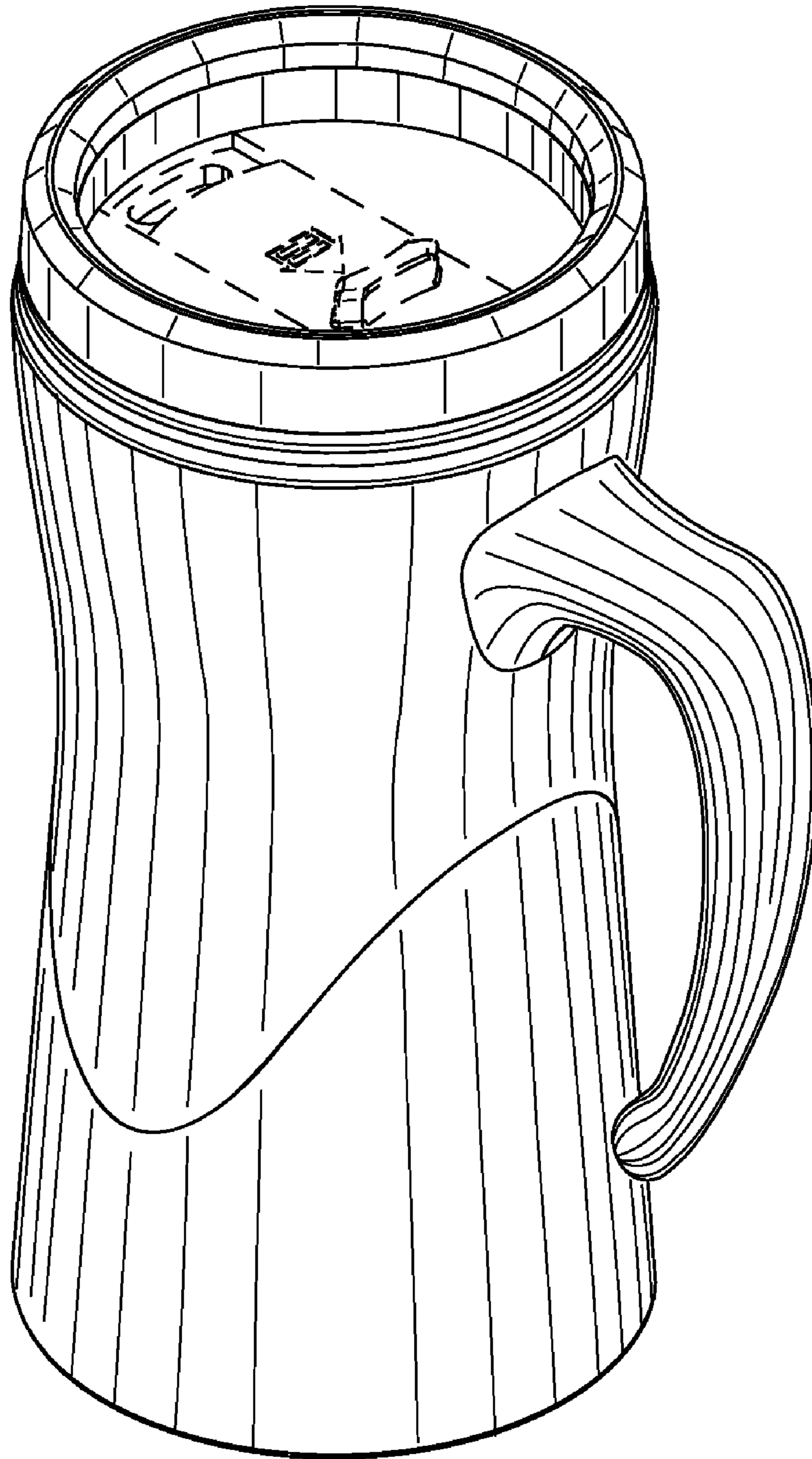

FIG. 1

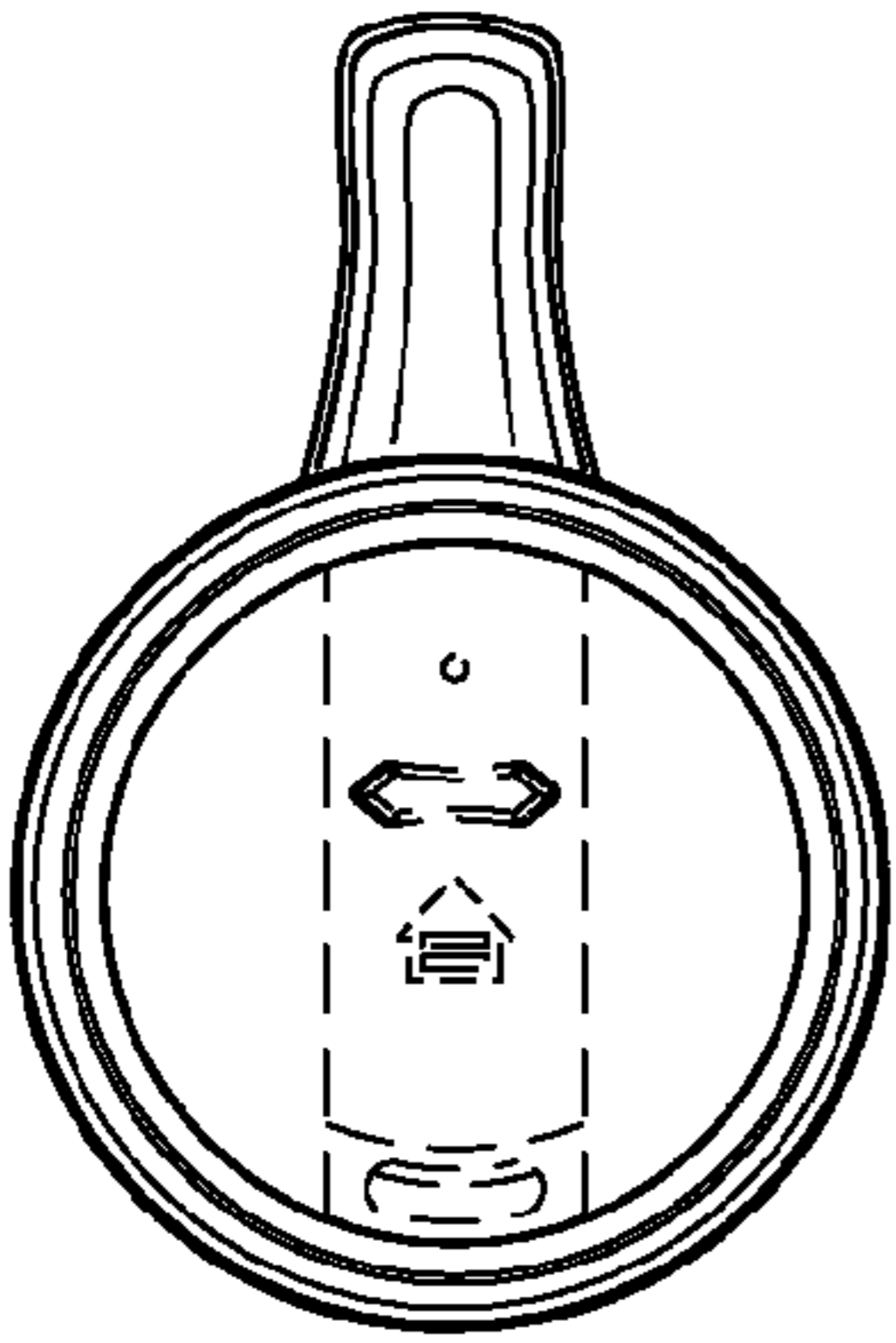

FIG. 2

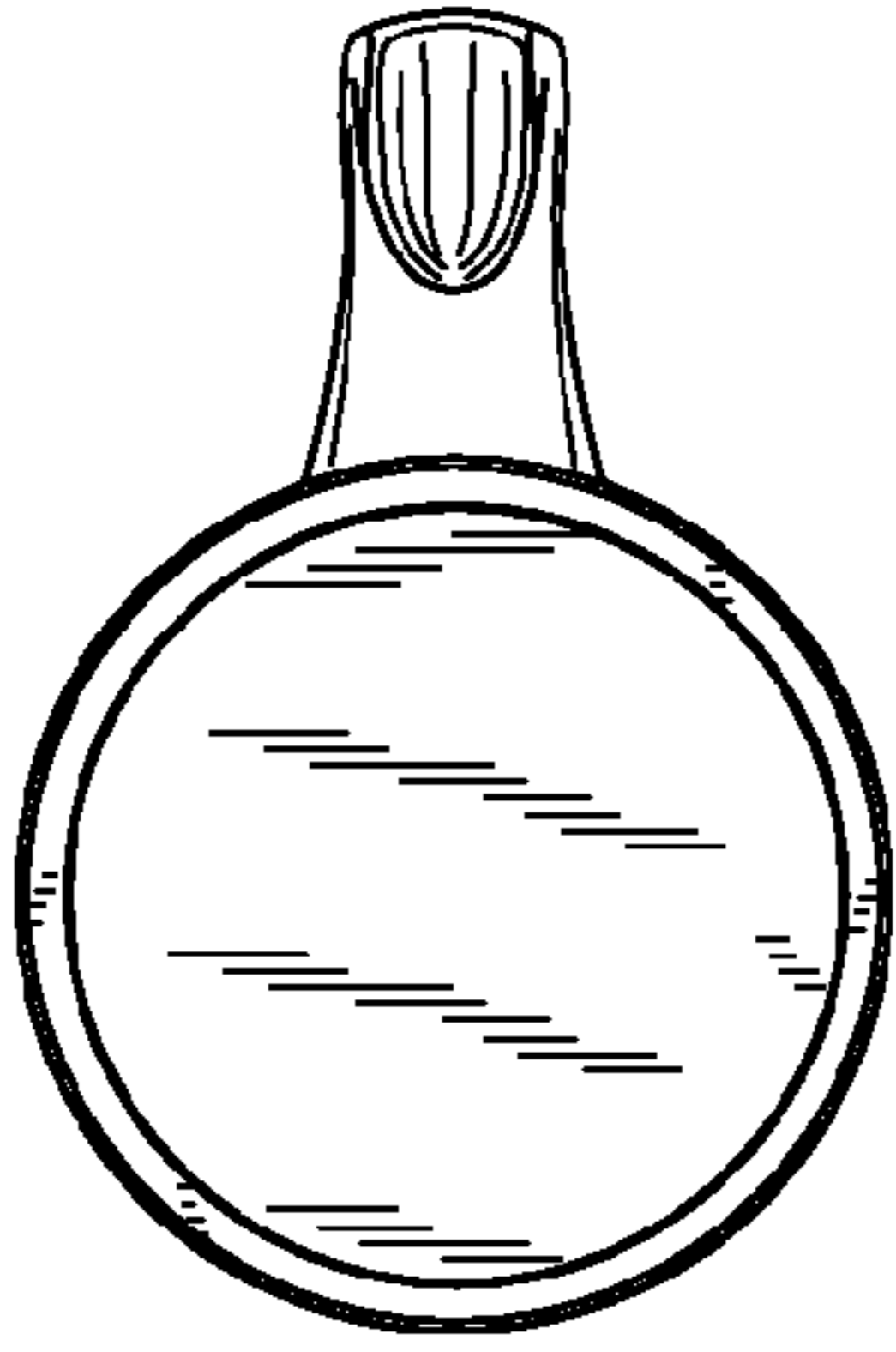

FIG. 7

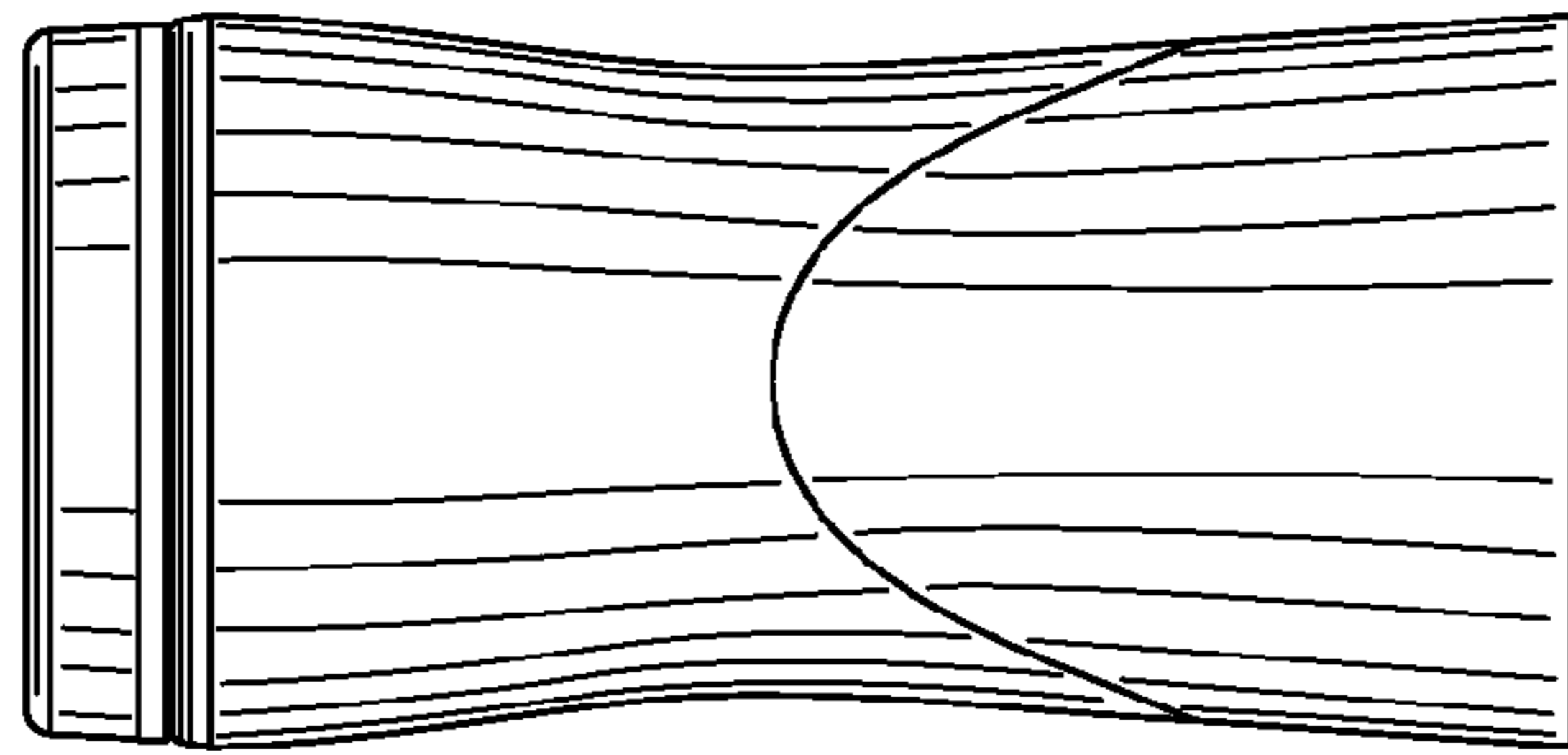

FIG. 3

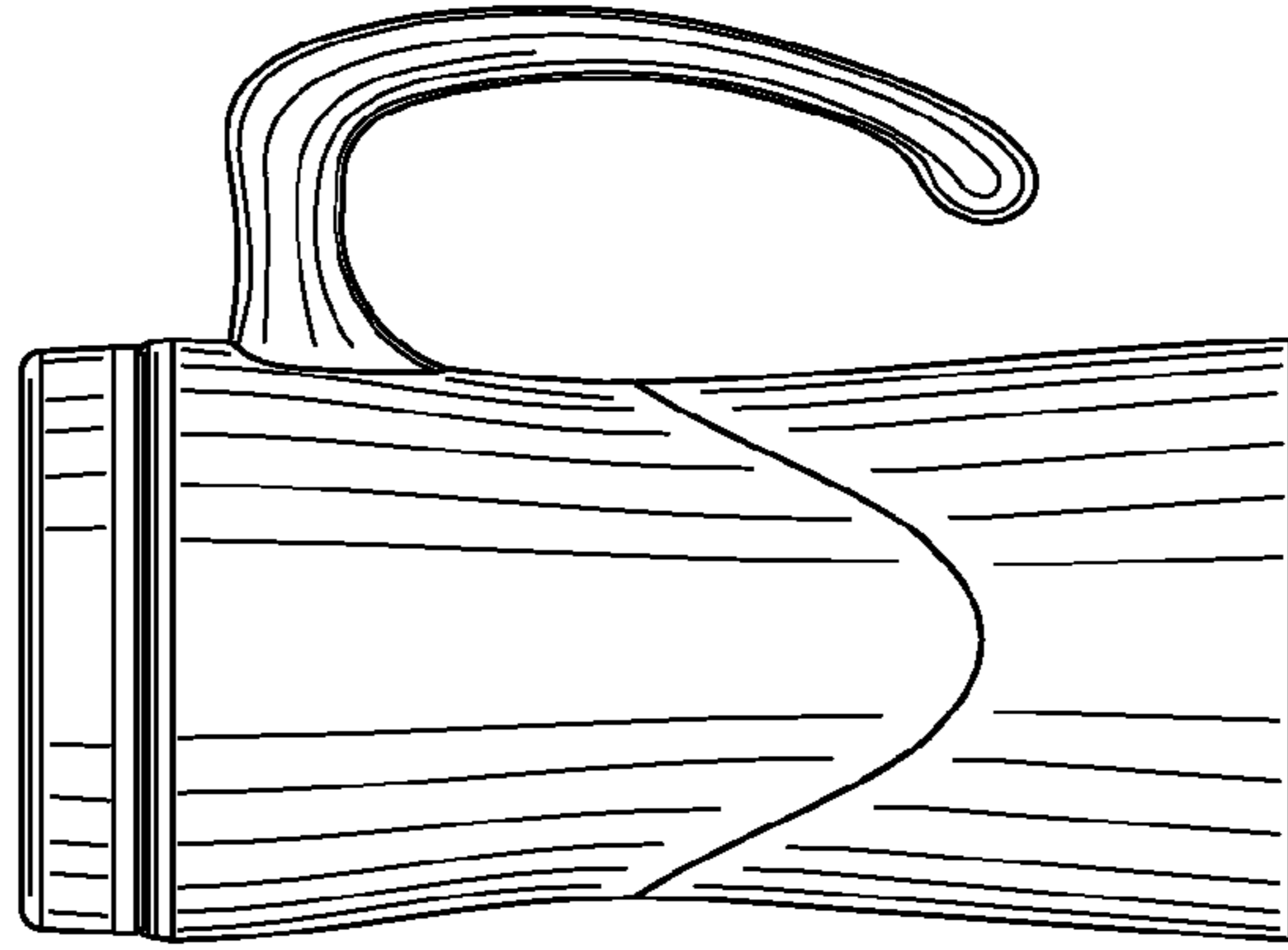

FIG. 4

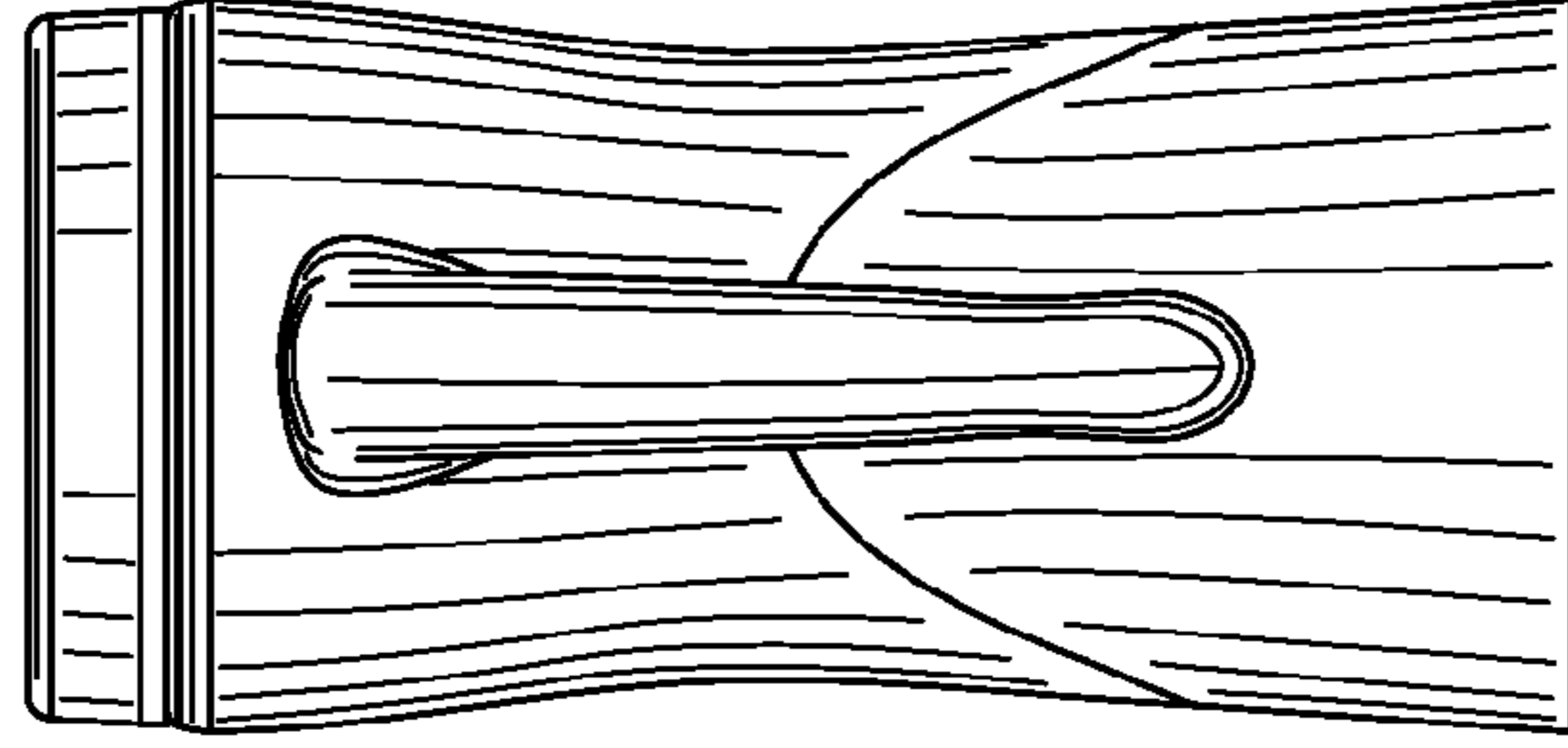

FIG. 5

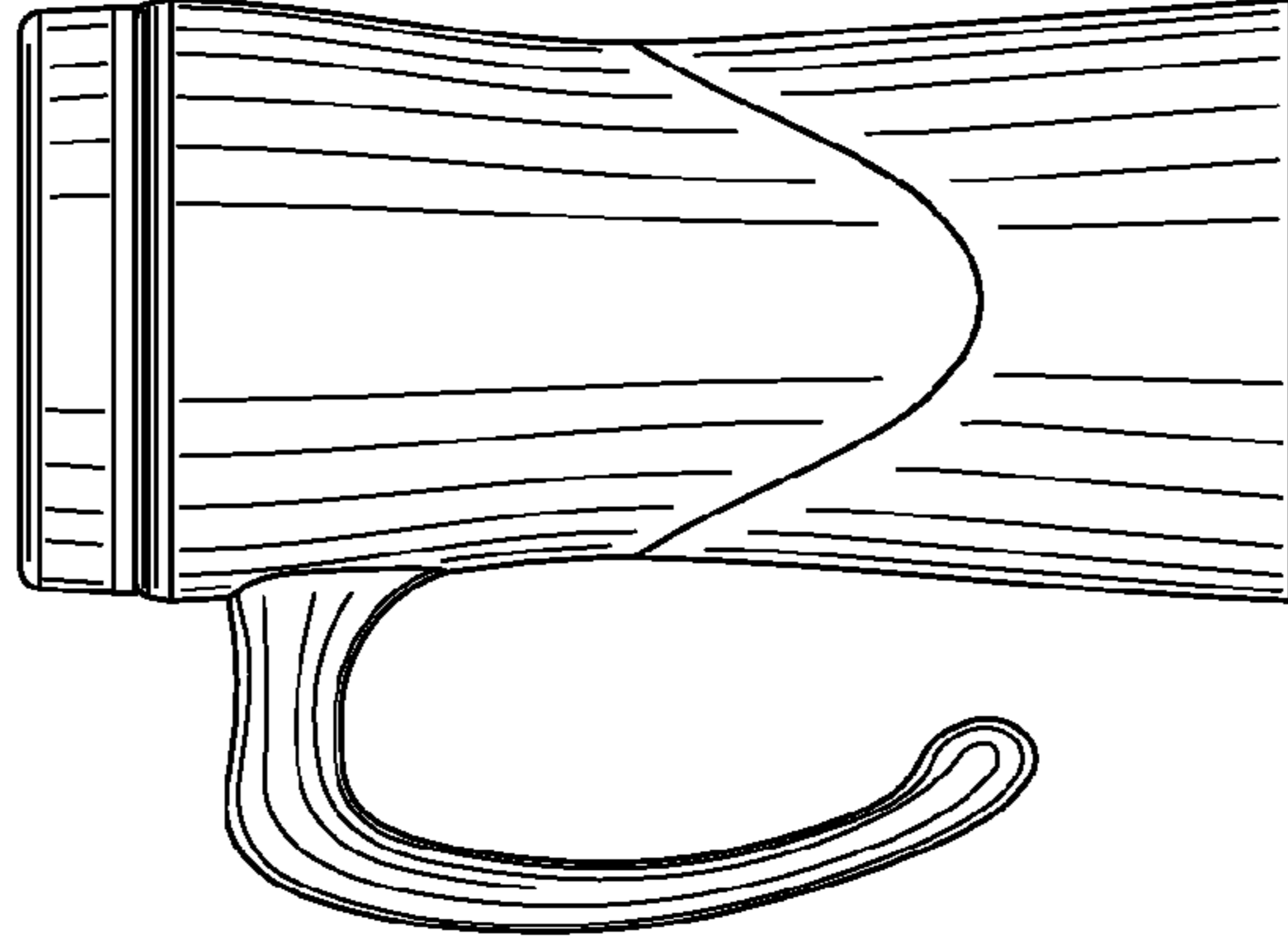

FIG. 6

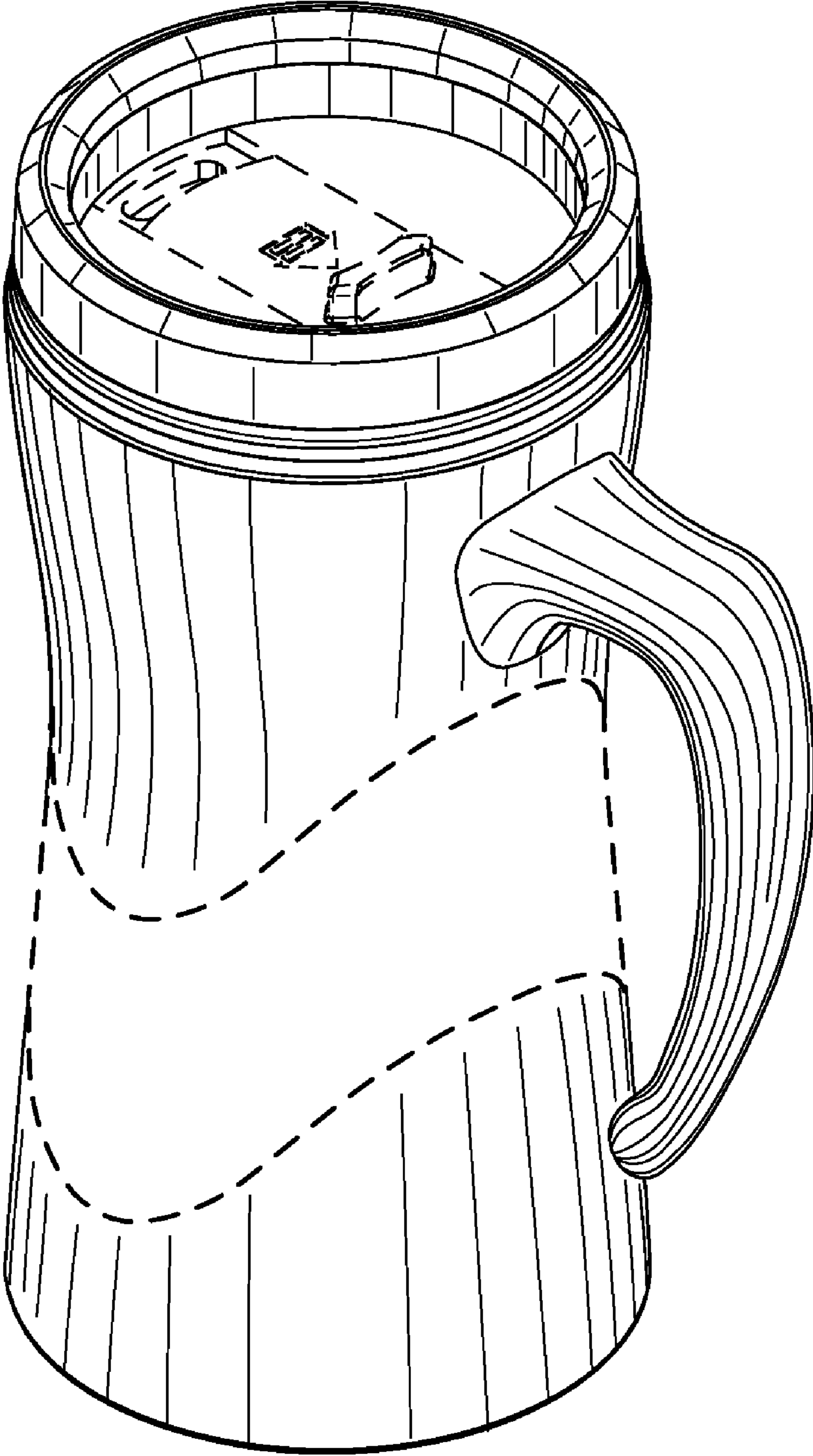

FIG. 8

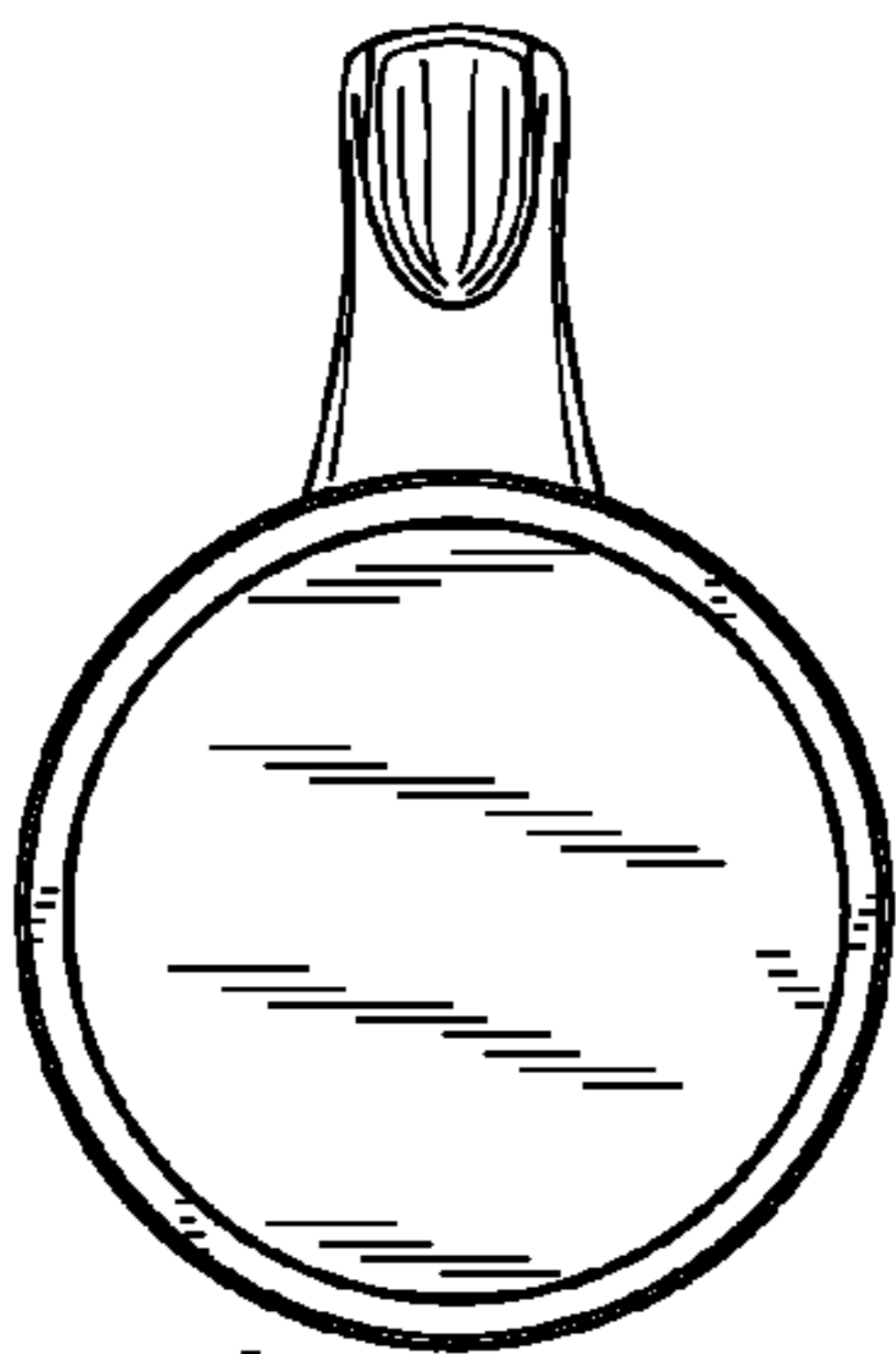

FIG. 14

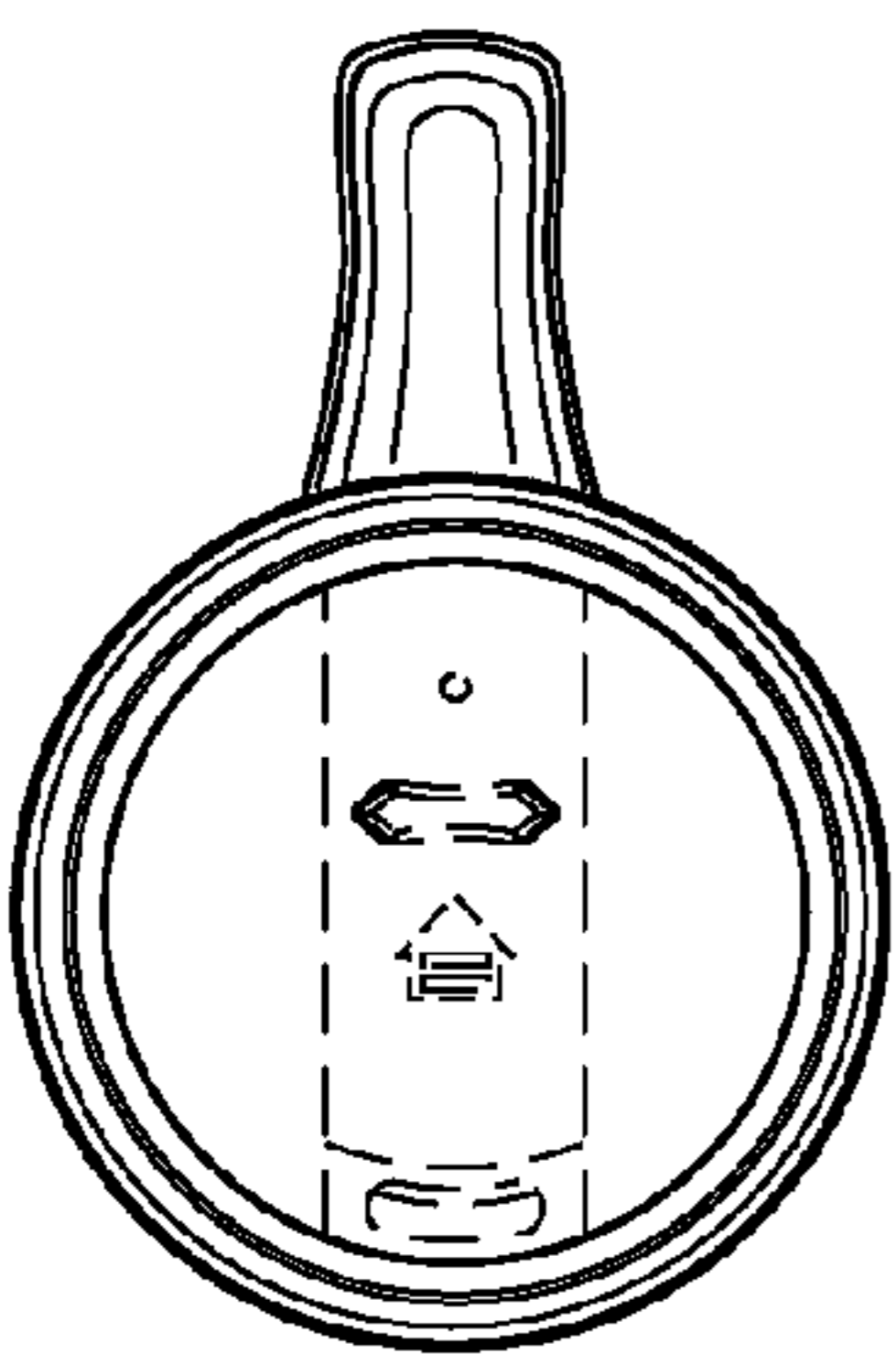

FIG. 9

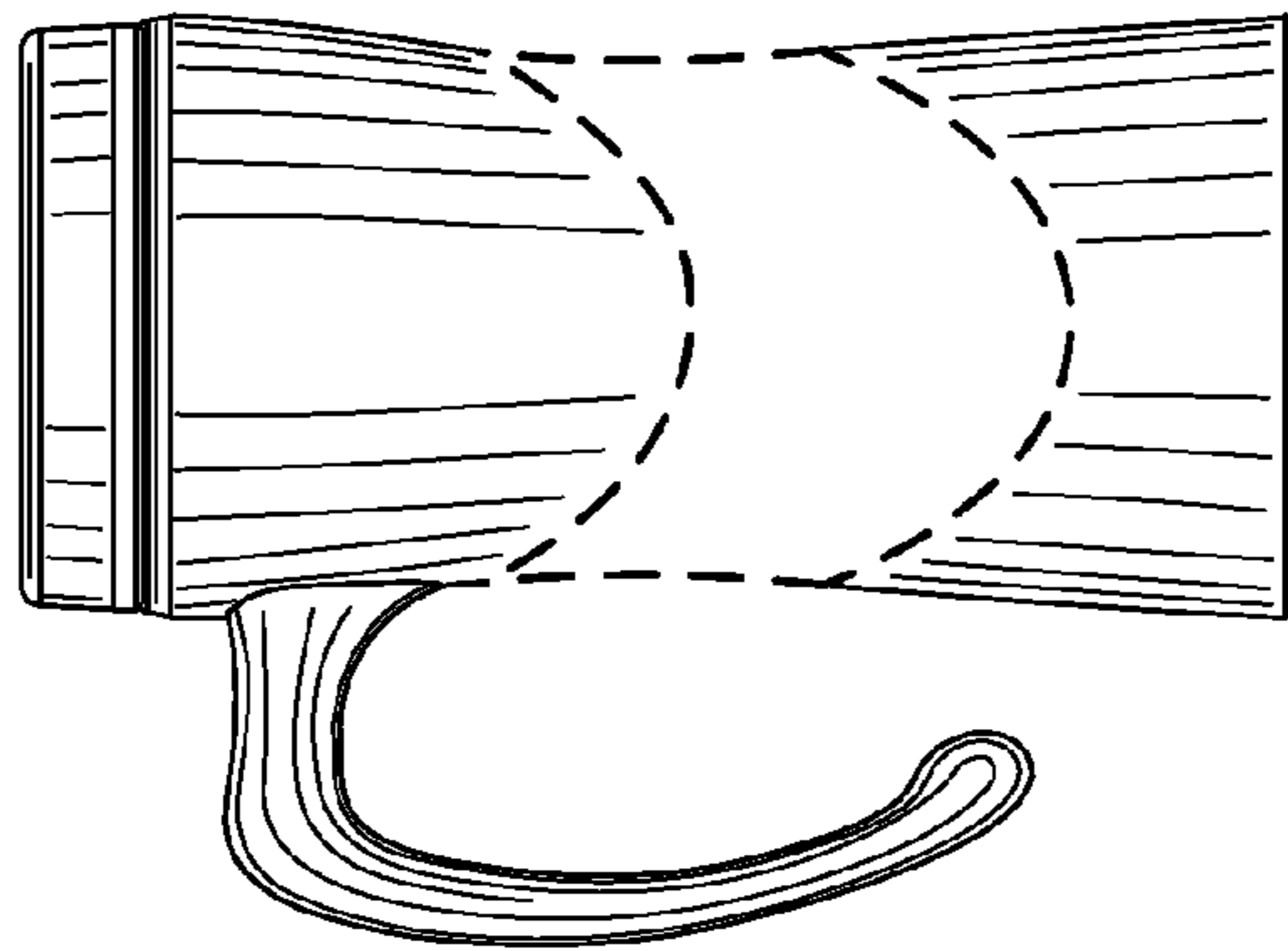

FIG. 13

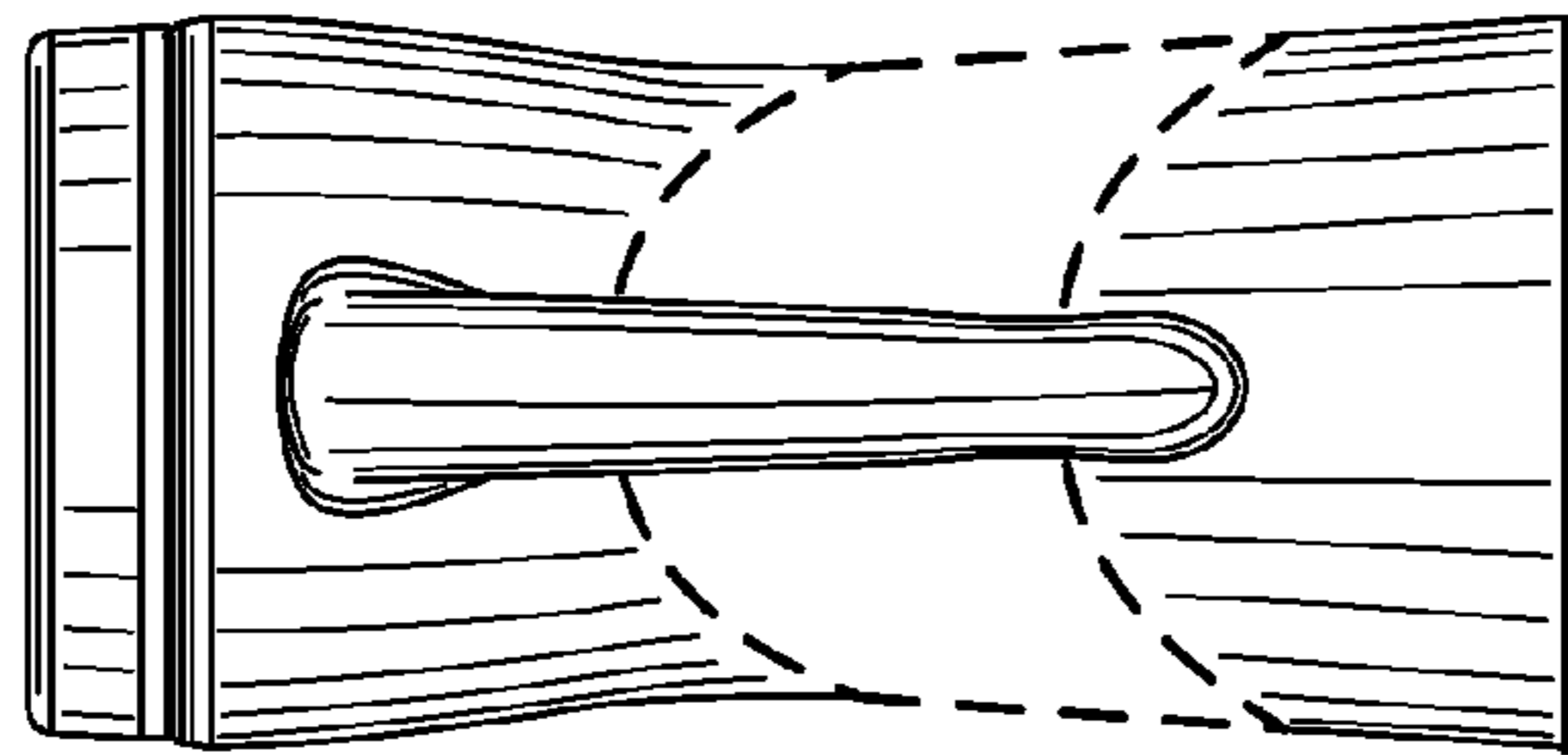

FIG. 12

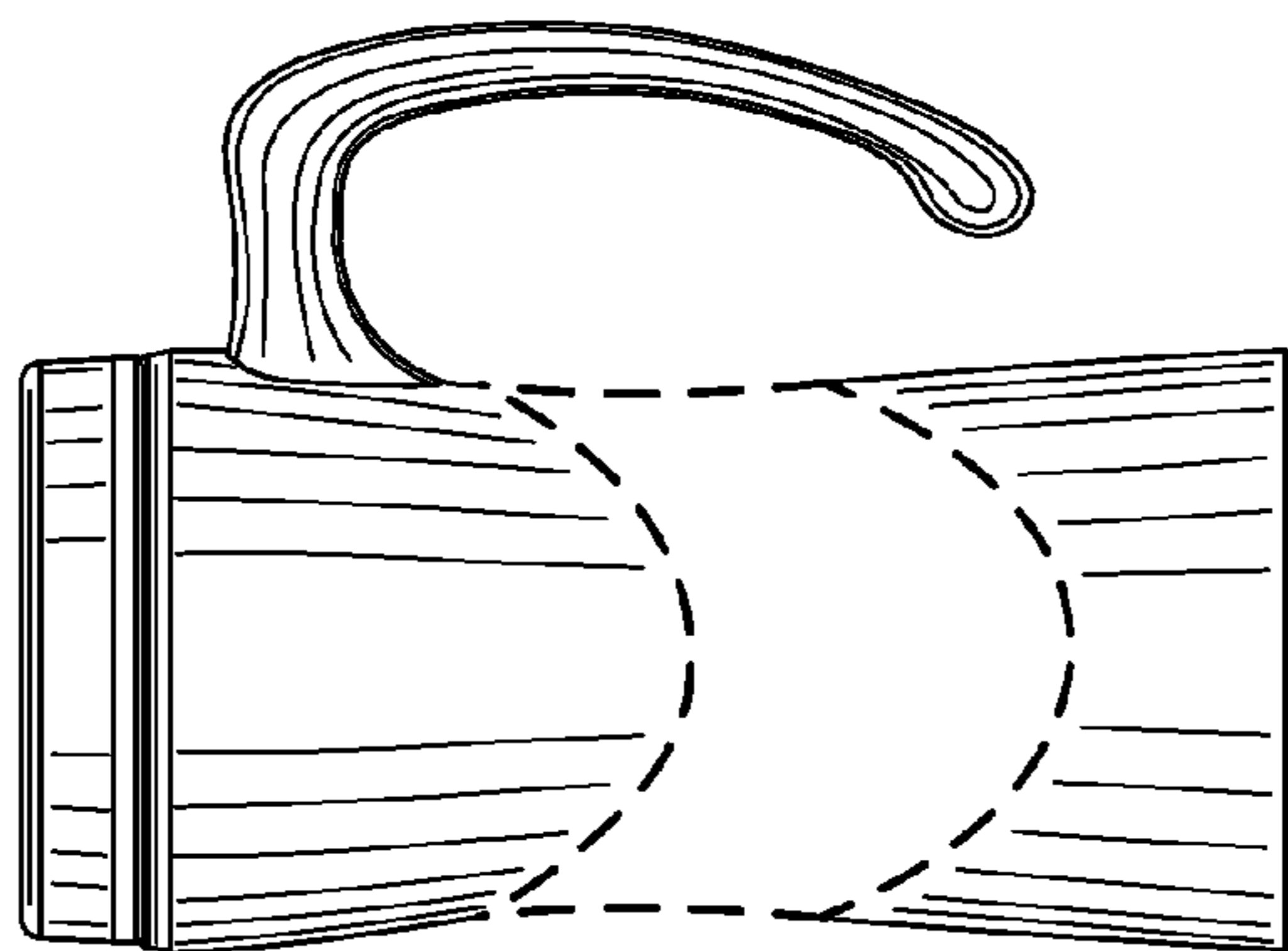

FIG. 11

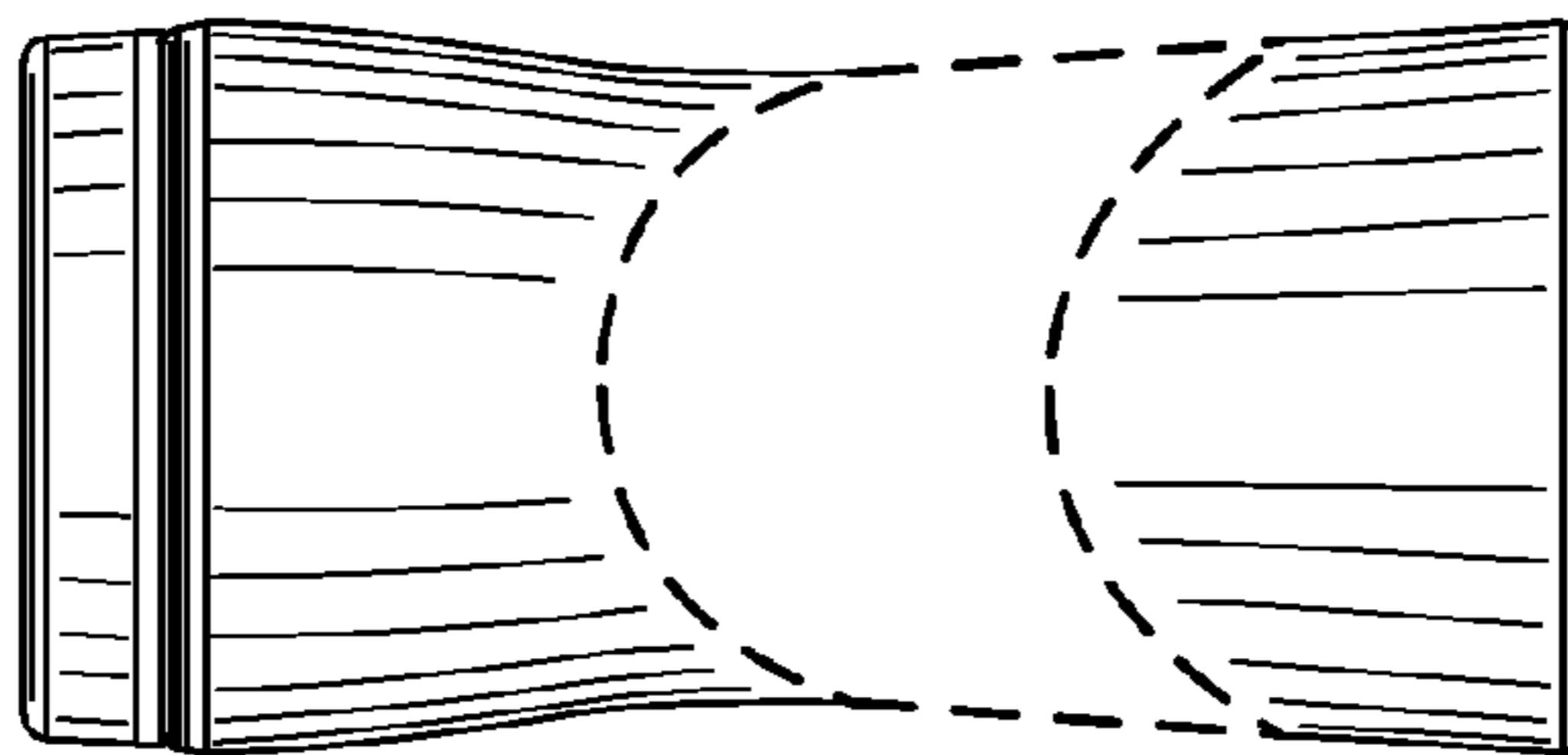

FIG. 10