



US00D580193S

(12) **United States Design Patent**
Sparkowski

(10) **Patent No.:** **US D580,193 S**

(45) **Date of Patent:** **** Nov. 11, 2008**

(54) **DISPLAY RACK**

(75) Inventor: **Robert P. Sparkowski**, Schaumburg, IL
(US)

(73) Assignee: **Chicago Display Marketing Corporation**, River Grove, IL (US)

(**) Term: **14 Years**

(21) Appl. No.: **29/267,932**

(22) Filed: **Oct. 25, 2006**

(51) **LOC (8) Cl.** **06-04**

(52) **U.S. Cl.** **D6/463**

(58) **Field of Classification Search** D6/449,
D6/455, 457, 470, 472, 475, 416, 417, 462,
D6/464-465, 474, 537, 562, 566, 567, 574,
D6/304-306, 468, 44, 436, 478, 467, 396,
D6/397, 479, 477, 466, 473, 463; 108/91-93,
108/107, 144.11, 149, 59, 161, 111, 2, 108;
248/156, 153, 235, 243; 312/107, 114, 117,
312/138.1, 204, 234; 52/165, 166; 211/59.4,
211/85.1, 135, 163, 69, 85.5, 85.2, 13.1,
211/153, 186-190, 194, 85.3, 86.01, 87.01,
211/90.01, 90.03, 134, 181.1; D3/10

See application file for complete search history.

(56) **References Cited**

U.S. PATENT DOCUMENTS

725,851 A	4/1903	Kopp
D89,907 S	5/1933	McGarry
1,971,744 A	8/1934	Brykczynski et al.
D114,228 S	4/1939	May
D130,415 S	11/1941	Pitner et al.
2,316,892 A	4/1943	Saul, Jr.

D154,111 S	6/1949	Falkenberg
D162,990 S *	4/1951	Roeder D6/463
2,579,704 A	12/1951	Saul, Jr.
2,648,442 A	8/1953	Lowmaster
D180,617 S *	7/1957	Patterson D6/464

(Continued)

Primary Examiner—Robert M Spear

Assistant Examiner—Katrina A Kile

(74) *Attorney, Agent, or Firm*—Michael Best & Friedrich LLP

(57) **CLAIM**

The ornamental design for a display rack, as shown and described.

DESCRIPTION

FIG. 1 is a perspective view;

FIG. 2 is a front view;

FIG. 3 is a side view, the opposite side view being a mirror image thereof;

FIG. 4 is a top view;

FIG. 5 is a rear view;

FIG. 6 is a bottom view;

FIG. 7 is a perspective view of the display rack of FIGS. 1-6, with the display panel in a lowered position; and,

FIG. 8 is a front view of the display rack of FIG. 7.

The broken lines shown in the two vertical support elements indicate that there is no particular height claimed. The downward sloping broken lines show the display rack support bars and form no part of the claimed design. -

1 Claim, 8 Drawing Sheets

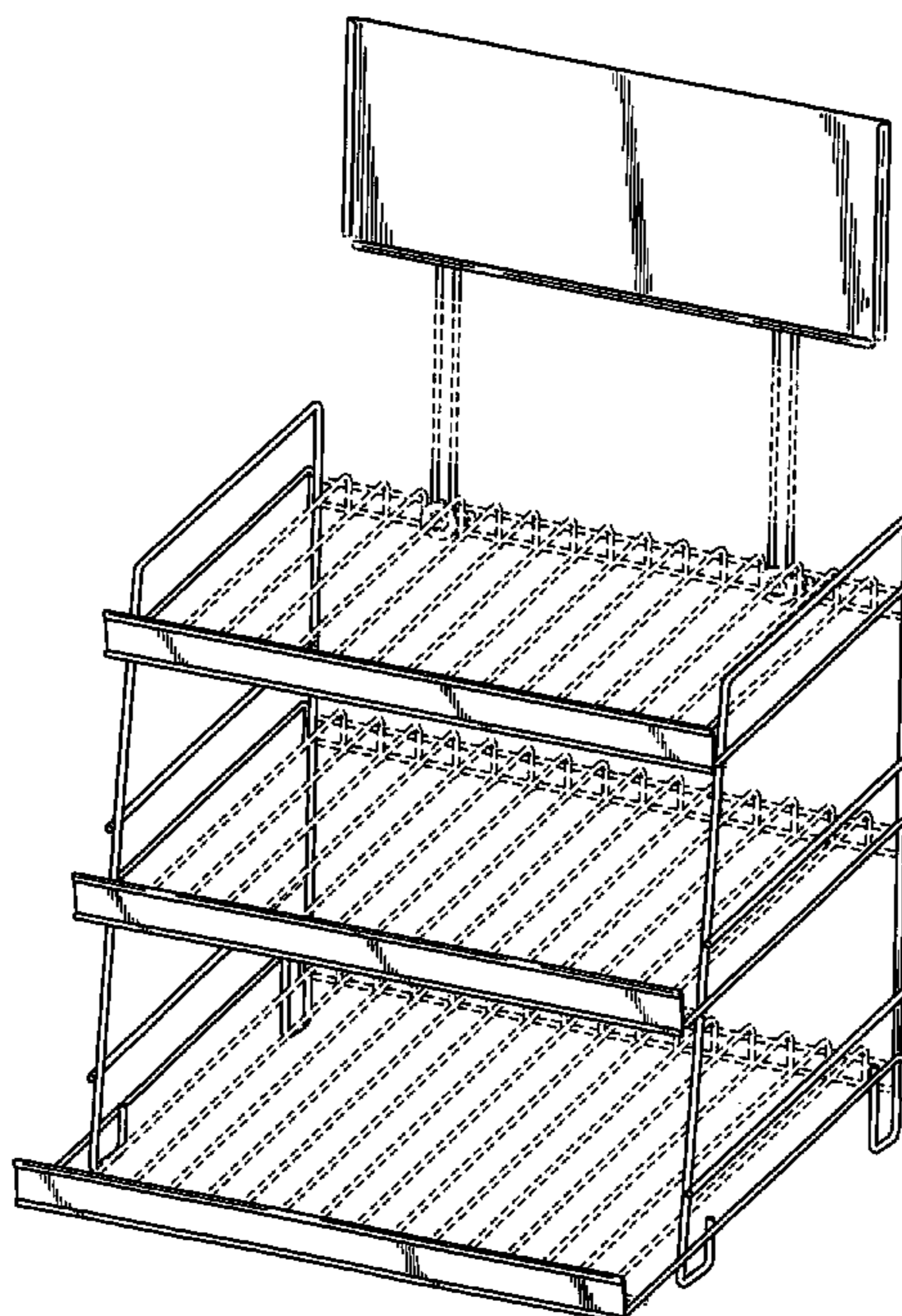

US D580,193 S

U.S. PATENT DOCUMENTS				
		5,240,127 A	8/1993	Levin et al.
D182,696 S *	4/1958 Strauss D3/315	5,273,248 A	12/1993	Grandner
D184,190 S	12/1958 McCowan	5,326,062 A	7/1994	Remmers
2,918,295 A *	12/1959 Milner 280/652	5,351,842 A	10/1994	Remmers
2,958,424 A *	11/1960 Bigatti 211/41.5	5,383,562 A	1/1995	Gay
2,959,298 A	11/1960 Pope	5,397,087 A	3/1995	Teece
D190,107 S	4/1961 Glaser	5,450,971 A	9/1995	Boron et al.
3,081,718 A	3/1963 Shoffner	5,480,039 A	1/1996	Merl
3,186,527 A	6/1965 Konstant et al.	5,482,168 A	1/1996	Welch et al.
3,199,683 A	8/1965 Graswich	D369,036 S	4/1996	Wyatt et al.
3,294,351 A	12/1966 Rollins, Jr.	D369,037 S	4/1996	Wyatt et al.
3,311,072 A	3/1967 Pattison	D373,913 S	9/1996	Wyatt et al.
3,403,789 A	10/1968 Morte et al.	5,601,038 A	2/1997	Welch et al.
3,527,339 A	9/1970 Ambertson	5,628,257 A	5/1997	Conner et al.
D220,345 S *	3/1971 Burke D6/463	5,641,083 A	6/1997	Metcalf
3,575,484 A	4/1971 Kesling	5,645,182 A	7/1997	Miller, Jr. et al.
3,640,389 A	2/1972 Snyder	5,704,497 A	1/1998	Wyatt
3,730,467 A	5/1973 Dutchburn	5,718,441 A	2/1998	Kern et al.
D233,380 S	10/1974 Hyman	5,797,502 A	8/1998	Brady et al.
3,891,228 A	6/1975 Rhinehart et al.	5,806,820 A	9/1998	Simon
3,915,097 A	10/1975 Young, Jr.	5,868,263 A	2/1999	McAllister et al.
3,953,044 A	4/1976 Wilson	5,899,041 A	5/1999	Durin
3,993,002 A	11/1976 Stroh	5,915,097 A	6/1999	Young, Jr.
4,004,819 A	1/1977 Brongo	6,095,347 A	8/2000	Mauro-Vetter
D243,891 S	4/1977 Snyder	D430,432 S	9/2000	Mason
4,045,043 A	8/1977 Fourrey	6,116,436 A	9/2000	Ferrucci et al.
D246,773 S	12/1977 Bladis	D431,937 S	10/2000	Heiny et al.
4,086,858 A	5/1978 Howitt	D432,332 S	10/2000	Kashima
4,093,077 A	6/1978 Strasser	D435,743 S	1/2001	Glauth et al.
4,109,797 A	8/1978 Brunette	D436,756 S	1/2001	Kashima
D249,615 S *	9/1978 Frisbey D6/463	6,203,029 B1	3/2001	Ondrasik
4,122,955 A	10/1978 Celms	6,299,001 B1	10/2001	Frolov et al.
D252,967 S	9/1979 Denhoff	D451,024 S	11/2001	Glauth et al.
4,231,301 A	11/1980 Barrineau, III	D451,704 S	12/2001	Curci
D259,161 S	5/1981 Thauer	6,332,547 B1	12/2001	Shaw et al.
4,292,902 A	10/1981 Barrineau	6,364,137 B1	4/2002	Glauth et al.
4,297,952 A	11/1981 Zagaroli	6,386,096 B1	5/2002	Tiemann
4,302,025 A	11/1981 Waddell et al.	6,419,098 B1	7/2002	Hall
4,397,606 A	8/1983 Bruton	D478,739 S	8/2003	Sparkowski
4,428,304 A	1/1984 Moser	D478,745 S	8/2003	Sparkowski
4,444,323 A	4/1984 Travis	6,605,777 B1	8/2003	Anderson et al.
4,492,169 A	1/1985 Ware et al.	6,607,083 B1	8/2003	Webb
D282,127 S	1/1986 Weiller	6,669,213 B2	12/2003	Woerner
4,588,096 A	5/1986 Story et al.	D486,982 S	2/2004	Hessell
4,606,280 A	8/1986 Poulton et al.	6,726,035 B2	4/2004	Zadak
D285,991 S	10/1986 Madsen	6,729,484 B2	5/2004	Sparkowski
4,624,376 A	11/1986 Bertram	6,749,208 B2	6/2004	Orozco et al.
4,627,542 A	12/1986 Fredrickson	6,773,081 B2	8/2004	Yuyama et al.
D288,038 S	2/1987 Henning	D497,738 S	11/2004	Sparkowski
D288,640 S	3/1987 Campbell	6,811,163 B1	11/2004	Guruleet et al.
D289,353 S	4/1987 Davis et al.	6,811,164 B2	11/2004	Trogstam
4,776,472 A	10/1988 Rosen	D500,419 S	1/2005	Sparkowski
D306,805 S	3/1990 Larson et al.	6,874,430 B1	4/2005	McCandless
D306,942 S *	4/1990 Patke D6/463	6,880,708 B2	4/2005	Boron
4,932,333 A	6/1990 Jensen et al.	6,883,881 B2	4/2005	Gauss
4,951,827 A	8/1990 Moransais	6,918,498 B2	7/2005	Sparkowski
4,986,555 A	1/1991 Andreen	6,935,523 B2	8/2005	Ahn
D315,459 S	3/1991 Young et al.	D515,336 S	2/2006	Sparkowski
4,996,929 A	3/1991 Saal	D520,265 S	5/2006	Sparkowski
4,999,862 A	3/1991 Hefty	D524,573 S *	7/2006	Robinson et al. D6/463
D317,094 S *	5/1991 Weinberg et al. D6/463	D526,818 S	8/2006	Sparkowski
D318,585 S	7/1991 Duff et al.	D534,375 S	1/2007	Sparkowski
5,029,895 A	7/1991 Anderson	D534,376 S	1/2007	Sparkowski
5,062,605 A	11/1991 Muhlethaler	D547,093 S *	7/2007	Butters D6/462
5,072,839 A	12/1991 Arnone	D573,369 S *	7/2008	Sparkowski D6/463
D325,480 S	4/1992 Krautsack	2002/0130098 A1	9/2002	Simard
D326,970 S	6/1992 Allen	2004/0007549 A1	1/2004	Klein et al.
5,160,051 A	11/1992 Bustos	2004/0011752 A1	1/2004	Zadak
D331,336 S *	12/1992 Keong D6/464	2004/0089625 A1	5/2004	Tsai
D334,859 S	4/1993 Homann			

* cited by examiner

FIG. 1

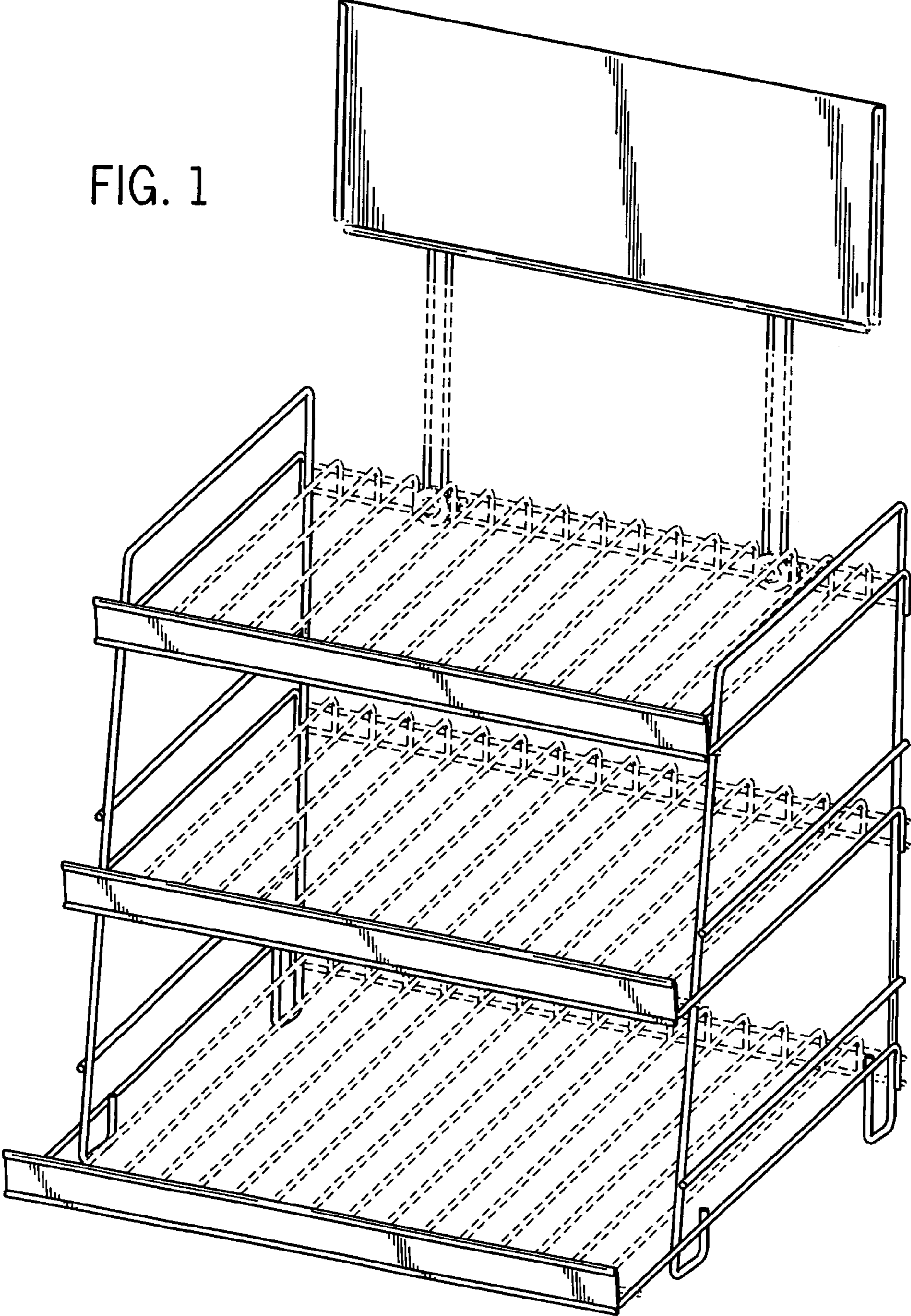

FIG. 2

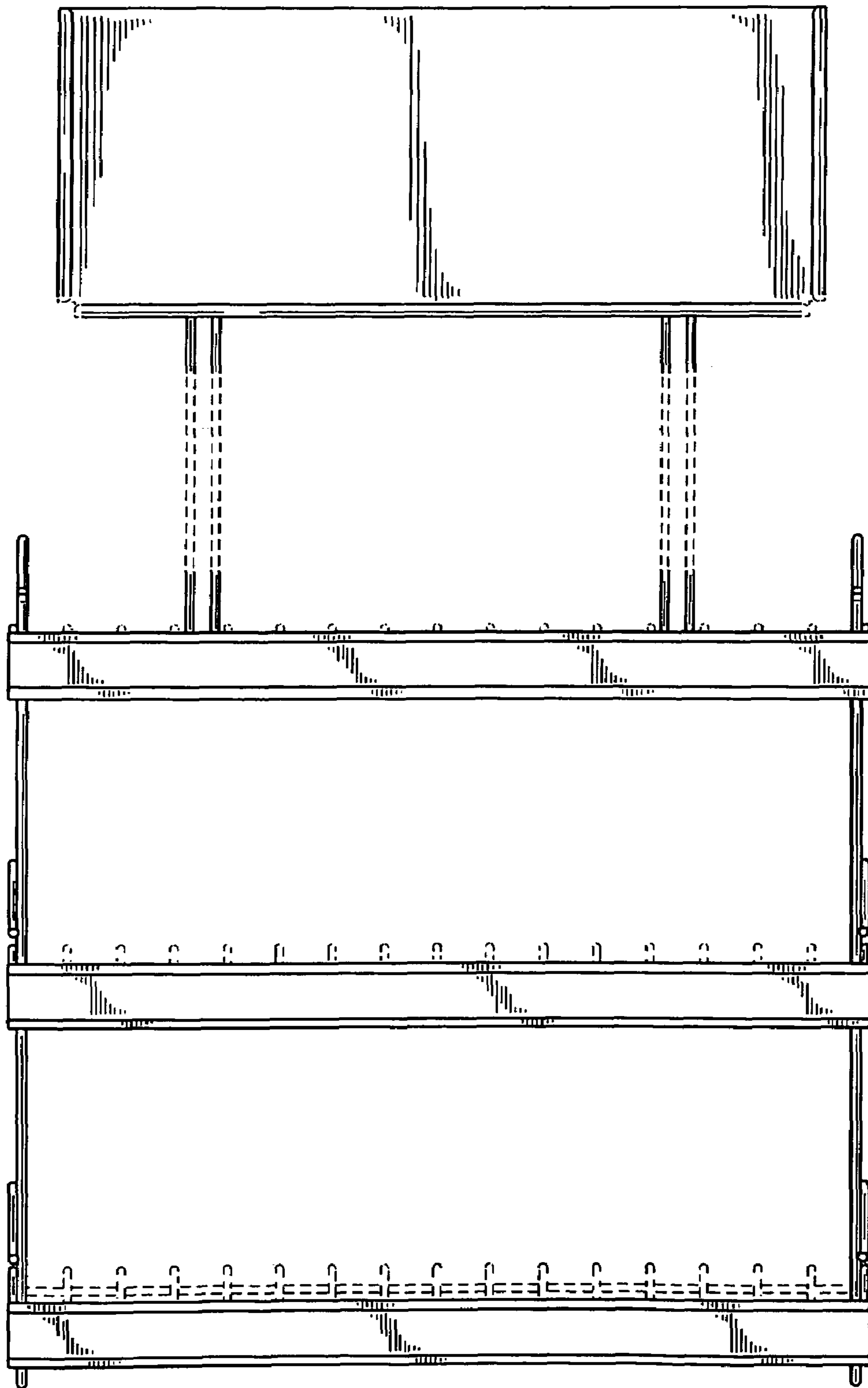
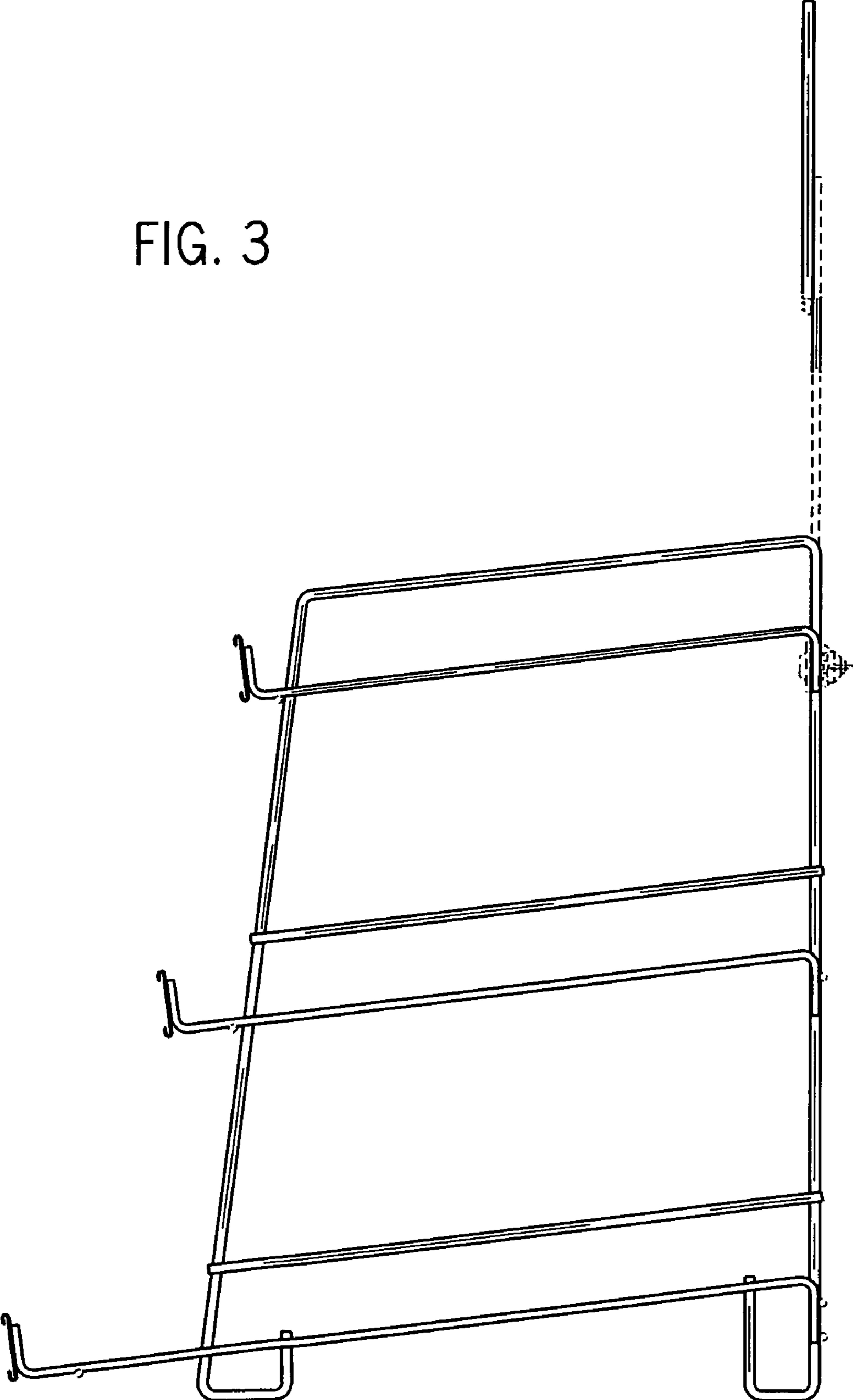

FIG. 3



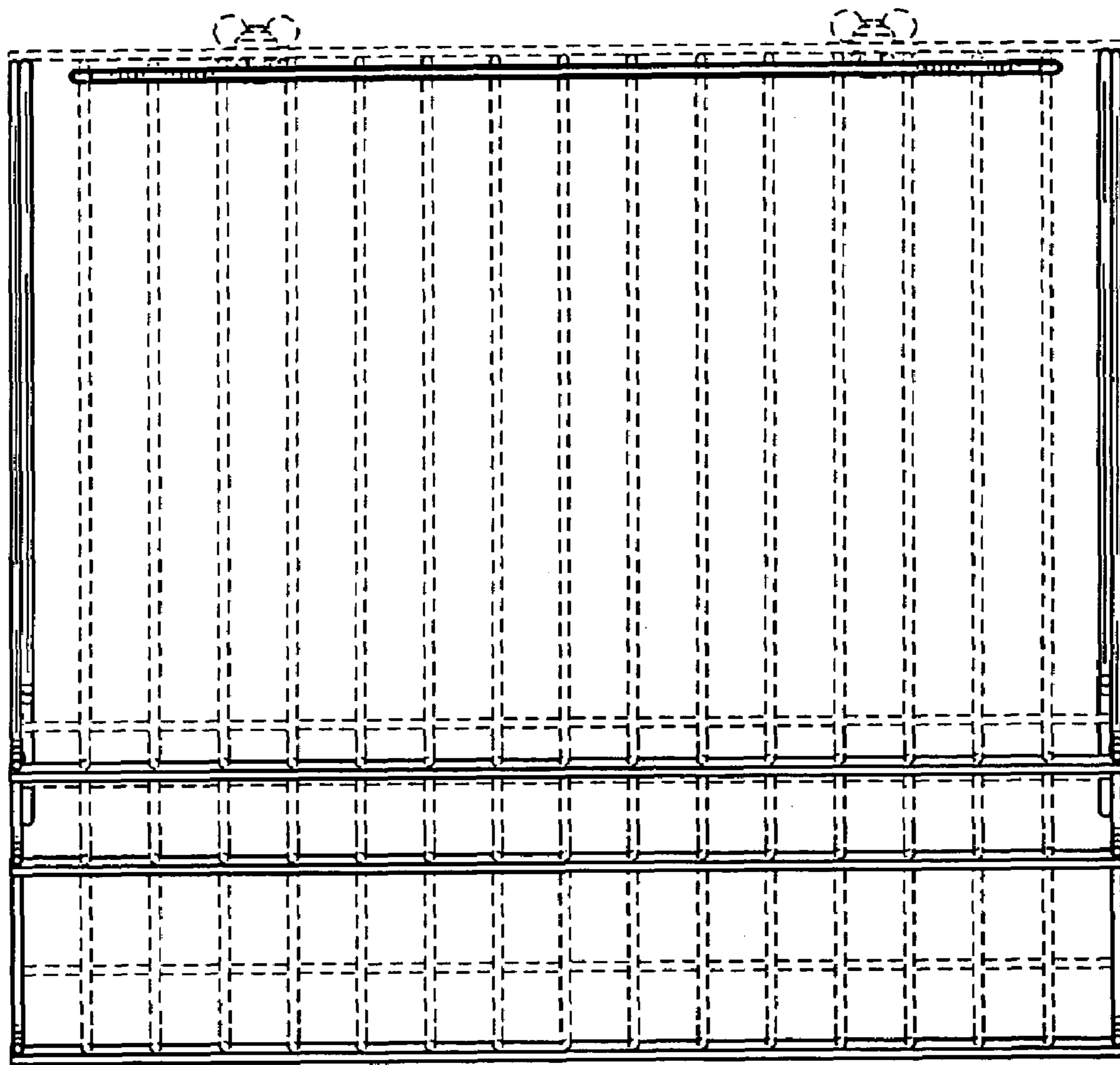
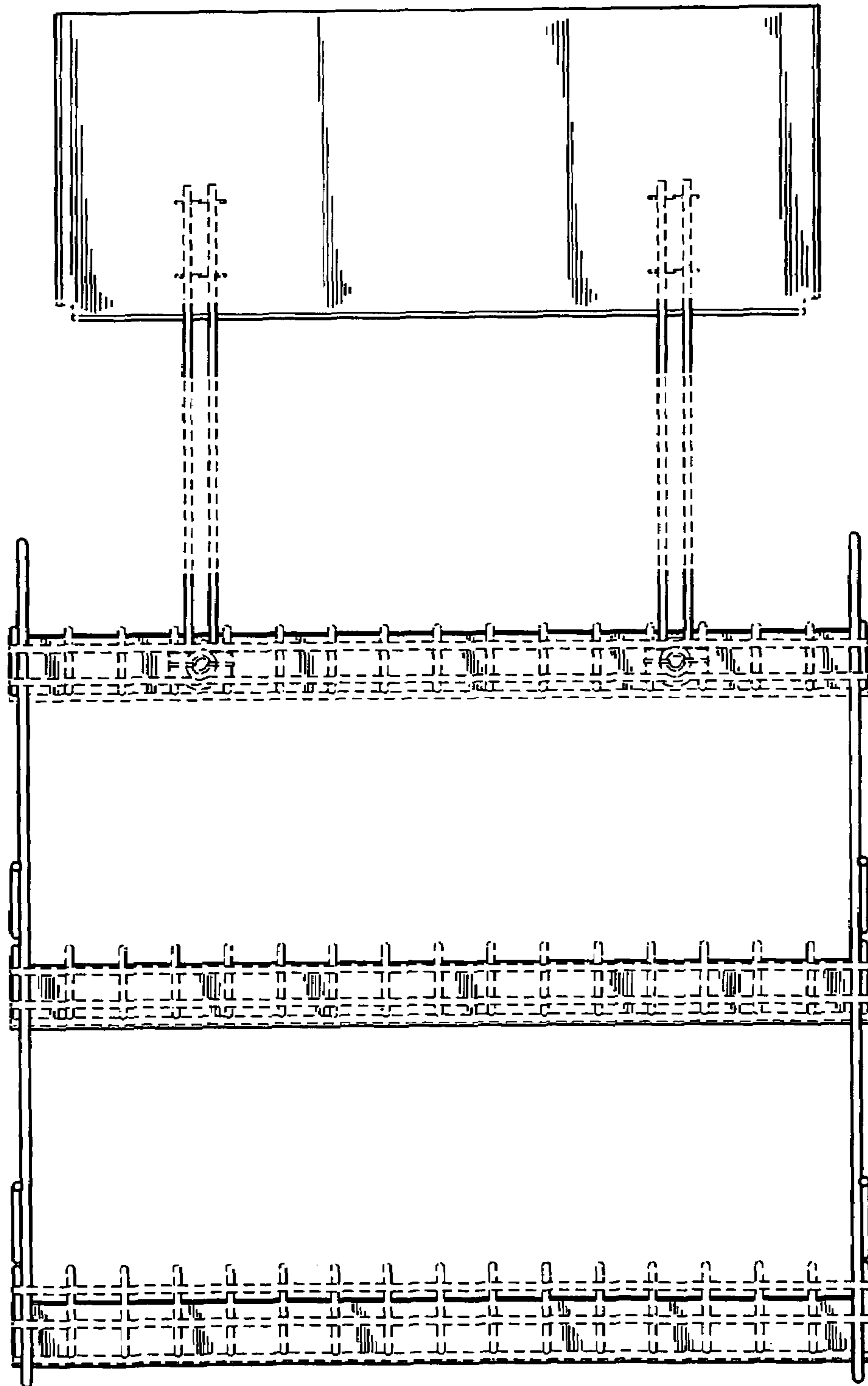

FIG. 4

FIG. 5



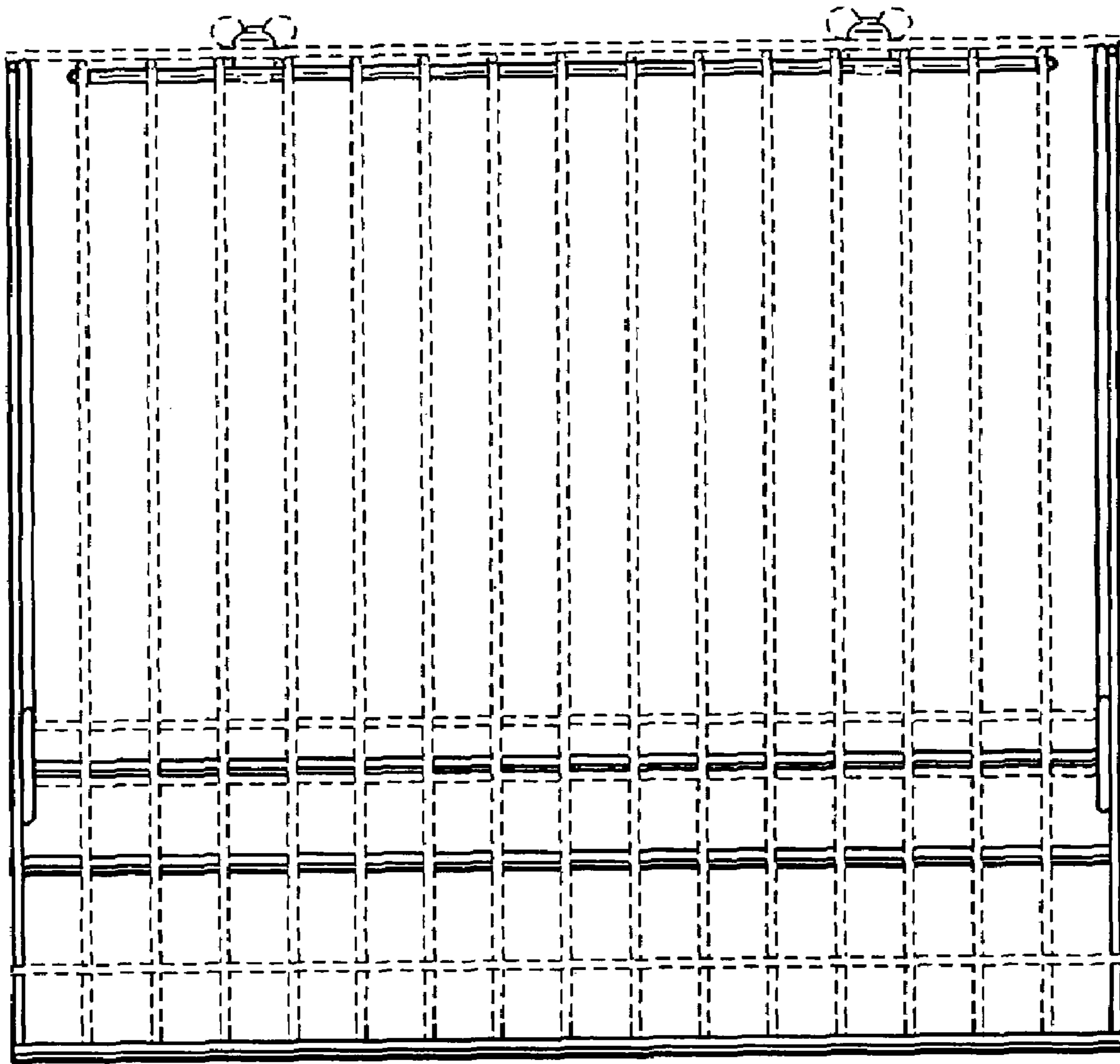

FIG. 6

FIG. 7

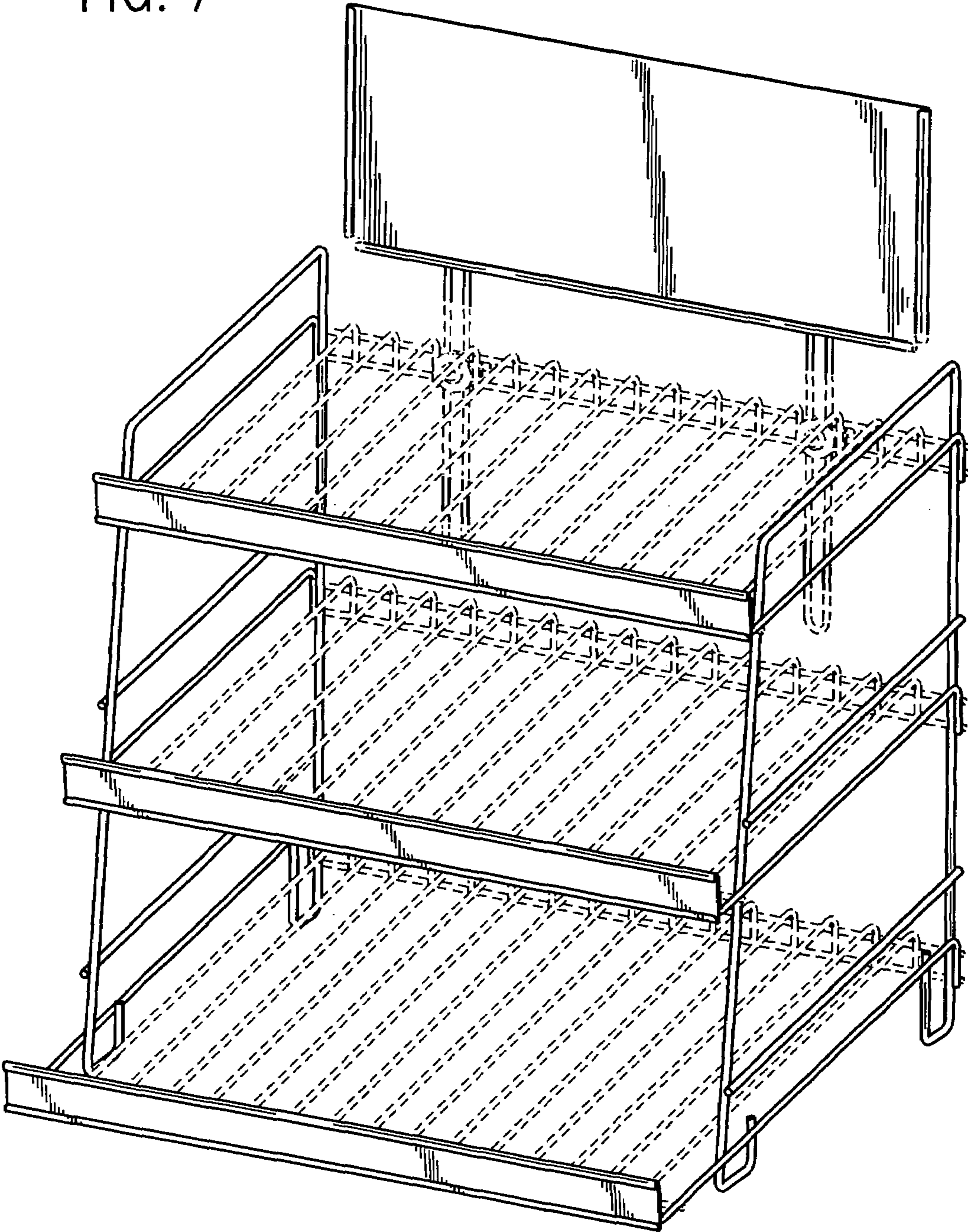

FIG. 8

