



US00D580074S

(12) **United States Design Patent**  
**Taylor**

(10) **Patent No.:** **US D580,074 S**  
(45) **Date of Patent:** **\*\* Nov. 4, 2008**

(54) **FIREFLY LIGHT EMITTING DIODE (LED)**

(76) **Inventor:** **Stephen John Taylor**, 13009 Rincon Rd., Apple Valley, CA (US) 92308

(\*\*) **Term:** **14 Years**

(21) **Appl. No.:** **29/303,892**

(22) **Filed:** **Feb. 20, 2008**

(51) **LOC (8) Cl.** ..... **26-99**

(52) **U.S. Cl.** ..... **D26/24; D11/117**

(58) **Field of Classification Search** ..... D26/24,  
D26/25, 26, 2, 37, 51, 59, 74, 110, 46, 113,  
D26/138, 72, 73, 98; D3/209; D23/366,  
D23/367, 368, 369; 362/555, 557, 565, 116,  
362/124, 157, 159, 200, 205, 640, 641, 642,  
362/643, 644, 647, 649, 650, 652, 653, 655,  
362/657, 658, 659, 806, 811; D11/117, 130,  
D11/141, 162; D10/114; D21/650; D14/218,  
D14/496

See application file for complete search history.

(56) **References Cited**

**U.S. PATENT DOCUMENTS**

D280,929	S	*	10/1985	Lystager	.....	D24/152
5,034,847	A	*	7/1991	Brain	.....	362/205
5,690,509	A	*	11/1997	Eisenbraun	.....	439/490
D474,551	S	*	5/2003	Gohl et al.	.....	D26/37
D485,389	S	*	1/2004	Weiser et al.	.....	D26/73
D502,969	S	*	3/2005	Weiser	.....	D21/650
D538,451	S	*	3/2007	Waldmann	.....	D26/24
7,212,932	B1	*	5/2007	Taylor	.....	702/66
D552,285	S	*	10/2007	Richmond	.....	D26/73

D562,185	S	*	2/2008	van Wingerden et al.	...	D11/117
D565,216	S	*	3/2008	Markell	.....	D26/37
D565,781	S	*	4/2008	Musina	.....	D26/98
2004/0090795	A1	*	5/2004	Kim	.....	362/555

**OTHER PUBLICATIONS**

Firefly Magic Firefly, Wayback Machine date Oct. 22, 2006, [online], [retrieved on Aug. 27, 2008]. Retrieved from Internet, <URL: <http://web.archive.org/web/20061022214049/http://www.fireflymagic.com/index.html>>.\*

\* cited by examiner

*Primary Examiner*—Jennifer Rivard

*Assistant Examiner*—Angela J Lee

(57) **CLAIM**

I claim the ornamental design for a firefly light emitting diode (LED), as shown and described.

**DESCRIPTION**

FIG. 1 is a perspective view of a firefly light emitting diode (LED) showing the new design;

FIG. 2 is a front elevation view thereof;

FIG. 3 is a rear elevation view thereof;

FIG. 4 is a right side elevation view thereof;

FIG. 5 is a left side elevation view thereof;

FIG. 6 is a top elevation view thereof; and,

FIG. 7 is a bottom elevation view thereof.

The ends of the cables are cut off to indicate that no particular length is claimed.

**1 Claim, 2 Drawing Sheets**

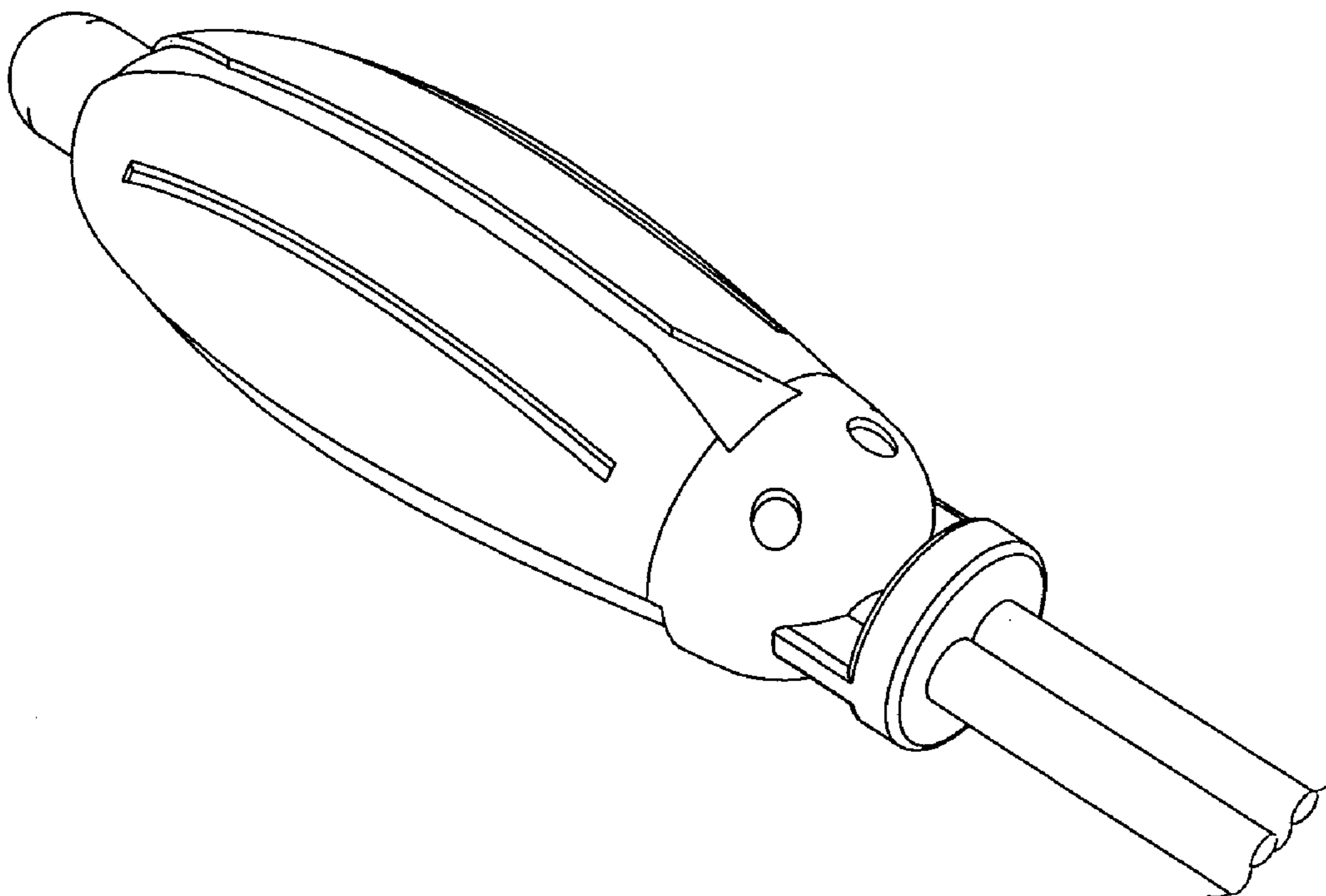

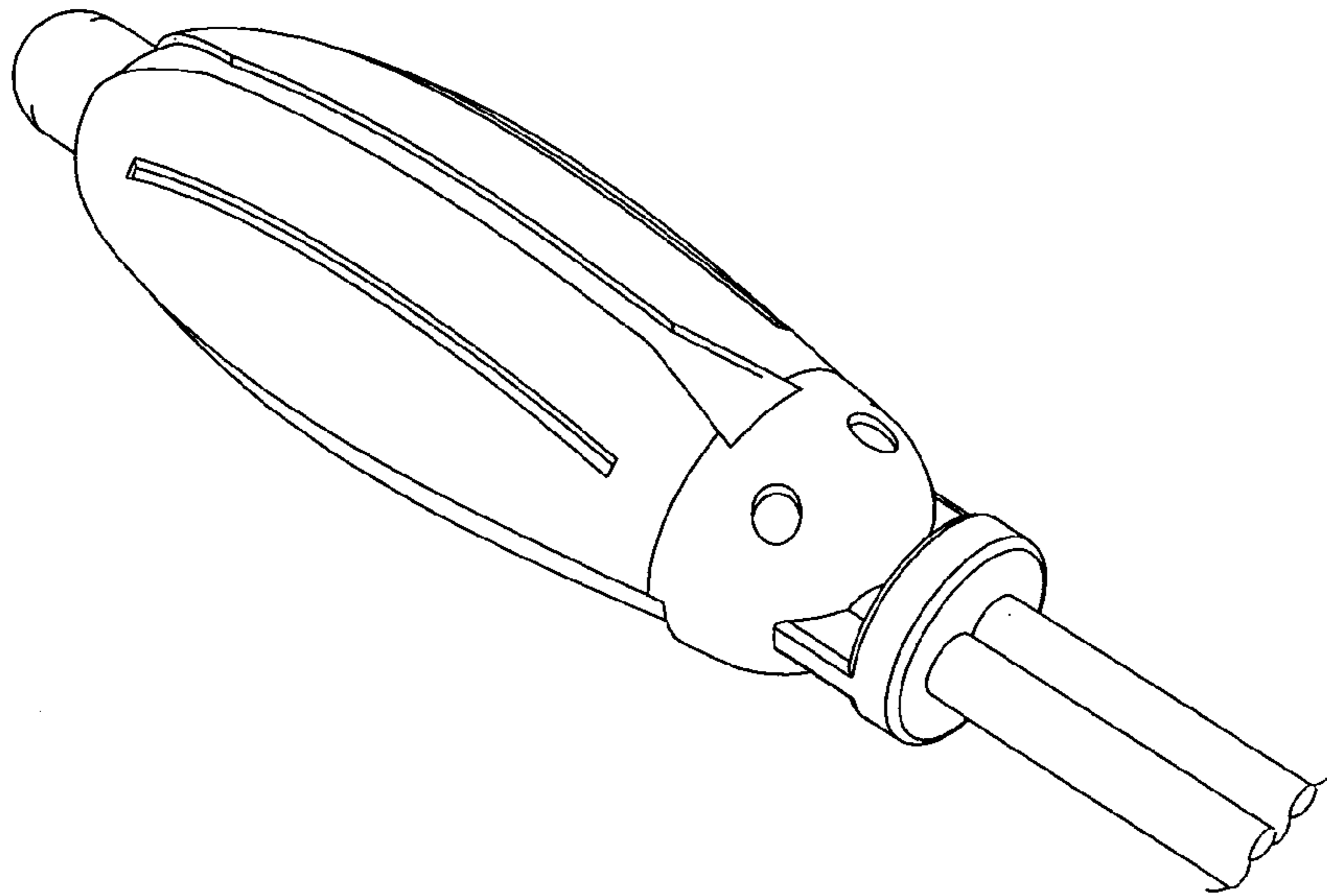

FIG. 1

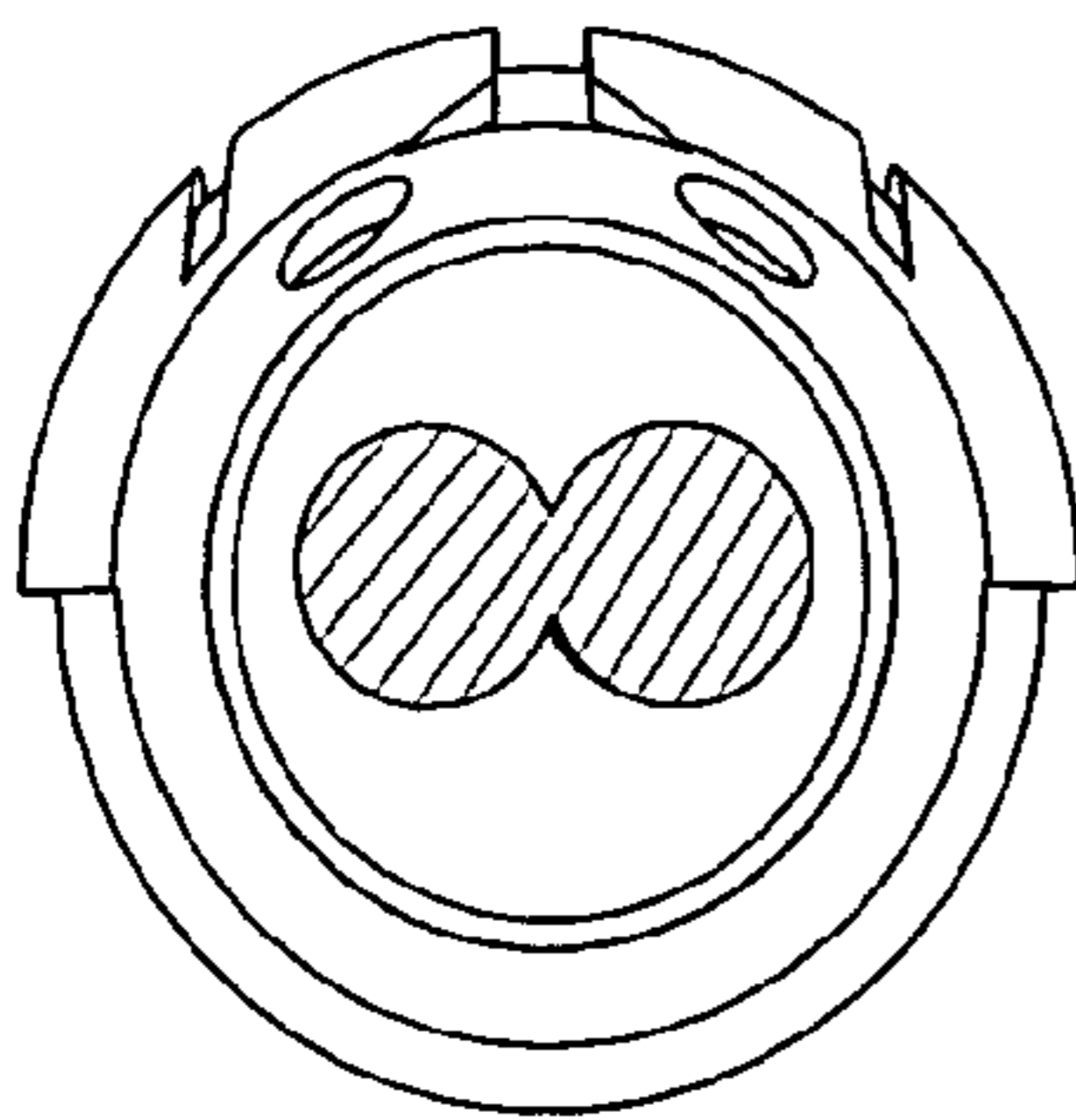

FIG. 2

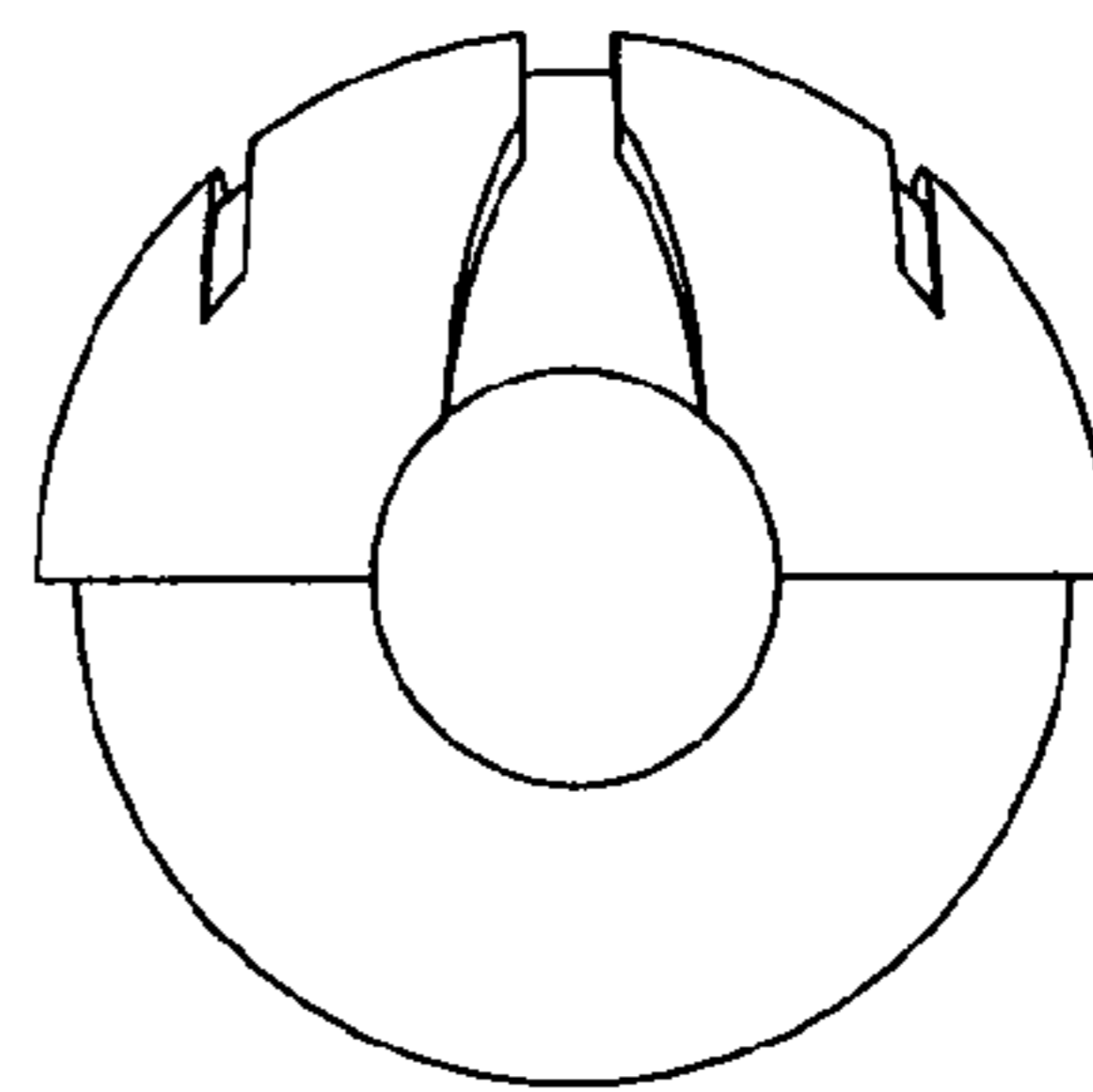

FIG. 3

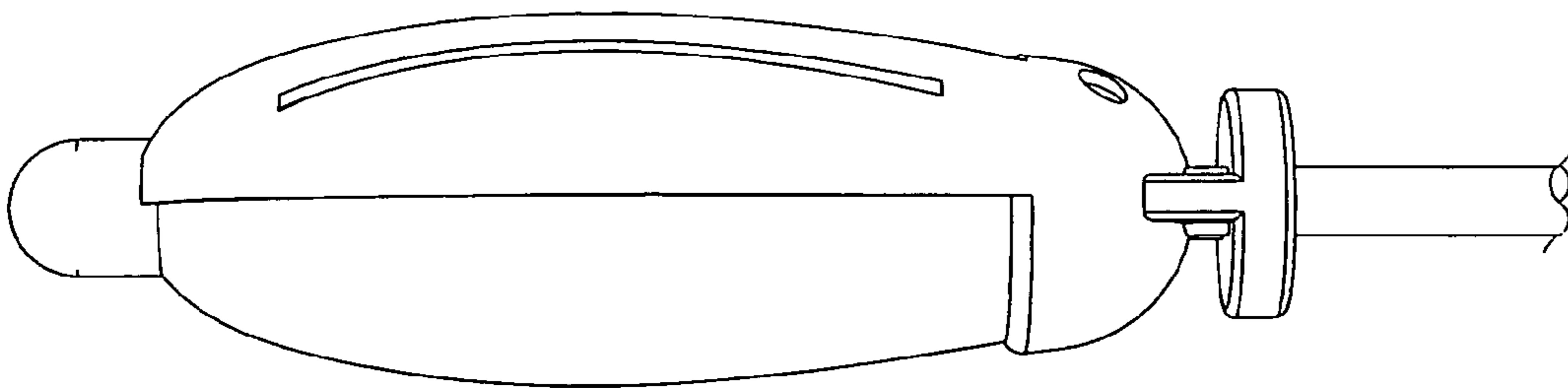

FIG. 4

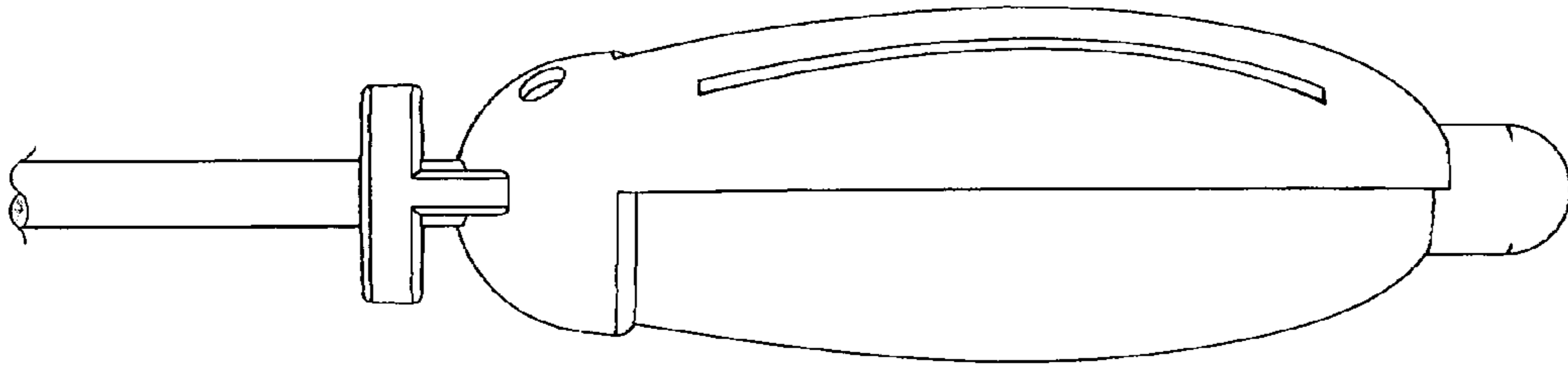

FIG. 5

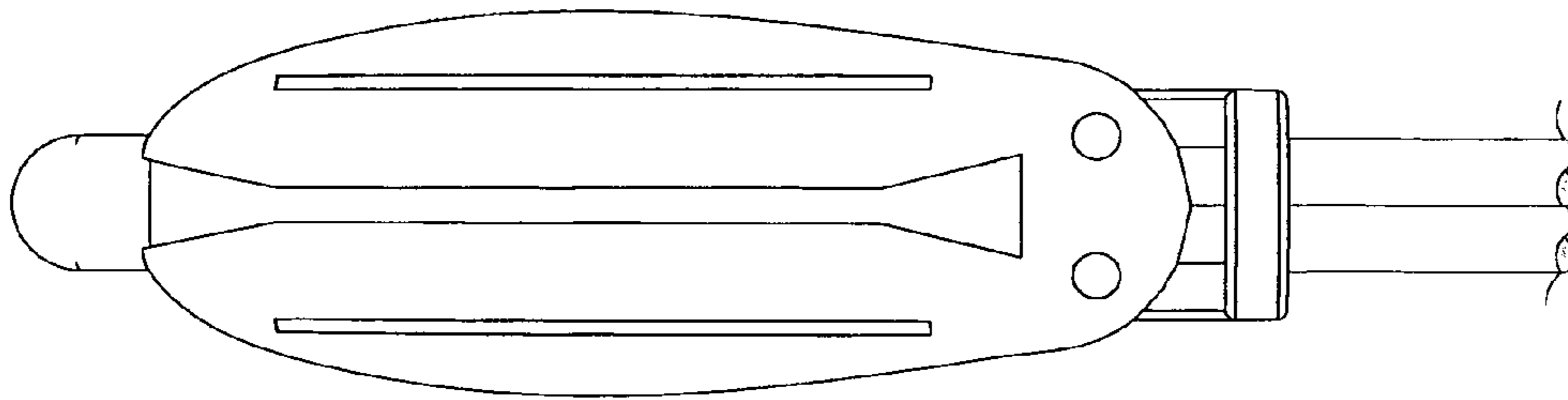

FIG. 6

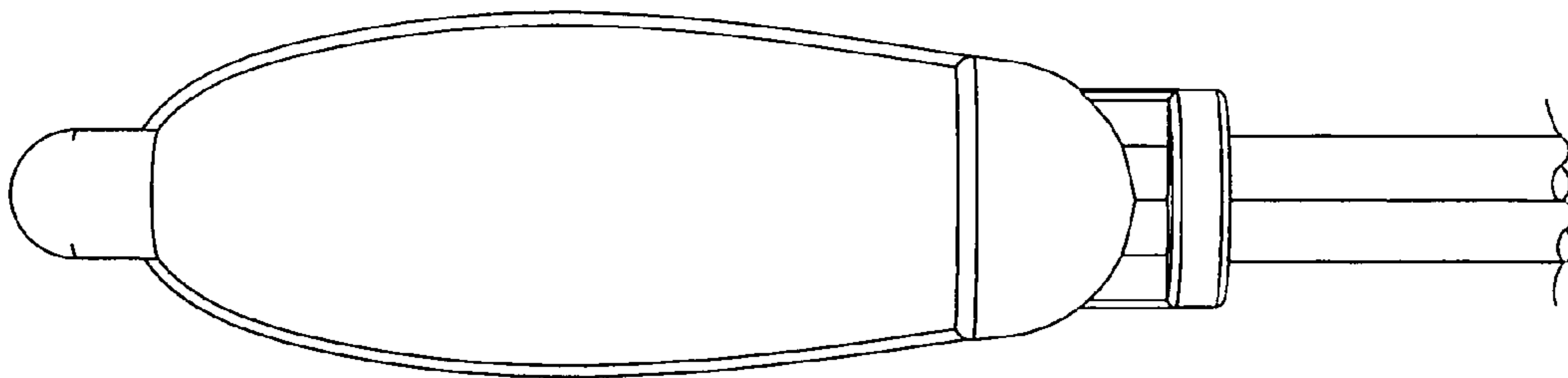

FIG. 7