



US00D580041S

(12) **United States Design Patent**  
**Kudo**

(10) **Patent No.:** **US D580,041 S**  
(45) **Date of Patent:** **\*\* Nov. 4, 2008**

(54) **RANGE HOOD**

(75) Inventor: **Hiroshi Kudo**, Kanagawa-ken (JP)

(73) Assignee: **Fuji Industrial Co., Ltd.**,  
Kanagawa-ken (JP)

(\*\*) Term: **14 Years**

(21) Appl. No.: **29/298,368**

(22) Filed: **Dec. 4, 2007**

**Related U.S. Application Data**

(62) Division of application No. 29/201,316, filed on Mar. 15, 2004, now Pat. No. Des. 565,718.

(51) **LOC (8) Cl.** ..... **23-04**

(52) **U.S. Cl.** ..... **D23/372**

(58) **Field of Classification Search** ..... D23/372,  
D23/371; 126/299 R, 299 D

See application file for complete search history.

(56) **References Cited**

**U.S. PATENT DOCUMENTS**

3,690,245 A	9/1972	Ferlise et al.
4,506,655 A	3/1985	Kuechler
D325,966 S	5/1992	Wei
D379,501 S	5/1997	Airosa et al.
D390,648 S	2/1998	Woodall, III
D433,495 S	11/2000	Segers
6,216,686 B1	4/2001	Chiu

D443,351 S	6/2001	Strand et al.
D450,829 S	11/2001	Bothe et al.
D452,558 S	12/2001	Tamura
D454,948 S	3/2002	Chiang
D465,021 S	10/2002	Liou
D473,297 S	4/2003	Bothe et al.
D482,769 S	11/2003	Bothe et al.
D565,718 S *	4/2008	Kudo ..... D23/372

\* cited by examiner

*Primary Examiner*—Lisa P Lichtenstein

(74) *Attorney, Agent, or Firm*—Greenblum & Bernstein, P.L.C.

(57) **CLAIM**

I claim the ornamental design for a range hood, as shown and described.

**DESCRIPTION**

FIG. 1 is a top plan view of a range hood, showing my new design;

FIG. 2 is a bottom plan view of the embodiment of FIG. 1;

FIG. 3 is a left side elevational view of the embodiment of FIG. 1, the right side being a mirror image of the left side;

FIG. 4 is a front elevational view of the embodiment of FIG. 1;

FIG. 5 is a rear elevational view of the embodiment of FIG. 1; and,

FIG. 6 is a perspective view of the embodiment of FIG. 1.

**1 Claim, 3 Drawing Sheets**

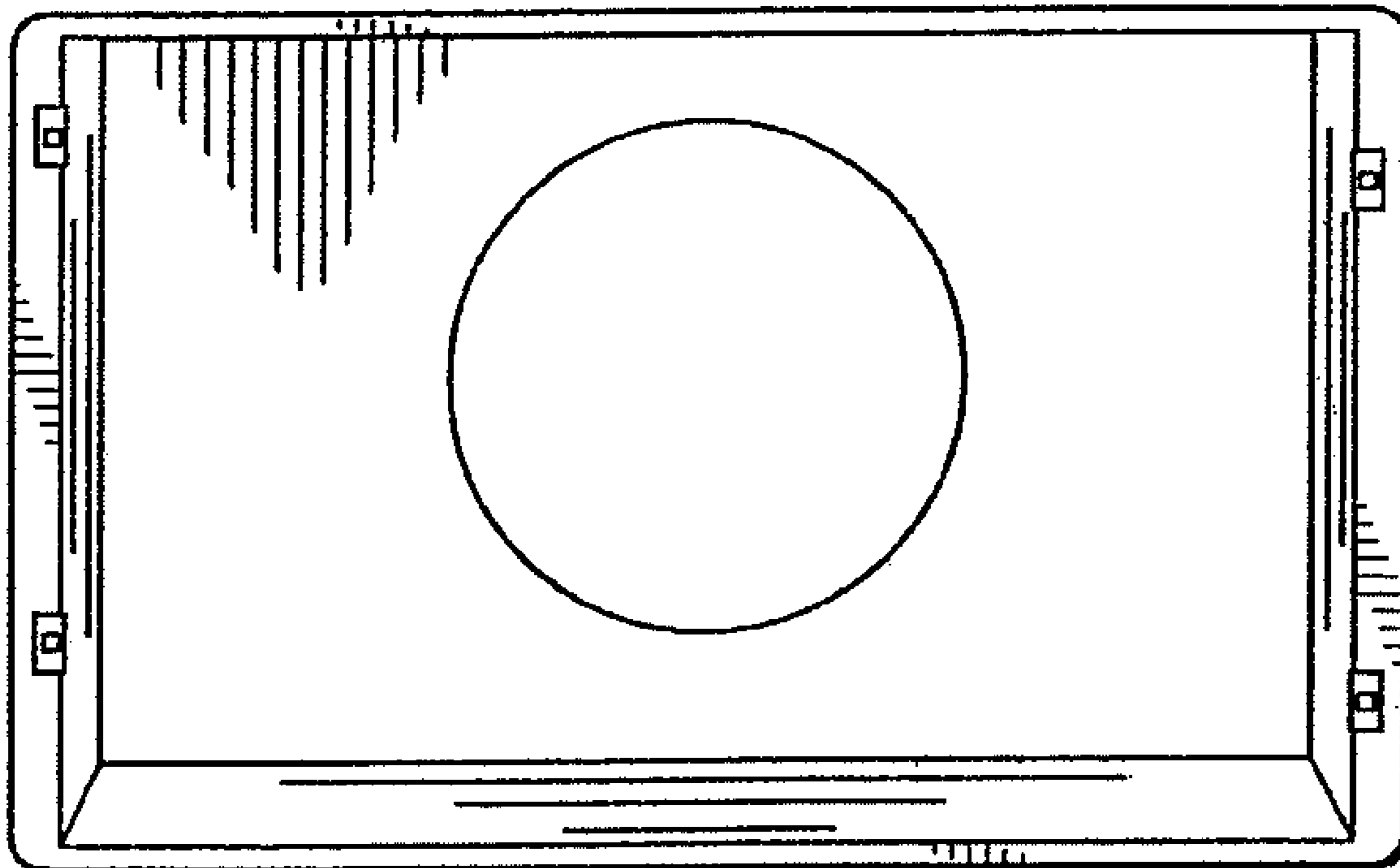

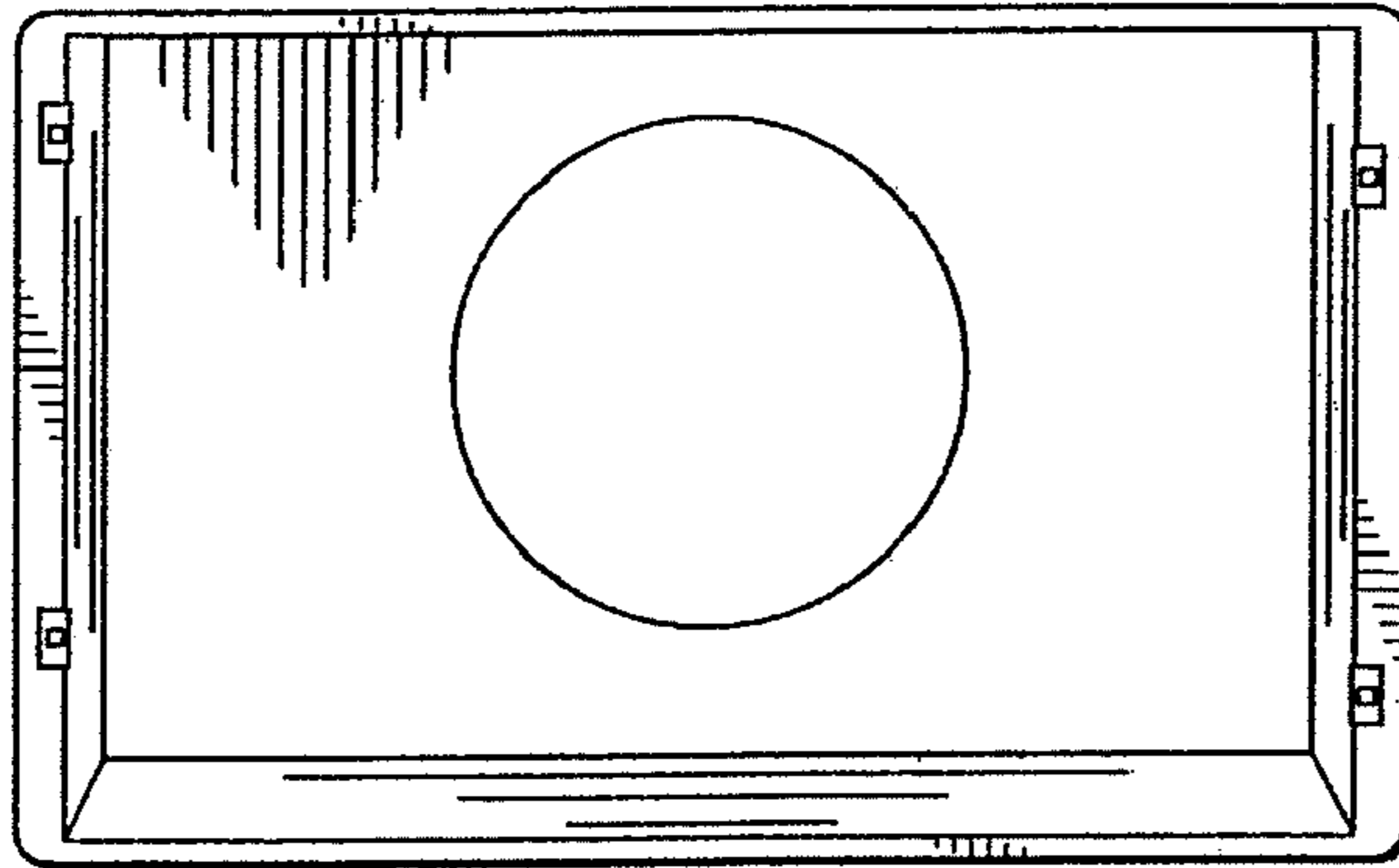

FIG. 1

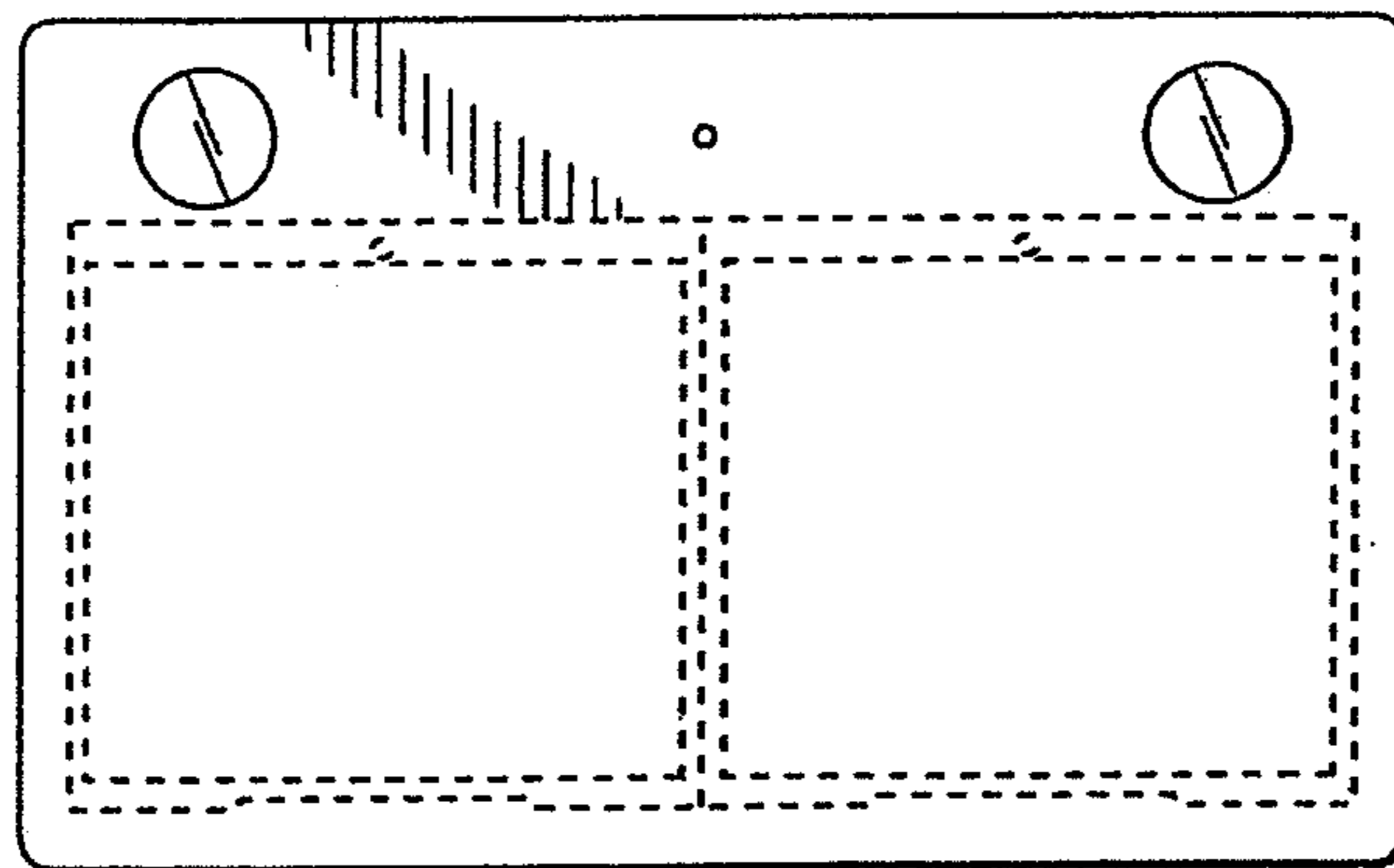

FIG. 2

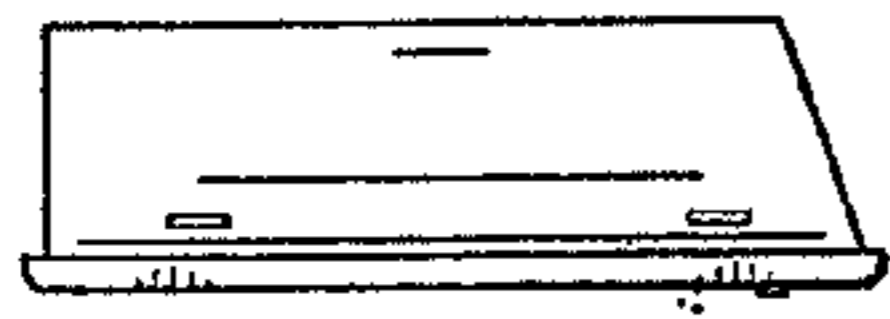

FIG. 3

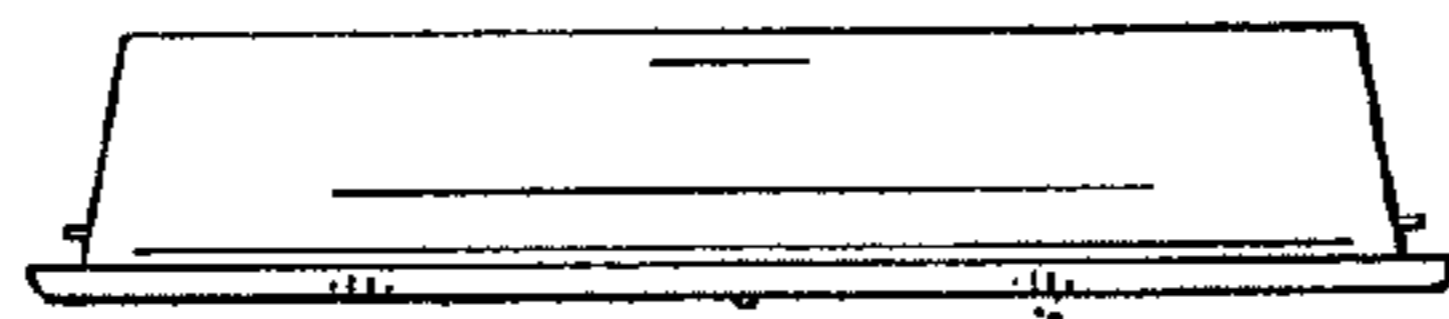

FIG. 4

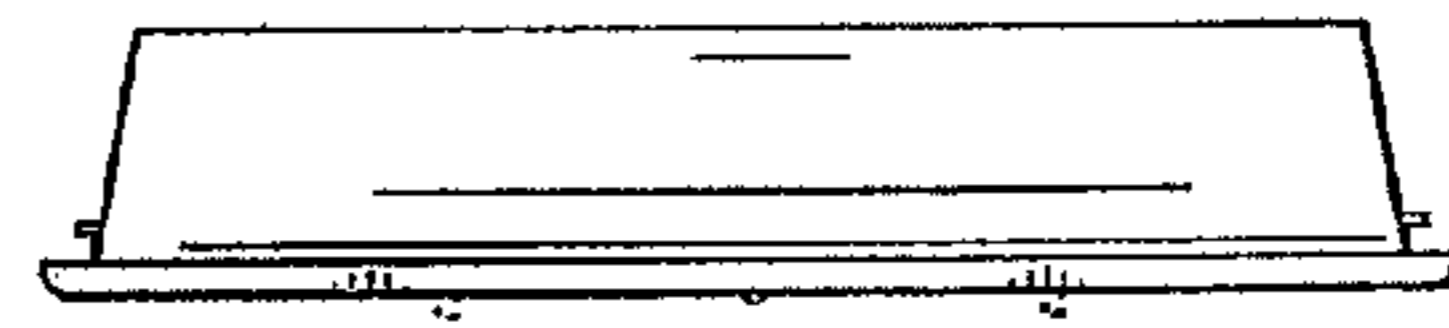

FIG. 5

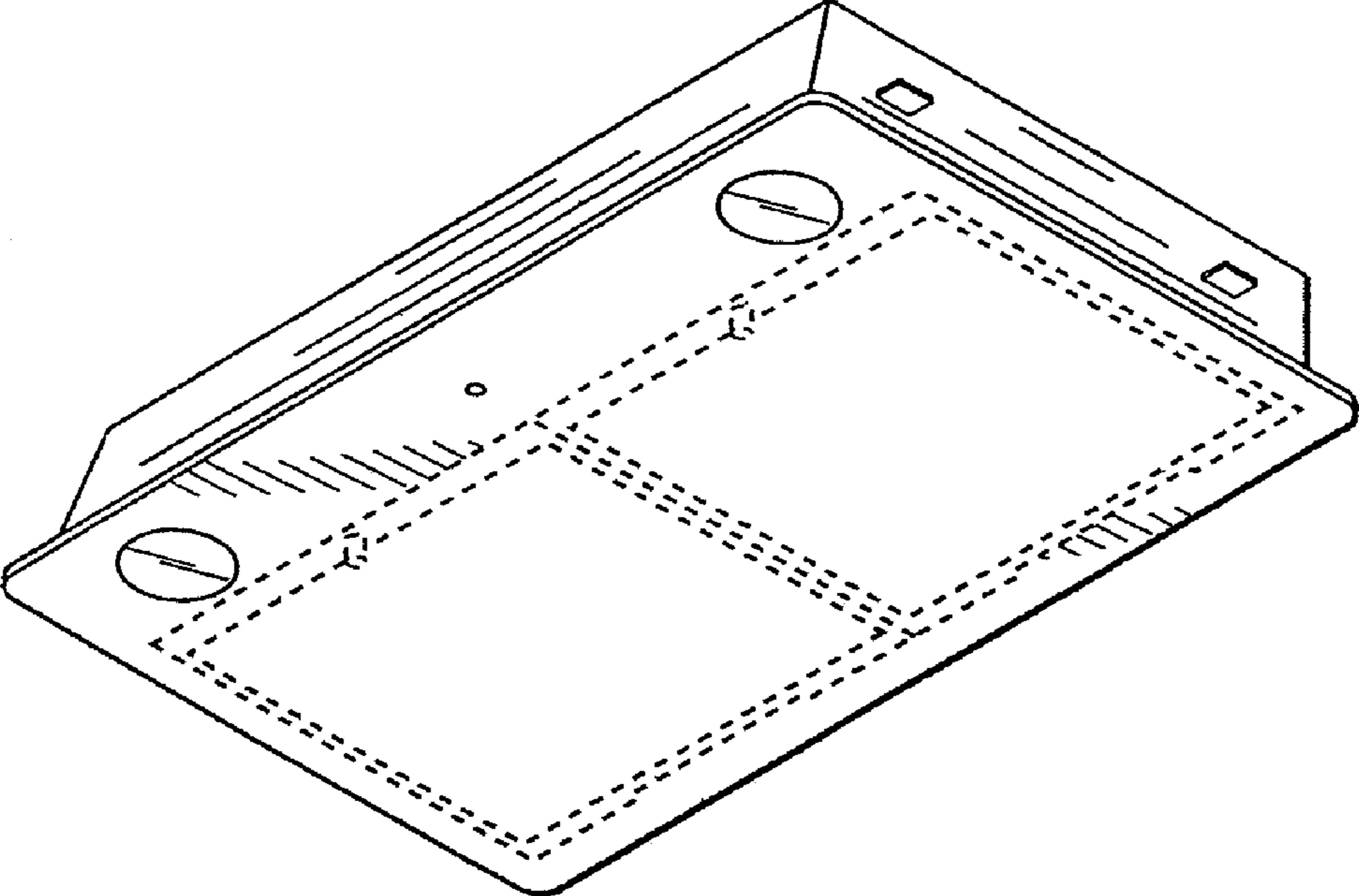

FIG. 6