



US00D579976S

(12) **United States Design Patent**  
**Lorenzati**

(10) **Patent No.:** **US D579,976 S**

(45) **Date of Patent:** **\*\* Nov. 4, 2008**

(54) **BOOK MARK**

(75) Inventor: **Javier A. Lorenzati**, Barcelona (ES)

(73) Assignee: **Nixiface, a Series of the Invention Machine, LLC**, Glencoe, IL (US)

(\*\*) Term: **14 Years**

(21) Appl. No.: **29/320,340**

(22) Filed: **Jun. 25, 2008**

(51) **LOC (8) Cl.** ..... **19-99**

(52) **U.S. Cl.** ..... **D19/34**

(58) **Field of Classification Search** ..... D19/1,  
D19/2, 34, 32, 65; D11/78.1, 223; D9/600;  
D3/253, 247; 116/238, 239, 240, 234, 235;  
24/67 R; 281/142; 40/124.01

See application file for complete search history.

*Primary Examiner*—Cathron C Brooks

*Assistant Examiner*—Austin Murphy

(74) *Attorney, Agent, or Firm*—Levenfeld Pearlstein, LLC

(57) **CLAIM**

The ornamental design for a book mark, as shown and described.

**DESCRIPTION**

FIG. 1 is a front perspective view of a book mark;

FIG. 2 is a front view thereof;

FIG. 3 is a top view thereof;

FIG. 4 is a side view thereof, as seen from the left-hand side of FIG. 2;

FIG. 5 is a side view thereof, as seen from the right-hand side of FIG. 2;

FIG. 6 is a bottom thereof;

FIG. 7 is a rear view thereof; and,

FIG. 8 is a perspective view of the book mark shown on a book for illustrative purpose, the book forming no part of the claimed design.

The bookmark is shown with portions cut away to indicate no specific length.

**1 Claim, 1 Drawing Sheet**

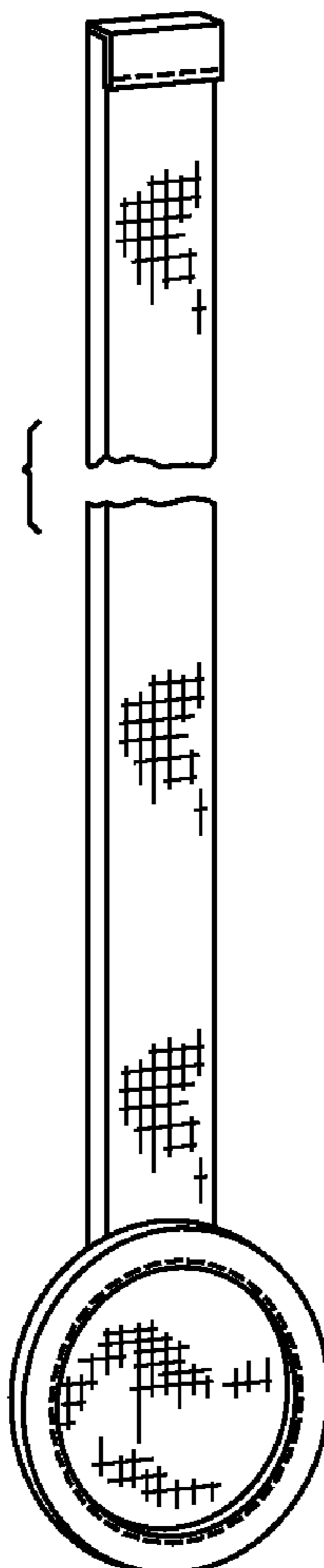

Fig. 1

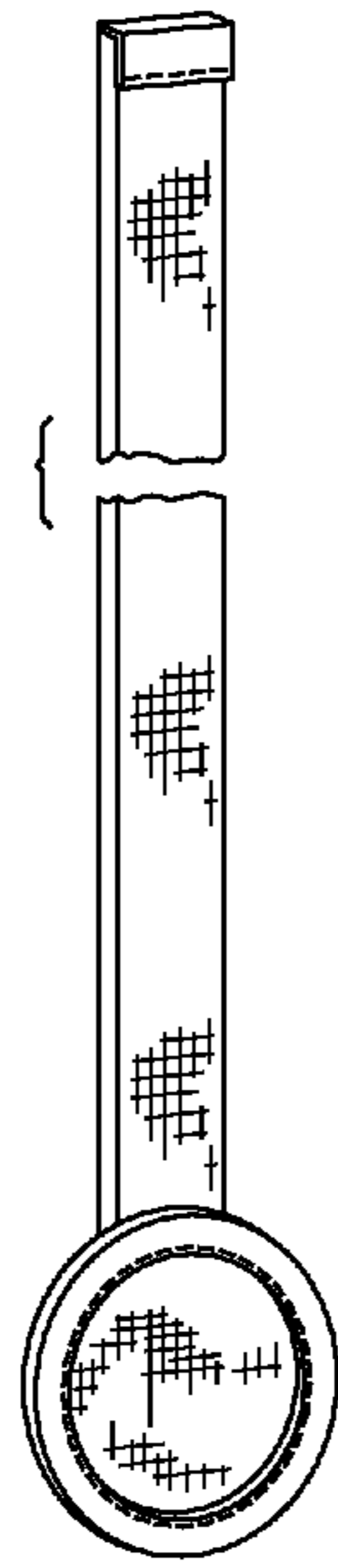

Fig. 8

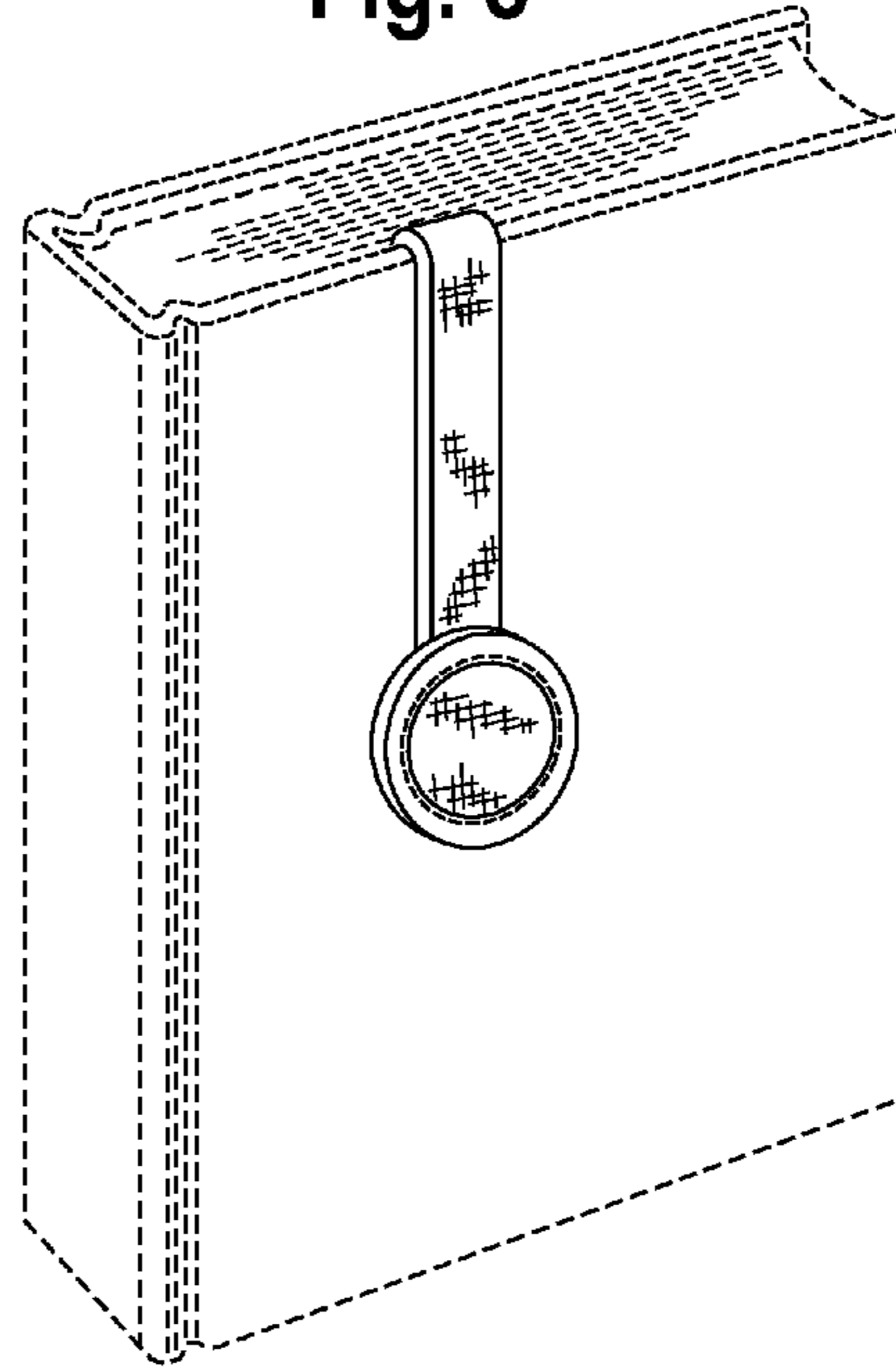

Fig. 3

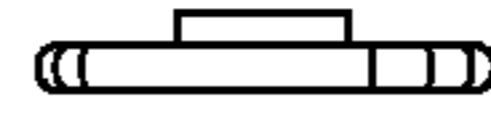

Fig. 4

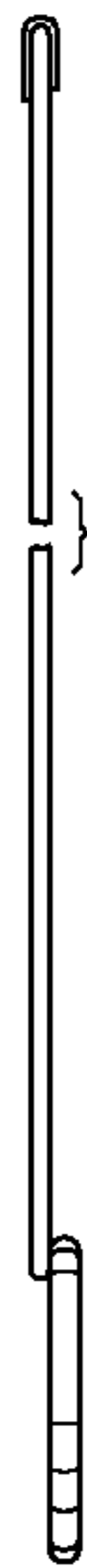

Fig. 2

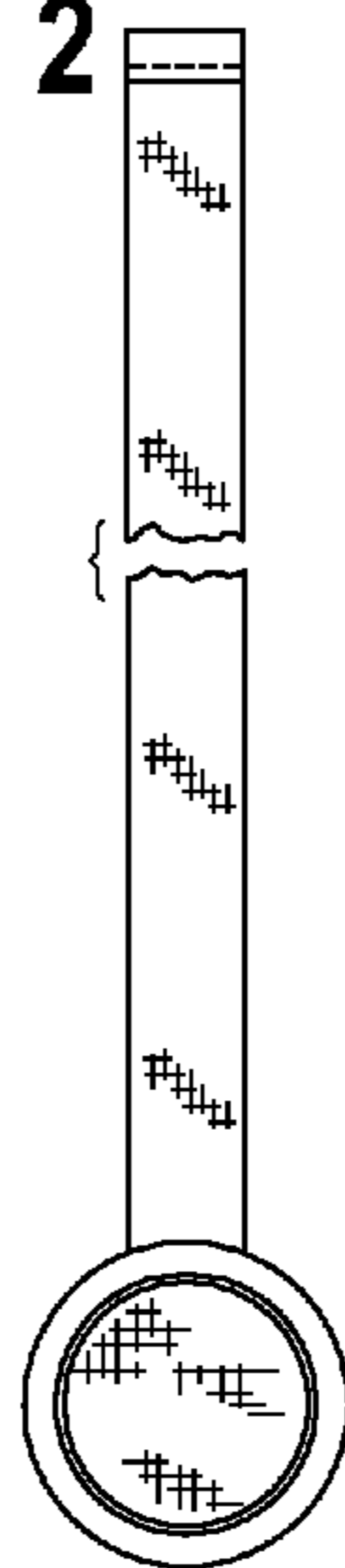

Fig. 5

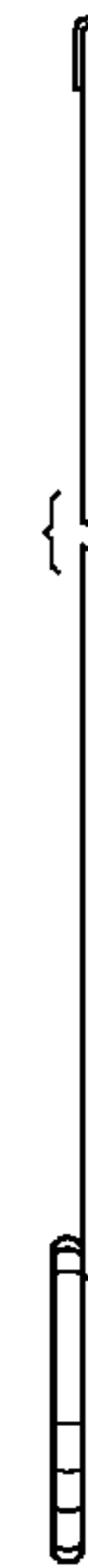

Fig. 7

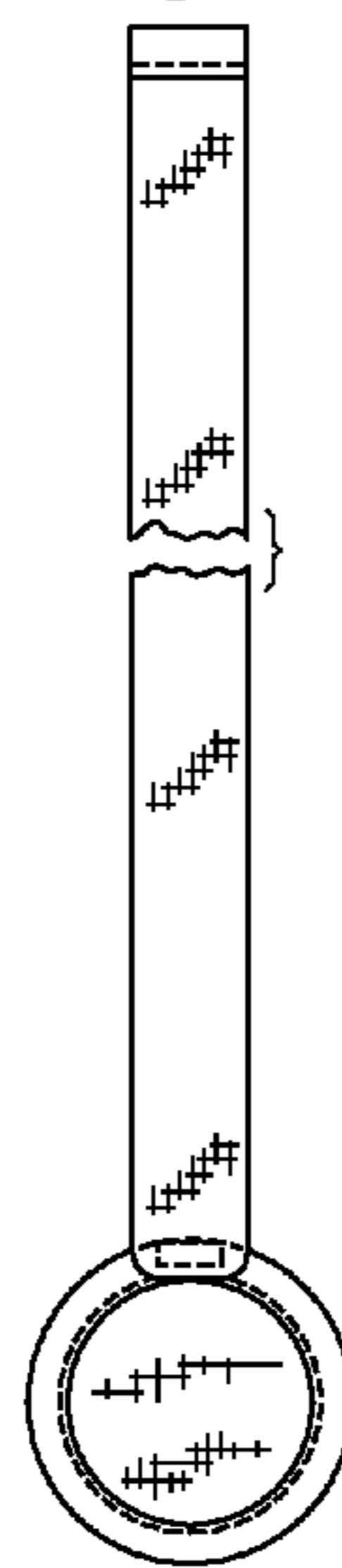

Fig. 6

