



US00D579953S

(12) **United States Design Patent**  
**Chen**

(10) **Patent No.:** **US D579,953 S**

(45) **Date of Patent:** **\*\* Nov. 4, 2008**

(54) **DIGITAL AUDIO PLAYER**

(75) Inventor: **Weisong Chen**, Shenzhen (CN)

(73) Assignee: **Shenzhen Sky Dragon Audio-Video Technology Co., Ltd.**, Shenzhen (CN)

(\*\*) Term: **14 Years**

(21) Appl. No.: **29/280,995**

(22) Filed: **Jun. 13, 2007**

(51) **LOC (8) Cl.** ..... **14-03**

(52) **U.S. Cl.** ..... **D14/496**

(58) **Field of Classification Search** ..... D14/496,  
D14/401, 435, 474, 483, 217, 137, 138, 160,  
D14/168; 345/156, 169, 173-179, 905; 715/727-729,  
715/864; 455/11.1, 7, 73, 344-347, 93, 95;  
370/342-344; 369/1, 2, 6, 12; 463/43-47;  
273/148 B

See application file for complete search history.

(56) **References Cited**

**U.S. PATENT DOCUMENTS**

D513,266 S \* 12/2005 Shimizu ..... D14/496

D519,522 S \* 4/2006 Lee ..... D14/496  
D530,306 S \* 10/2006 Wang et al. .... D14/189  
D542,303 S \* 5/2007 Cheng ..... D14/496  
D552,127 S \* 10/2007 Song ..... D14/496  
7,283,880 B2 \* 10/2007 Dick ..... 700/94

\* cited by examiner

*Primary Examiner*—Prabhakar Deshmukh

(57) **CLAIM**

The ornamental design for a digital audio player, as shown and described.

**DESCRIPTION**

FIG. 1 is a front elevational view of a digital audio player showing my new design;

FIG. 2 is a rear elevational view thereof;

FIG. 3 is a bottom plan view thereof;

FIG. 4 is a top plan view thereof;

FIG. 5 is a left side view thereof; and,

FIG. 6 is a right side view thereof.

The broken lines shown form no part of the claimed design.

**1 Claim, 5 Drawing Sheets**

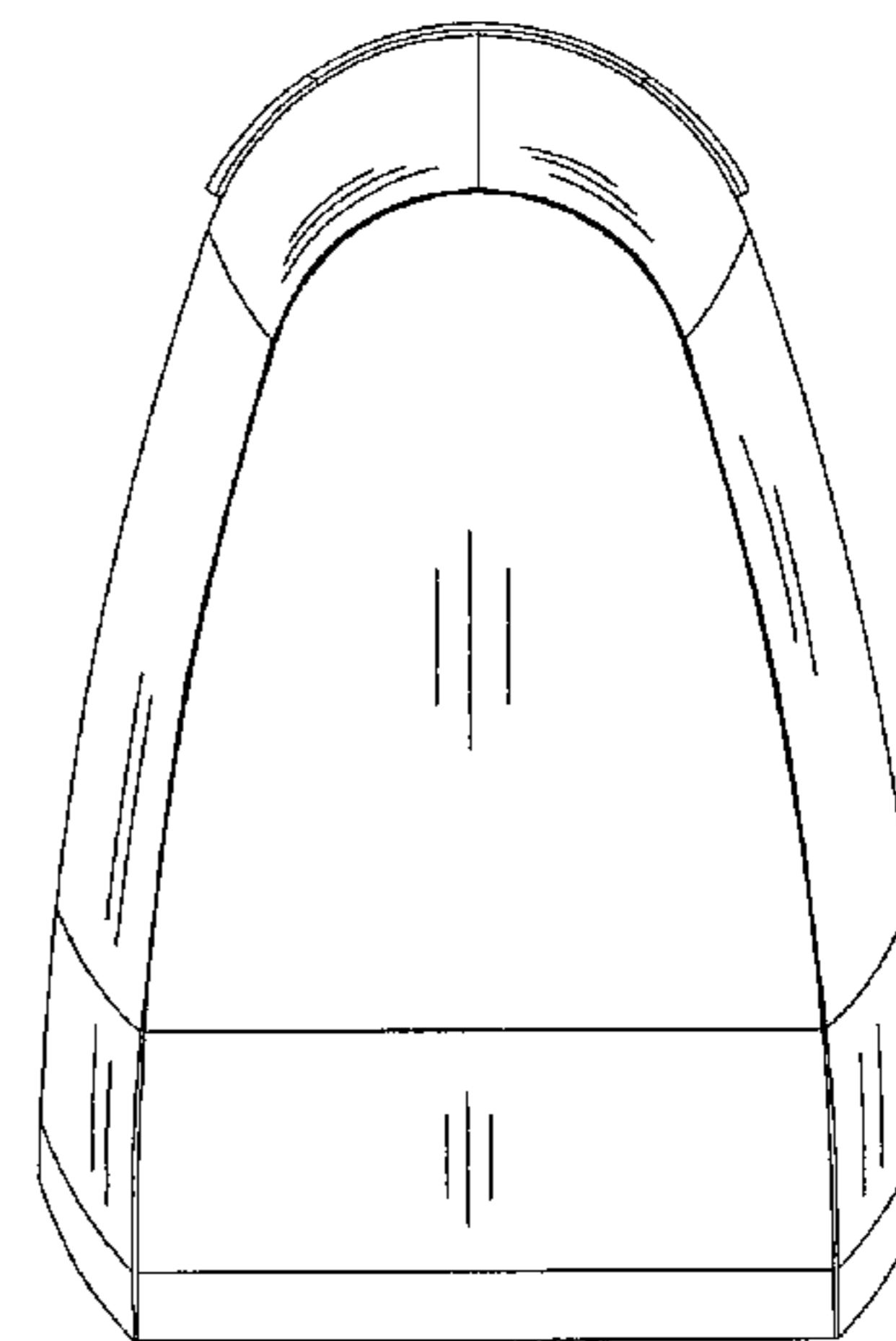
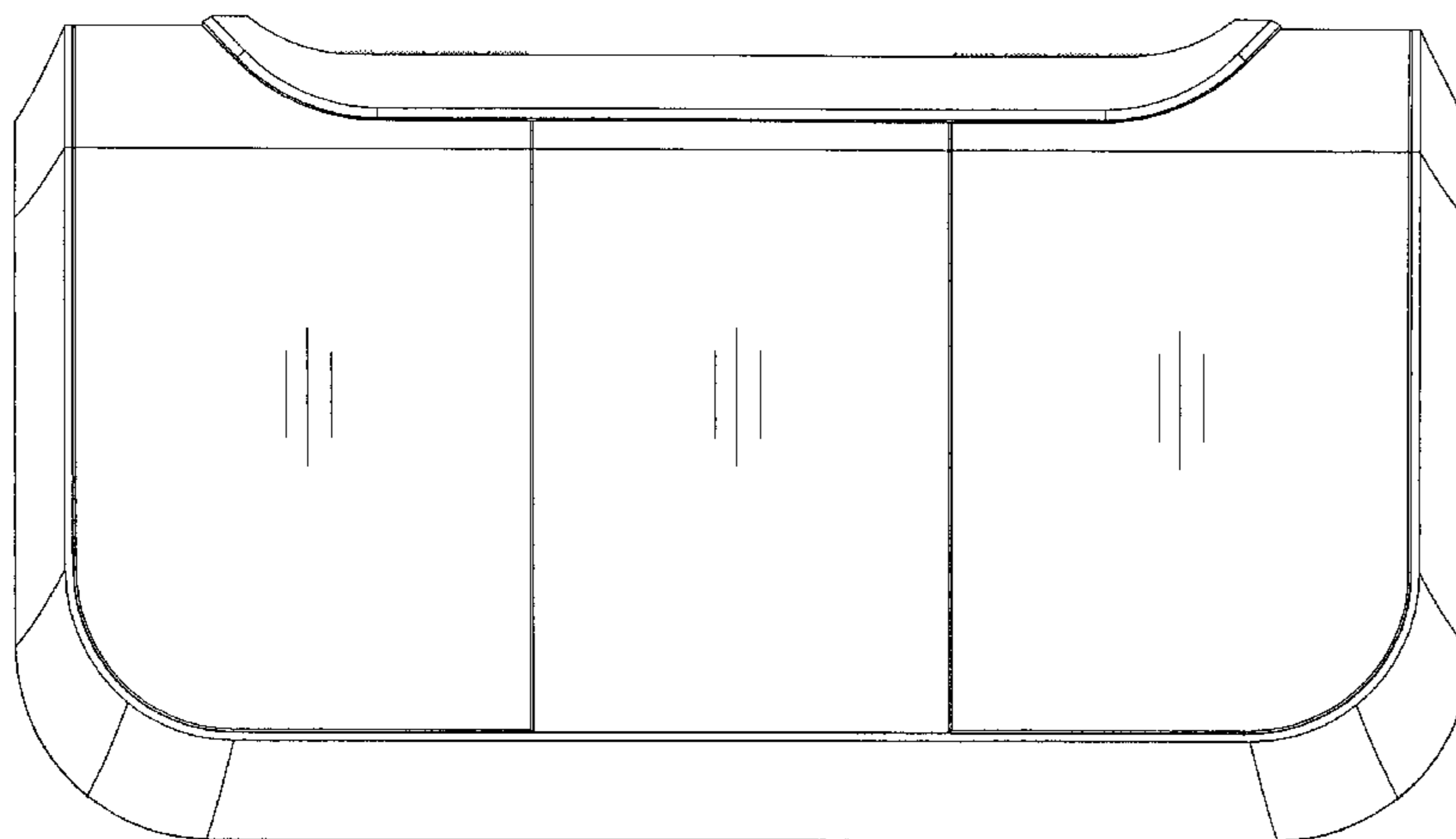

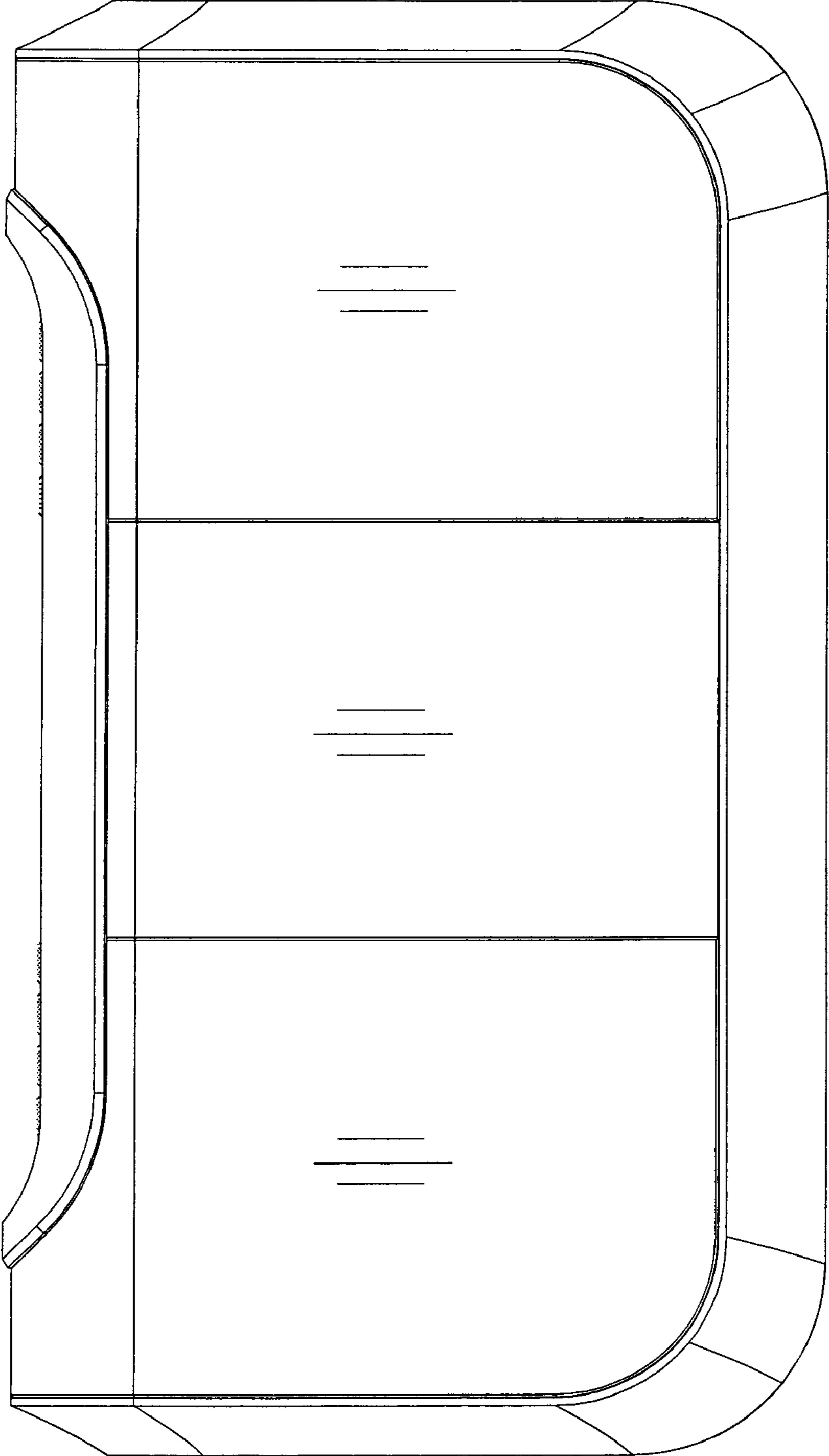

FIG. 1

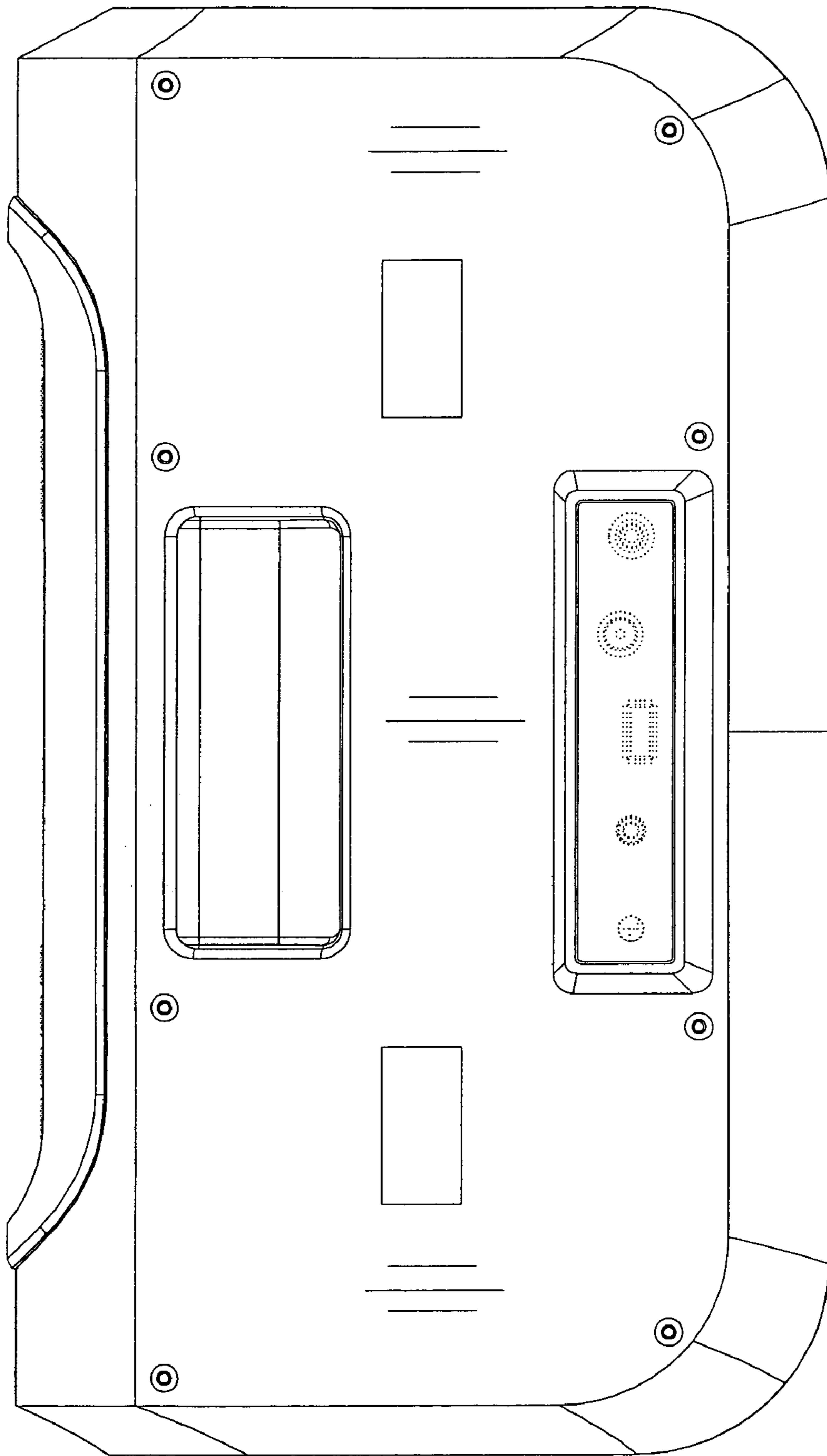

FIG. 2

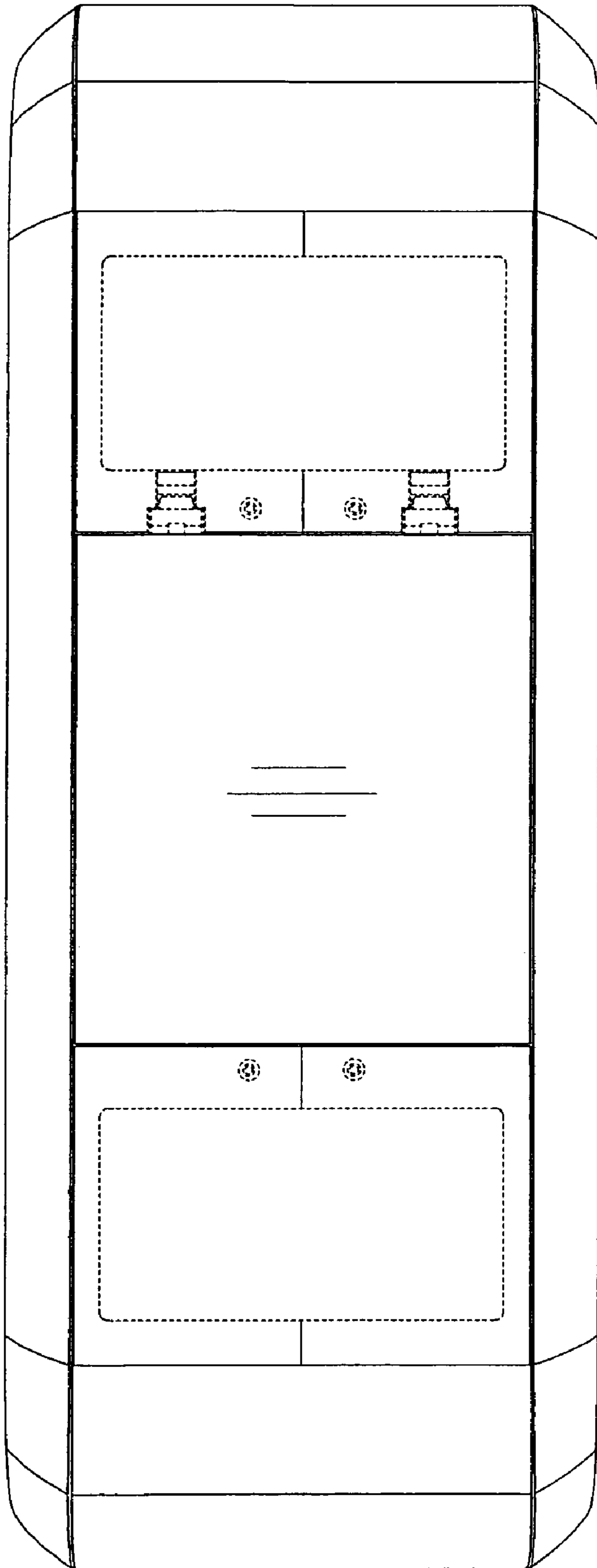

FIG. 3

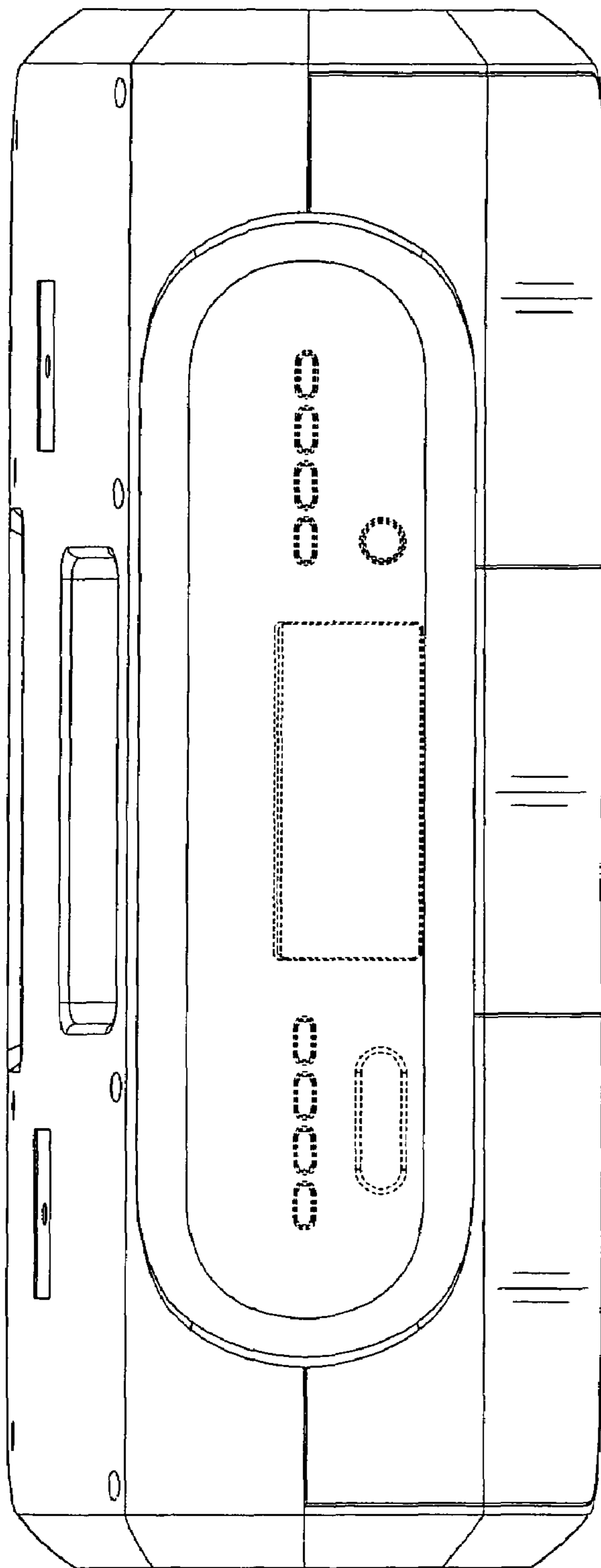

FIG. 4

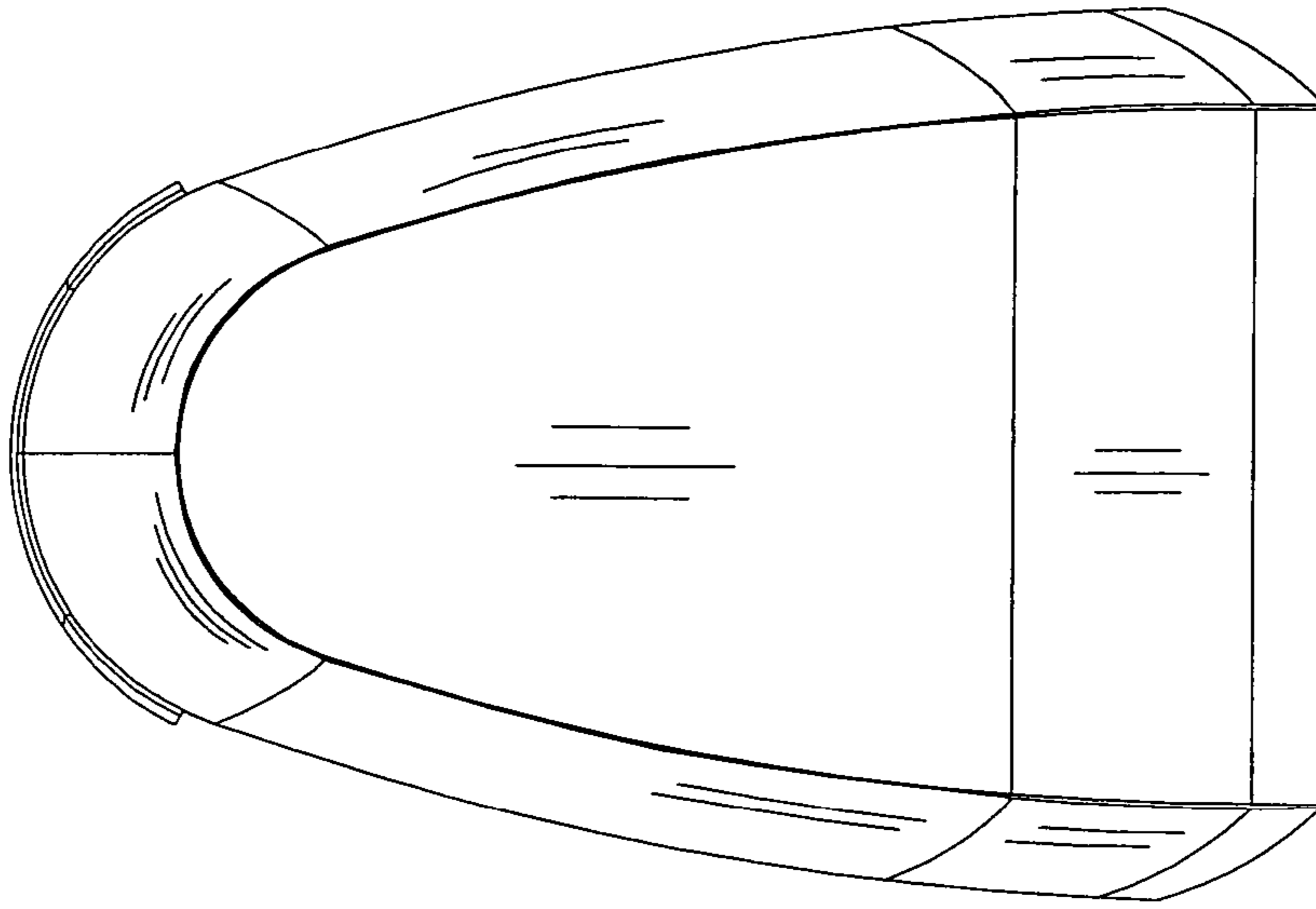

FIG. 6

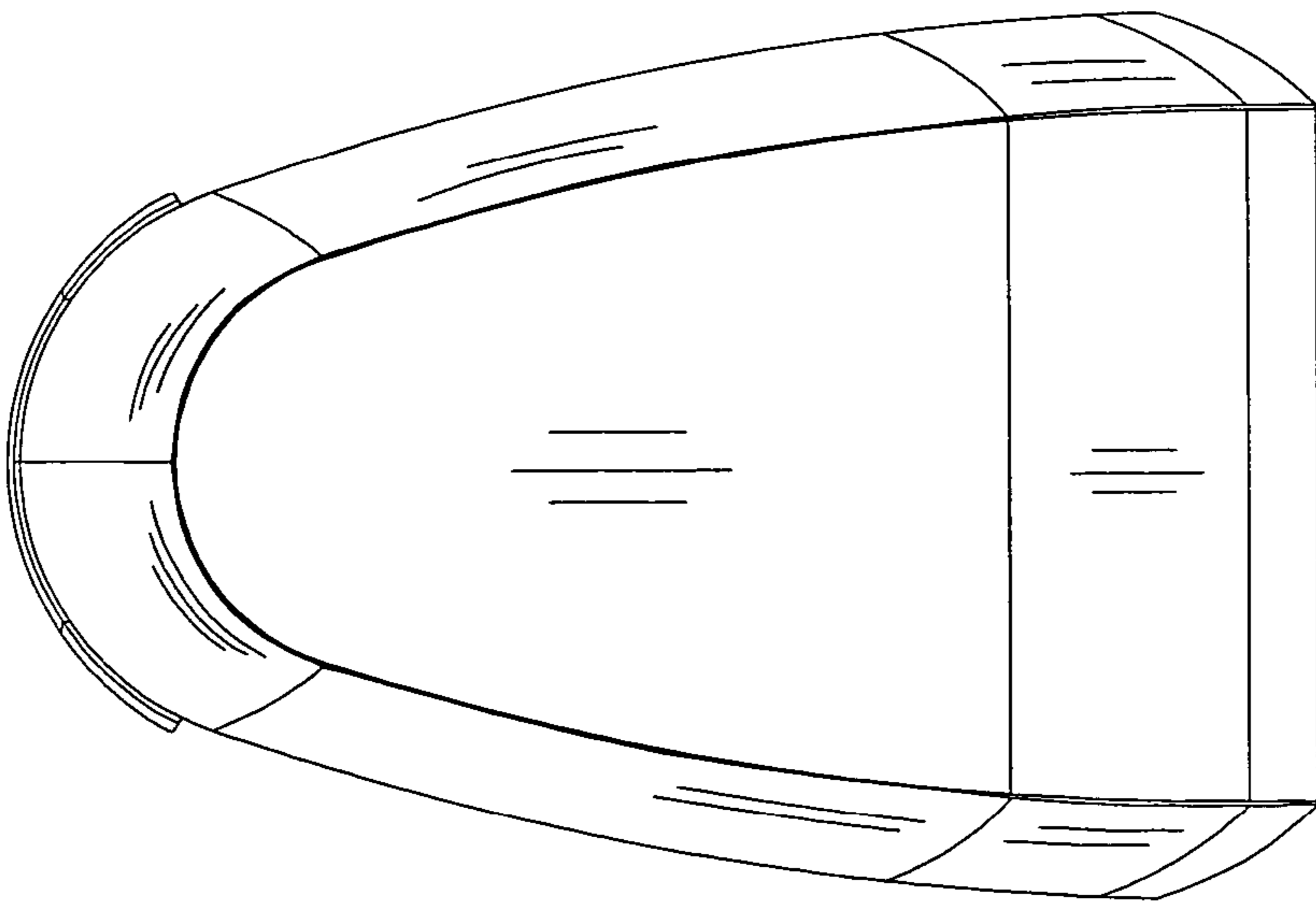

FIG. 5