



US00D579938S

(12) **United States Design Patent**
Romanoff et al.

(10) **Patent No.:** **US D579,938 S**

(45) **Date of Patent:** **** Nov. 4, 2008**

(54) **SHEET SCANNER**

(75) Inventors: **Harris Romanoff**, Narberth, PA (US);
Peter Michaelian, New York, NY (US)

(73) Assignee: **Digital Business Processes, Inc.**,
Philadelphia, PA (US)

(**) Term: **14 Years**

(21) Appl. No.: **29/284,695**

(22) Filed: **Sep. 13, 2007**

(51) **LOC (8) Cl.** **14-02**

(52) **U.S. Cl.** **D14/422**

(58) **Field of Classification Search** D14/420-425,
D14/462-470, 389, 125, 399; D18/50, 54,
D18/55, 53, 36-39, 14, 18-21, 49, 52, 51,
D18/54.4; 358/400, 401, 448, 474, 486-488,
358/496; 382/312, 317, 321, 315; 400/613,
400/613.1-613.4, 690.1-690.4, 691-694,
400/88, 175; 399/107, 379, 380, 211, 212;
235/462.11, 462.41, 472.01, 470, 462.43;
361/680, 681

See application file for complete search history.

(56) **References Cited**

U.S. PATENT DOCUMENTS

D231,539 S * 4/1974 MacConkey D14/462
D249,797 S * 10/1978 Van Acker et al. D18/36
D286,640 S * 11/1986 Miyazaki D18/54
D290,959 S * 7/1987 Ooie D14/462
D295,416 S * 4/1988 Glaberson D14/422
D301,141 S * 5/1989 Sugimoto D18/54
D315,172 S * 3/1991 Lampe D18/54
D330,721 S * 11/1992 Yoshihara D18/50
D331,753 S * 12/1992 Itou et al. D14/462
5,182,697 A * 1/1993 I-Shou 361/683
D339,372 S * 9/1993 Kando D18/50
D339,576 S * 9/1993 Sawada et al. D14/462
D343,381 S * 1/1994 Inukai et al. D13/107
D343,409 S * 1/1994 Kobayashi D18/50
D344,078 S * 2/1994 Inukai et al. D14/462
D344,079 S * 2/1994 Inukai et al. D14/462

D345,353 S * 3/1994 Dietrich D14/462
D350,343 S * 9/1994 Saito et al. D14/422
D352,056 S * 11/1994 Kawashima et al. D18/50
D358,826 S * 5/1995 Kuhns D15/146
D360,429 S * 7/1995 Kawashima et al. D18/55
D361,084 S * 8/1995 Yamanaka et al. D18/50
D368,468 S * 4/1996 Kobayashi D14/388
D370,008 S * 5/1996 Cheng D14/422
5,531,431 A * 7/1996 Saito et al. 271/4.01

(Continued)

Primary Examiner—Melanie Tung

Assistant Examiner—Susan Moon Lee

(74) *Attorney, Agent, or Firm*—Woodcock Washburn LLP

(57) **CLAIM**

The ornamental design for a sheet scanner, as shown and described.

DESCRIPTION

FIG. 1 is a perspective view of a first embodiment of a sheet scanner in accordance with our design;

FIG. 2 is a front elevational view thereof;

FIG. 3 is a rear elevational view thereof;

FIG. 4 is a top plan view thereof;

FIG. 5 is a bottom plan view thereof;

FIG. 6 is a left-side elevational view thereof;

FIG. 7 is a right-side elevational view thereof;

FIG. 8 is a perspective view of a second embodiment of a sheet scanner in accordance with our new design;

FIG. 9 is a front elevational view thereof;

FIG. 10 is a rear elevational view thereof;

FIG. 11 is a top plan view thereof;

FIG. 12 is a bottom plan view thereof;

FIG. 13 is a left-side elevational view thereof; and,

FIG. 14 is a right-side elevational view thereof.

The portions shown in broken line are not claimed.

1 Claim, 8 Drawing Sheets

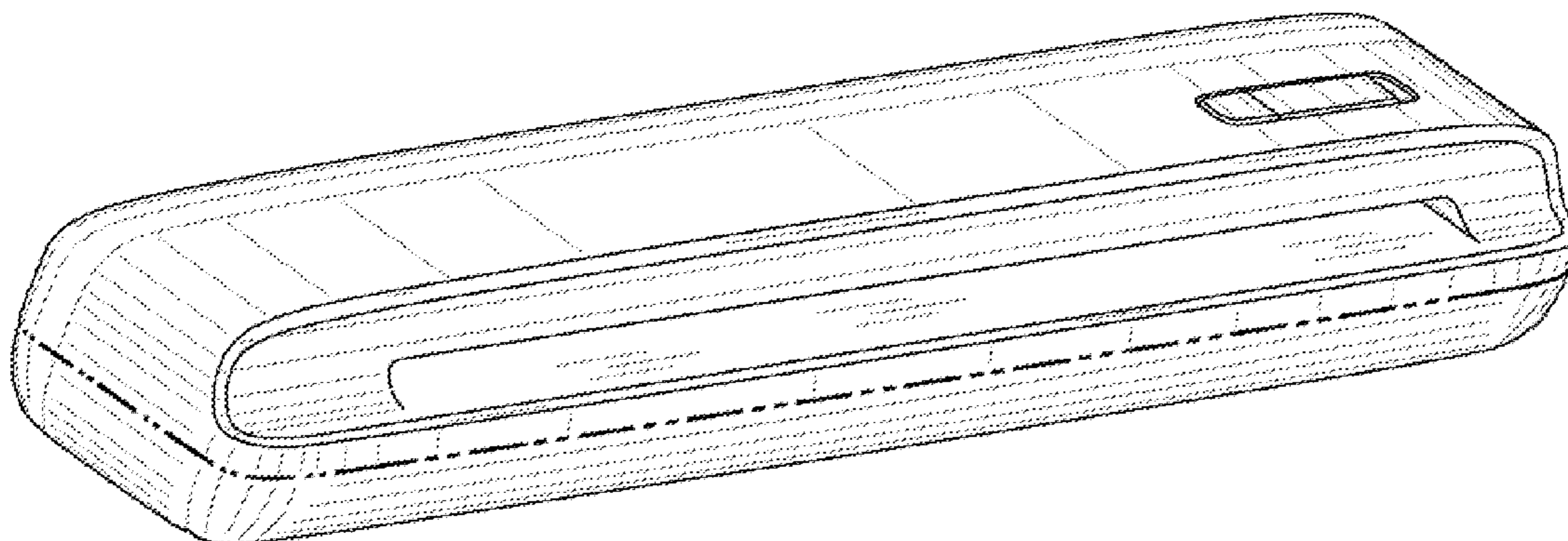

US D579,938 S

Page 2

U.S. PATENT DOCUMENTS

D374,888 S *	10/1996	Udagawa	D18/50	D415,128 S *	10/1999	Kitera	D14/422
5,825,505 A *	10/1998	Toyoda et al.	358/400	D435,849 S *	1/2001	Tasi	D14/422
D407,712 S *	4/1999	Hasegawa	D14/422	D525,626 S *	7/2006	Fukunaga et al.	D14/462

* cited by examiner

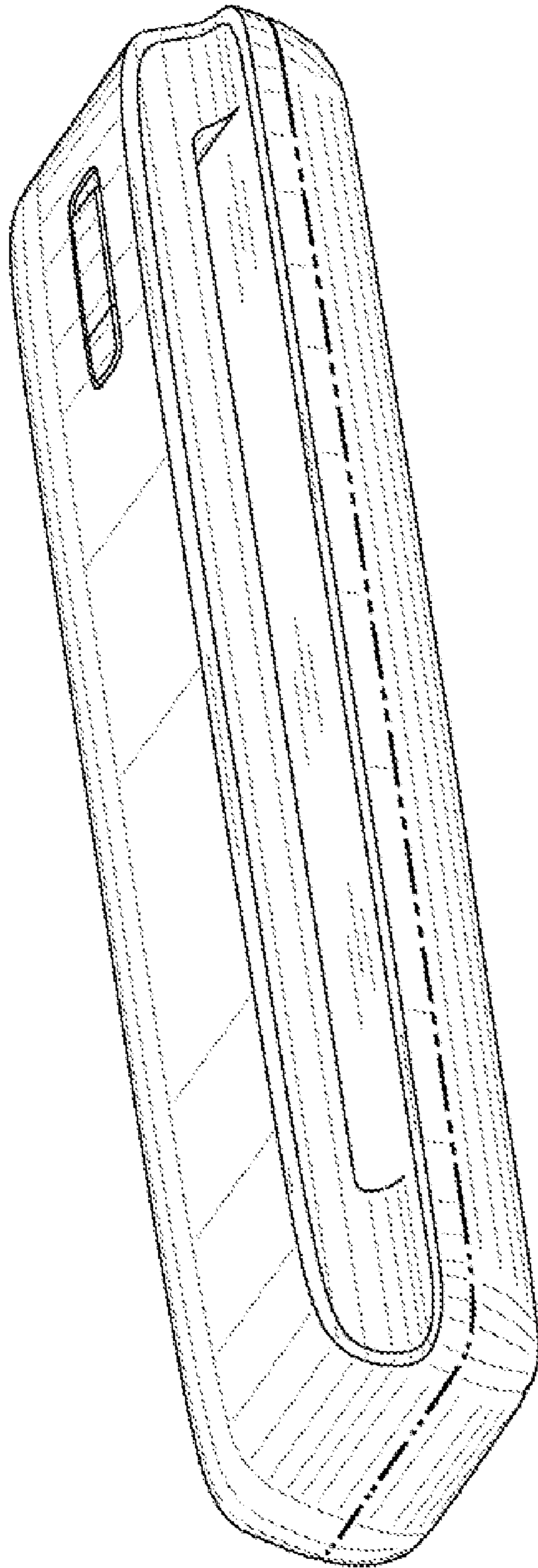

FIG. 1

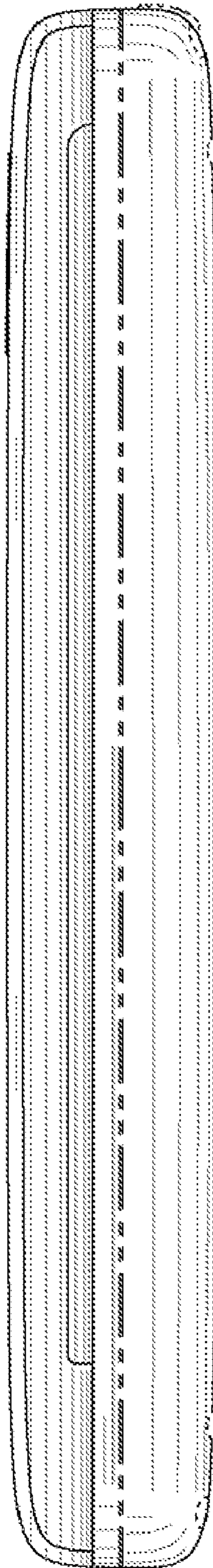

FIG. 2

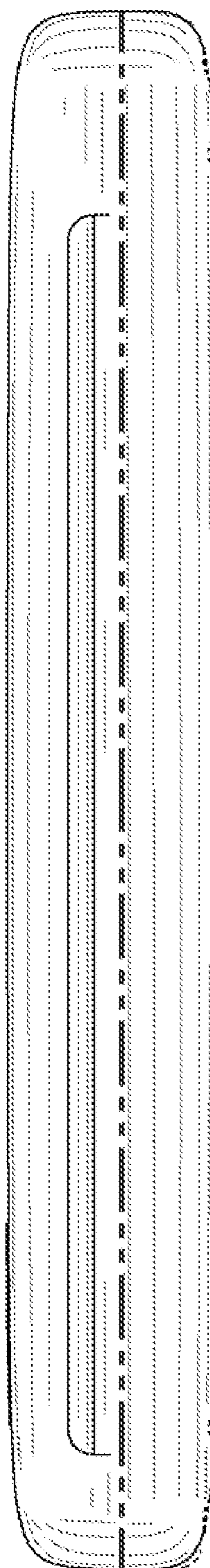

FIG. 3

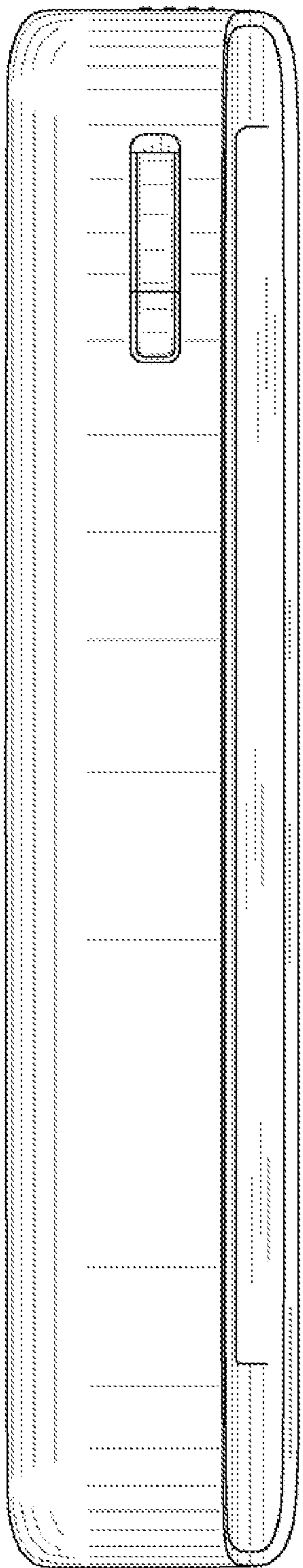

FIG. 4

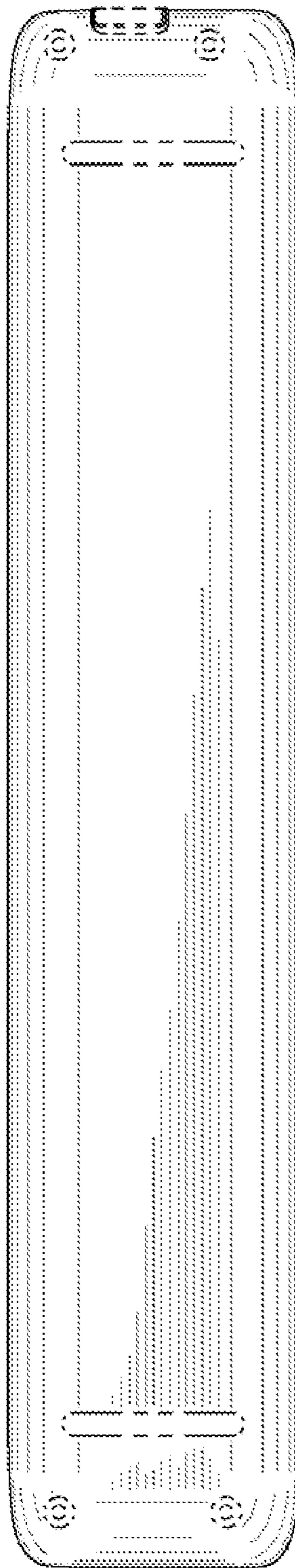

FIG. 5

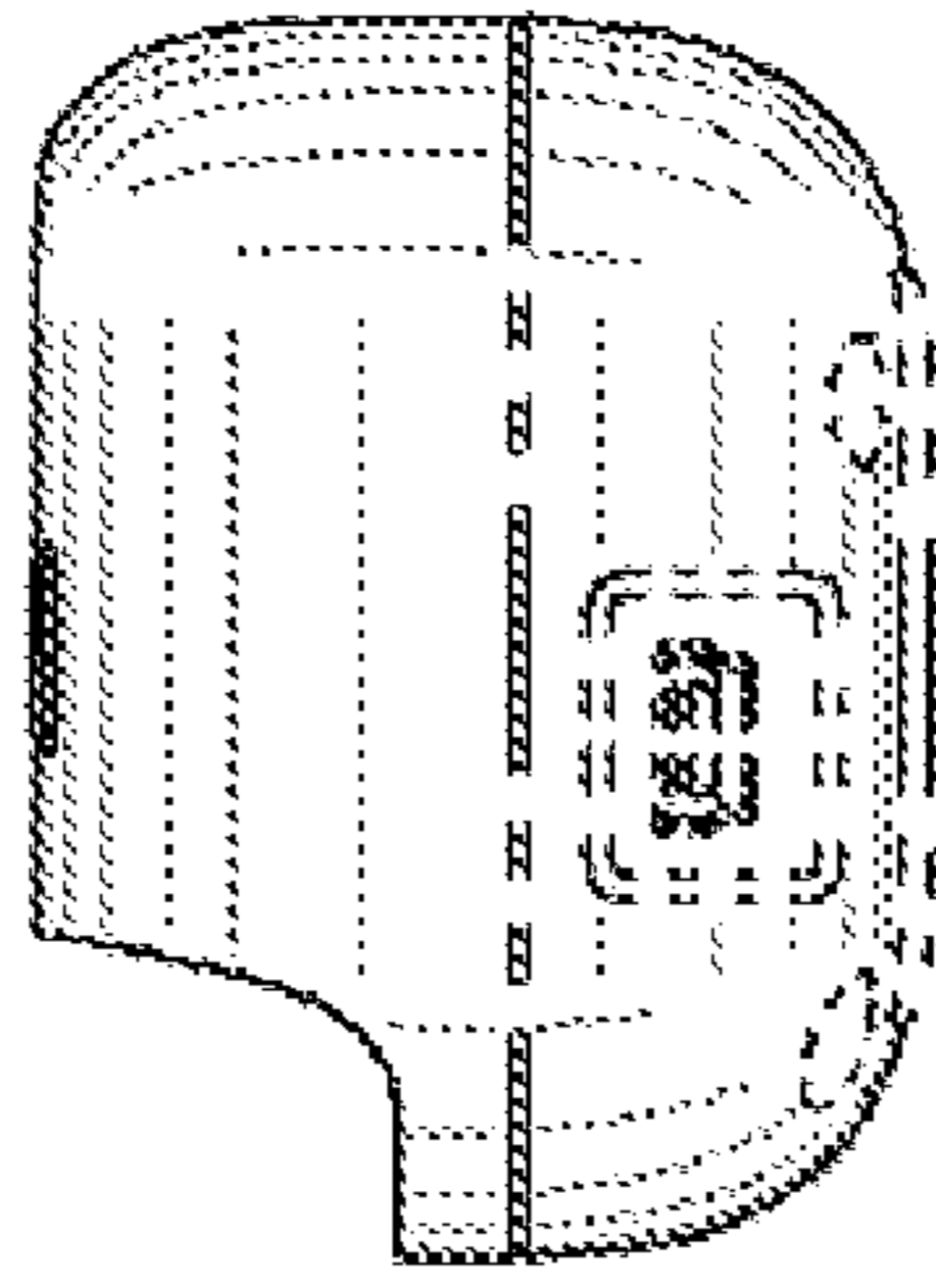

FIG. 7

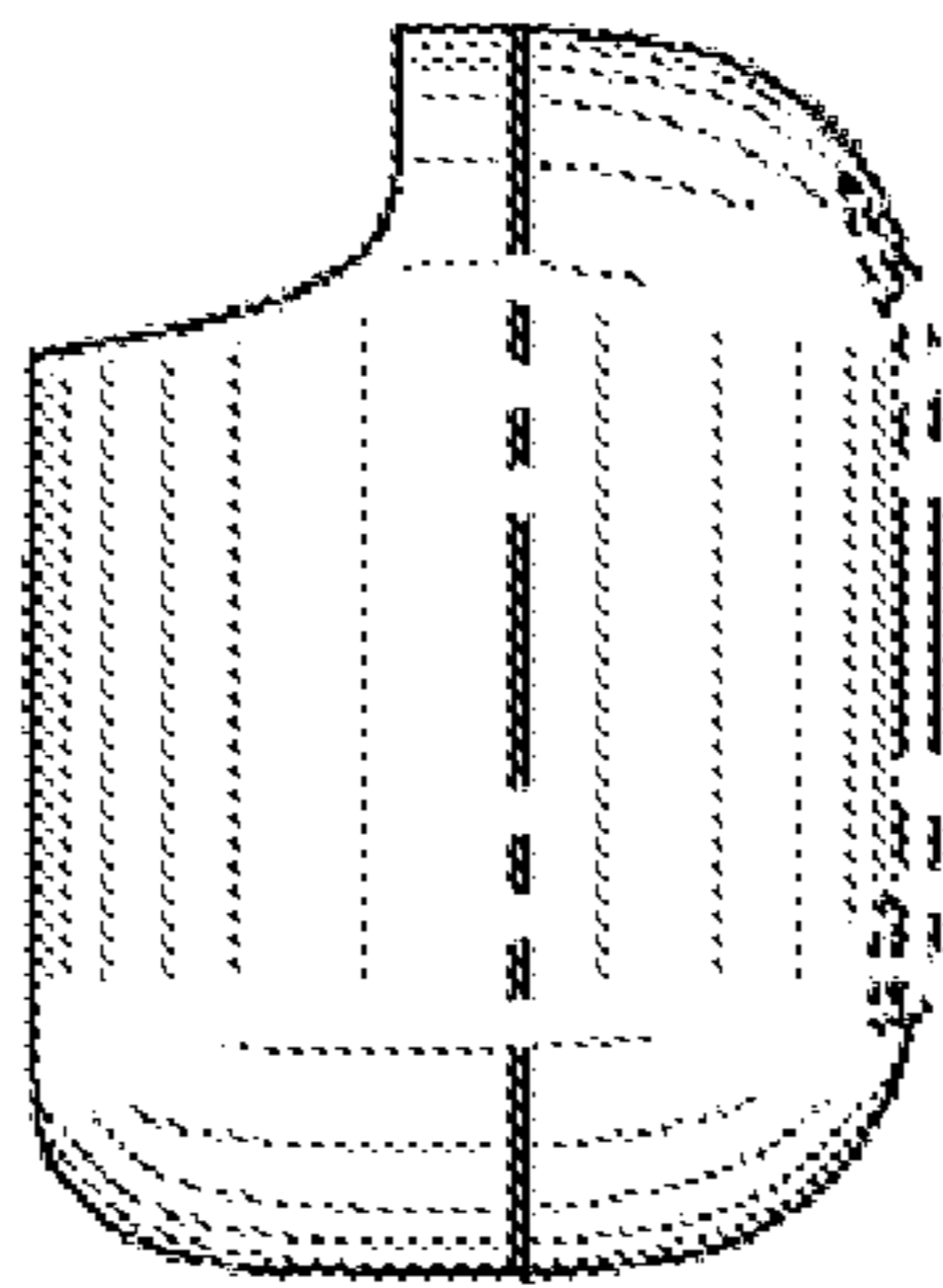

FIG. 6

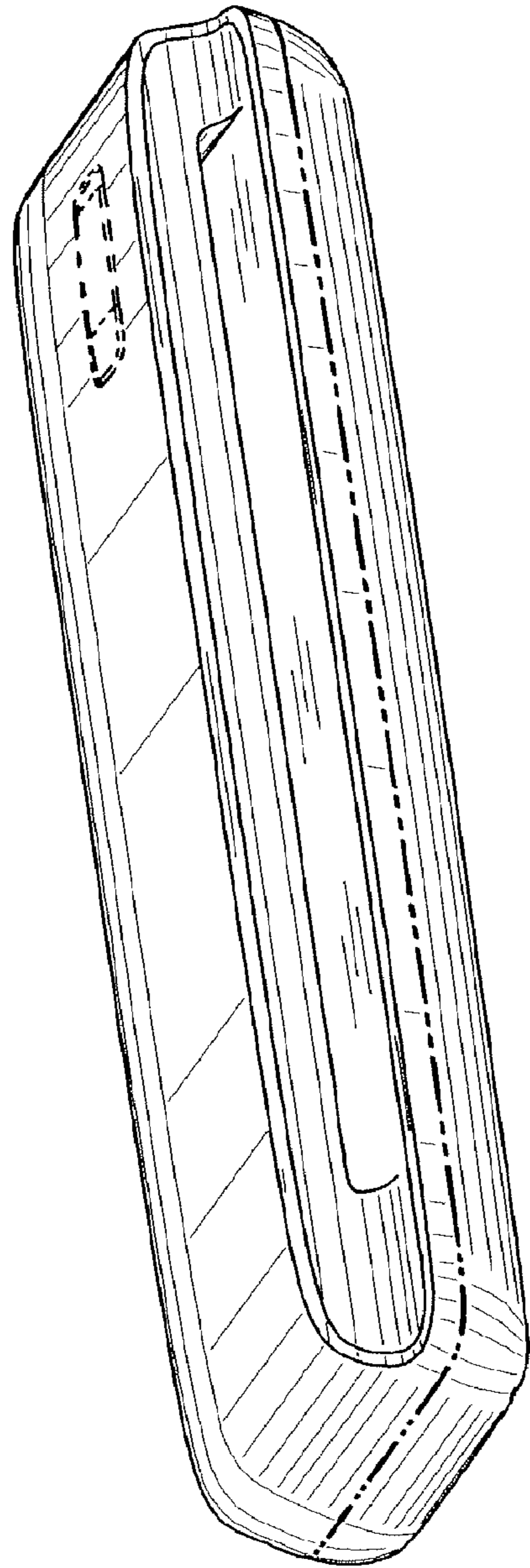

FIG. 8

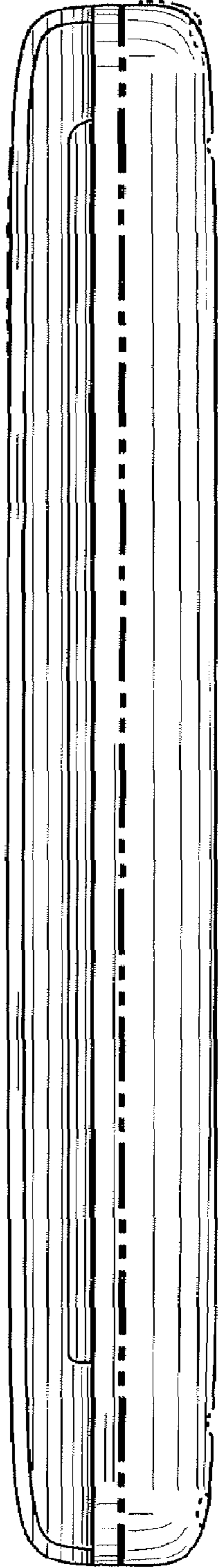

FIG. 9

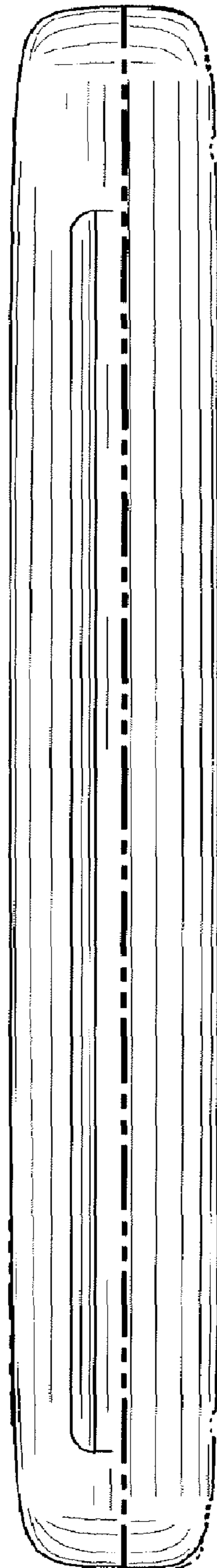

FIG. 10

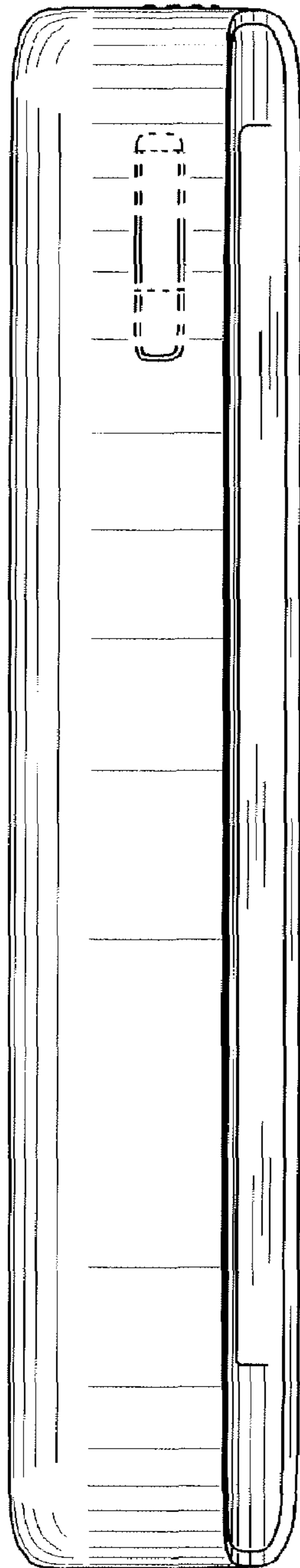

FIG. 11

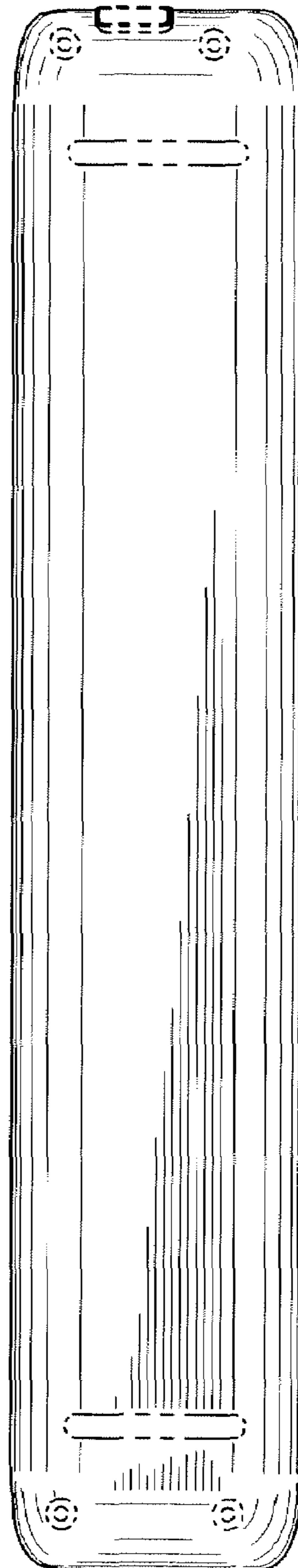

FIG. 12

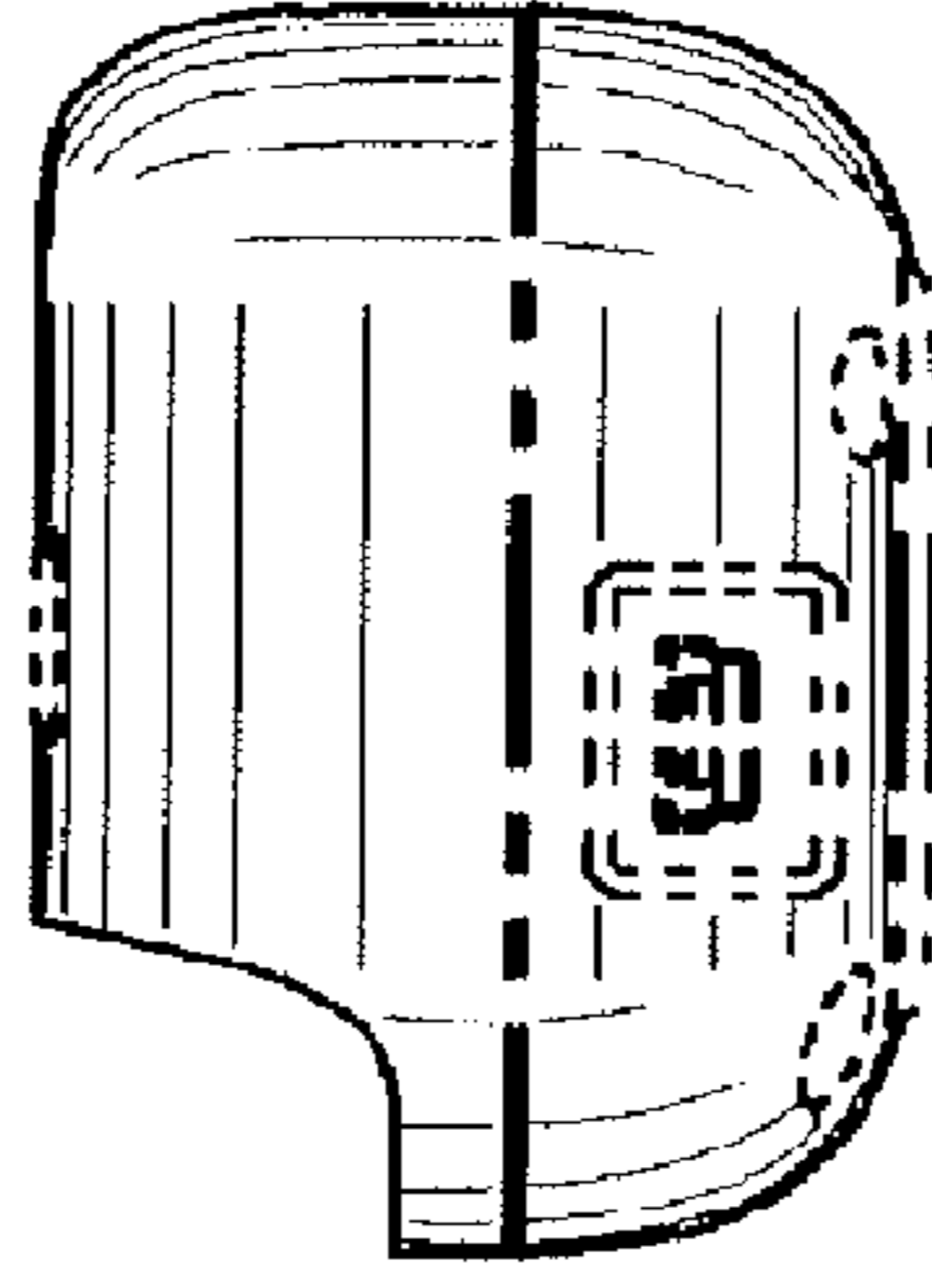

FIG. 14

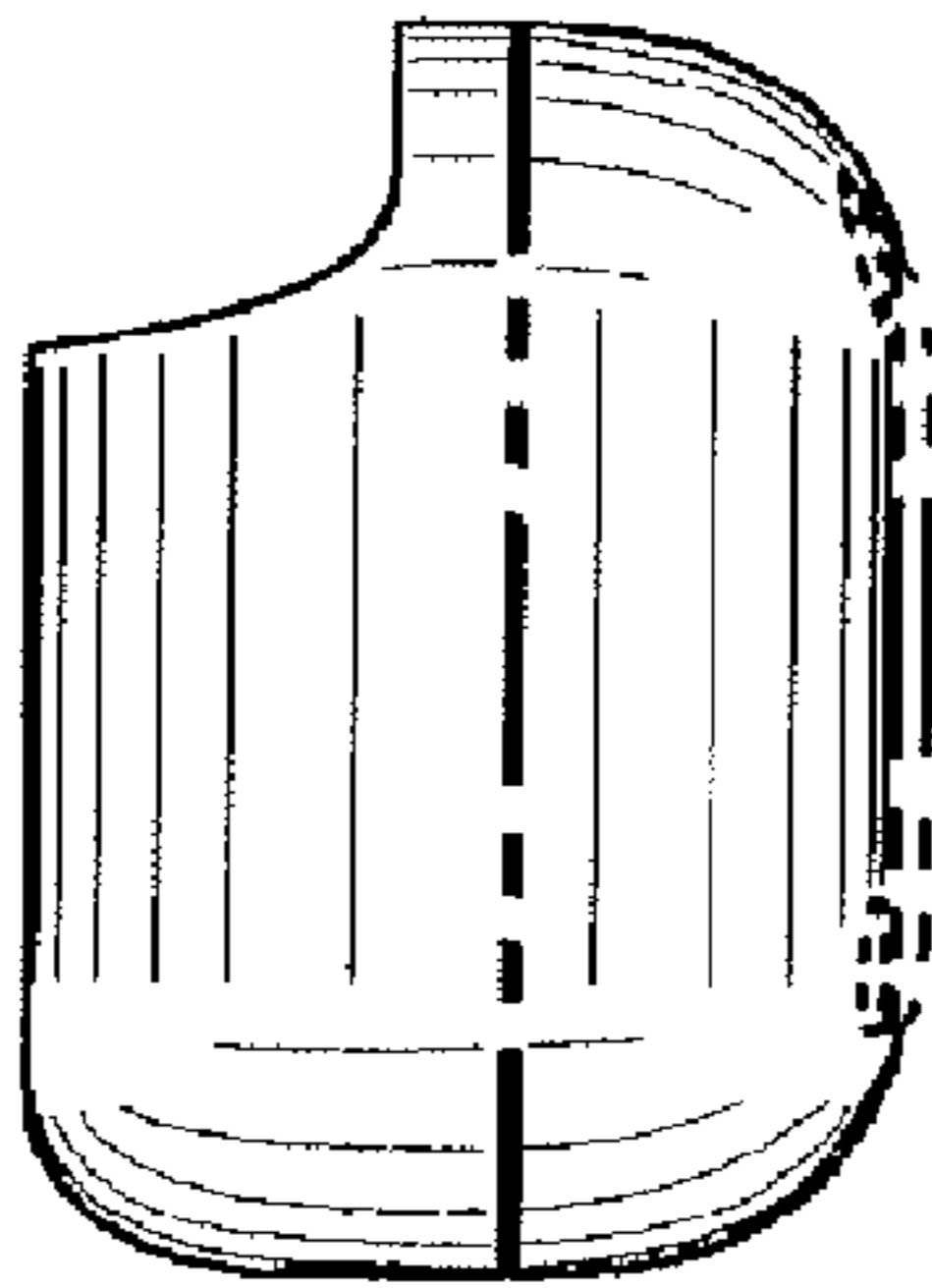

FIG. 13