



US00D579772S

(12) **United States Design Patent**
Williams

(10) **Patent No.:** **US D579,772 S**
(45) **Date of Patent:** **** Nov. 4, 2008**

(54) **CAP**
(75) Inventor: **Michael E. Williams**, San Marcos, CA
(US)
(73) Assignee: **Headwind Ceramic Ltd.**, West (HK)
(**) Term: **14 Years**
(21) Appl. No.: **29/265,003**
(22) Filed: **Aug. 21, 2006**

D398,531 S 9/1998 De Vries
D451,023 S * 11/2001 Kitamura et al. D9/449
D483,611 S 12/2003 Diak Ghanem
D488,348 S 4/2004 Liu
D506,641 S 6/2005 Liu
D508,594 S 8/2005 Snell
D512,917 S 12/2005 Frisch et al.
D523,333 S * 6/2006 Moretti D9/444
D530,203 S * 10/2006 Li D9/449
D531,452 S 11/2006 Toth
D533,061 S * 12/2006 Li D9/443
D535,151 S 1/2007 Seum et al.
D539,660 S * 4/2007 Bunch D9/551

(51) **LOC (8) Cl.** **09-06**
(52) **U.S. Cl.** **D9/446**
(58) **Field of Classification Search** D9/500,
D9/502-504, 516, 519, 529, 535, 537-540,
D9/549-551, 553-554, 557-558, 682, 686,
D9/688-691, 434, 443-447, 449-450, 452-454;
D7/509-511, 612, 629; 215/216, 235, 237,
215/244-245, 273, 277, 280, 282, 287, 289,
215/290, 293-294, 302

See application file for complete search history.

(56) **References Cited**
U.S. PATENT DOCUMENTS

D120,587 S 5/1940 Hinkins
D181,918 S * 1/1958 Arens D9/538
D299,426 S 1/1989 Andersson et al.
D332,373 S * 1/1993 Kahl D7/510
D357,413 S 4/1995 Kornick et al.
D357,414 S 4/1995 Kornick et al.
D383,037 S 9/1997 Asberg

* cited by examiner

Primary Examiner—Ian Simmons
Assistant Examiner—Dana L Sipos
(74) *Attorney, Agent, or Firm*—Holland & Hart

(57) **CLAIM**

The ornamental design for a cap, as shown.

DESCRIPTION

FIG. 1 is a perspective view of a cap, showing my design;
FIG. 2 is a front elevational view thereof;
FIG. 3 is a right side elevational view thereof;
FIG. 4 is a left side elevational view thereof;
FIG. 5 is a rear elevational view thereof; and,
FIG. 6 is a top plan view thereof.

1 Claim, 3 Drawing Sheets

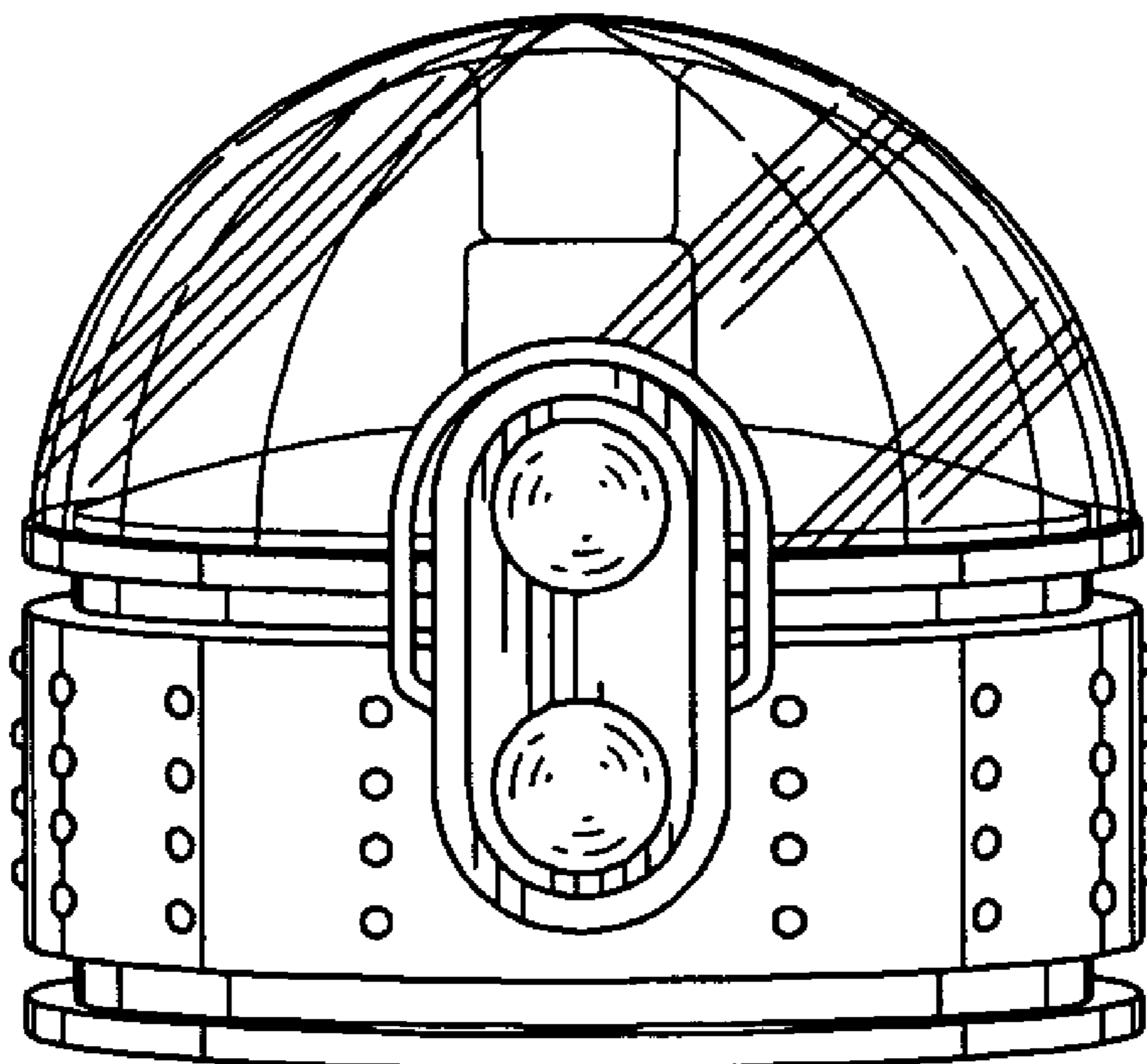

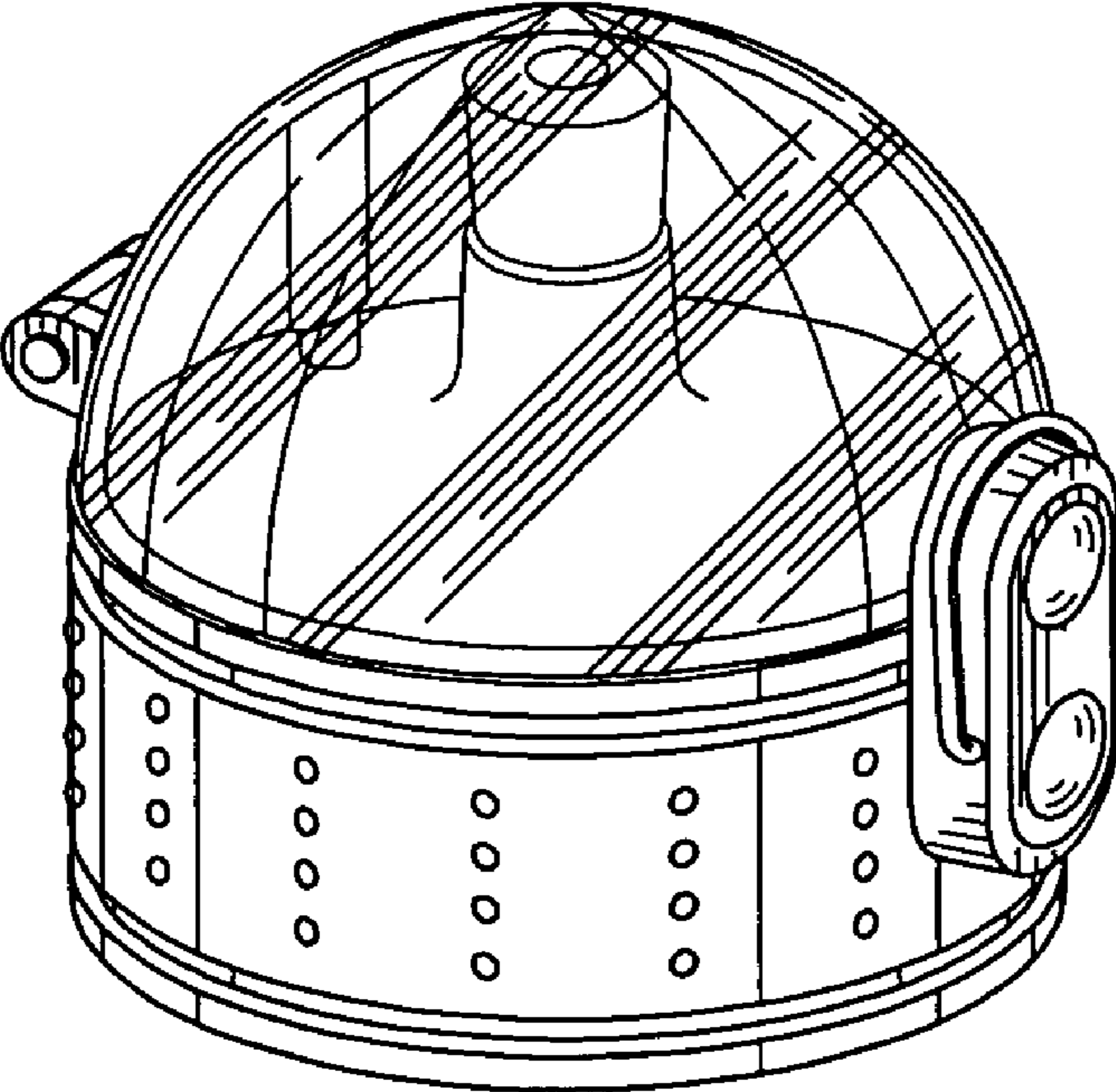

FIG. 1

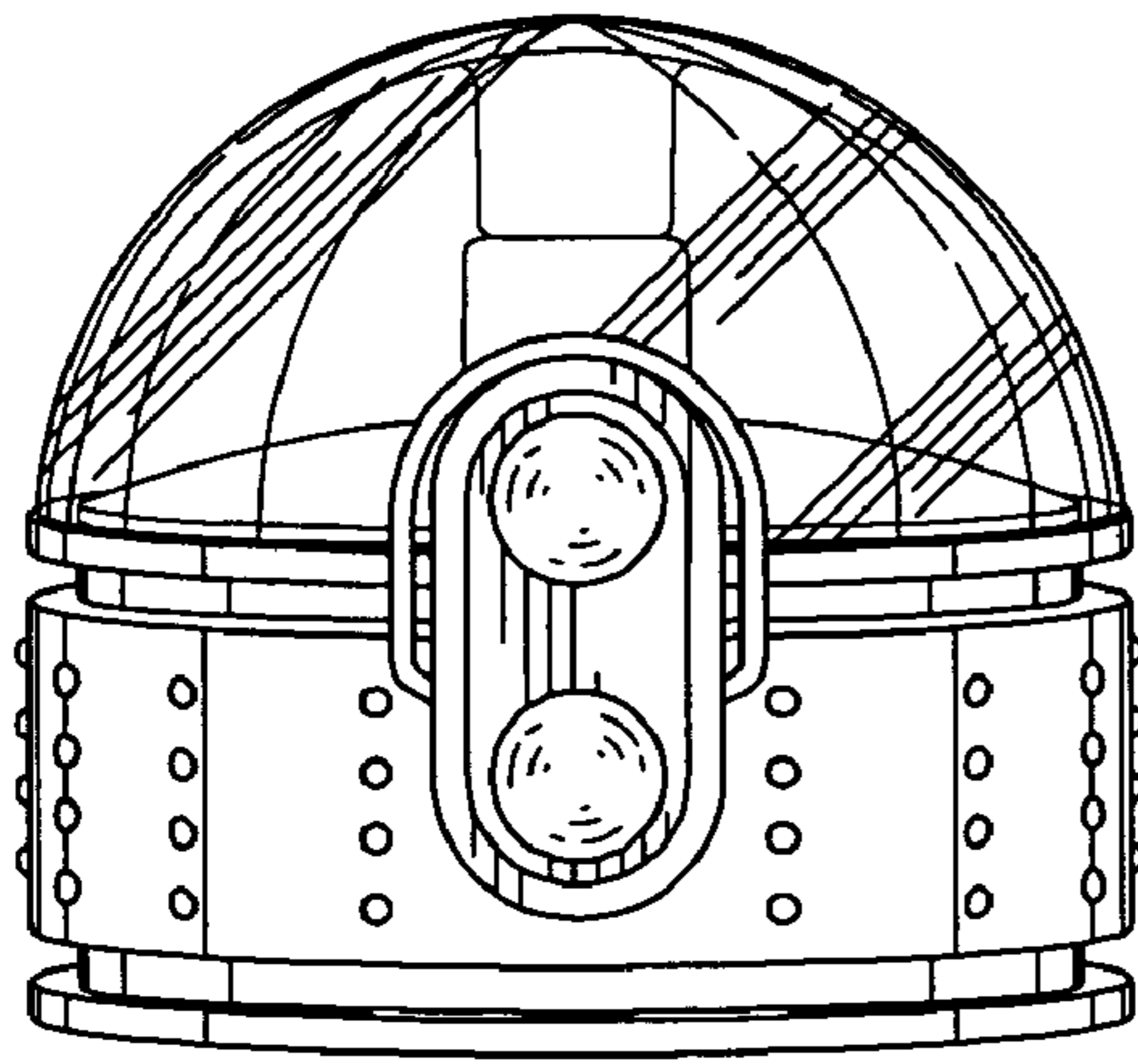

FIG. 2

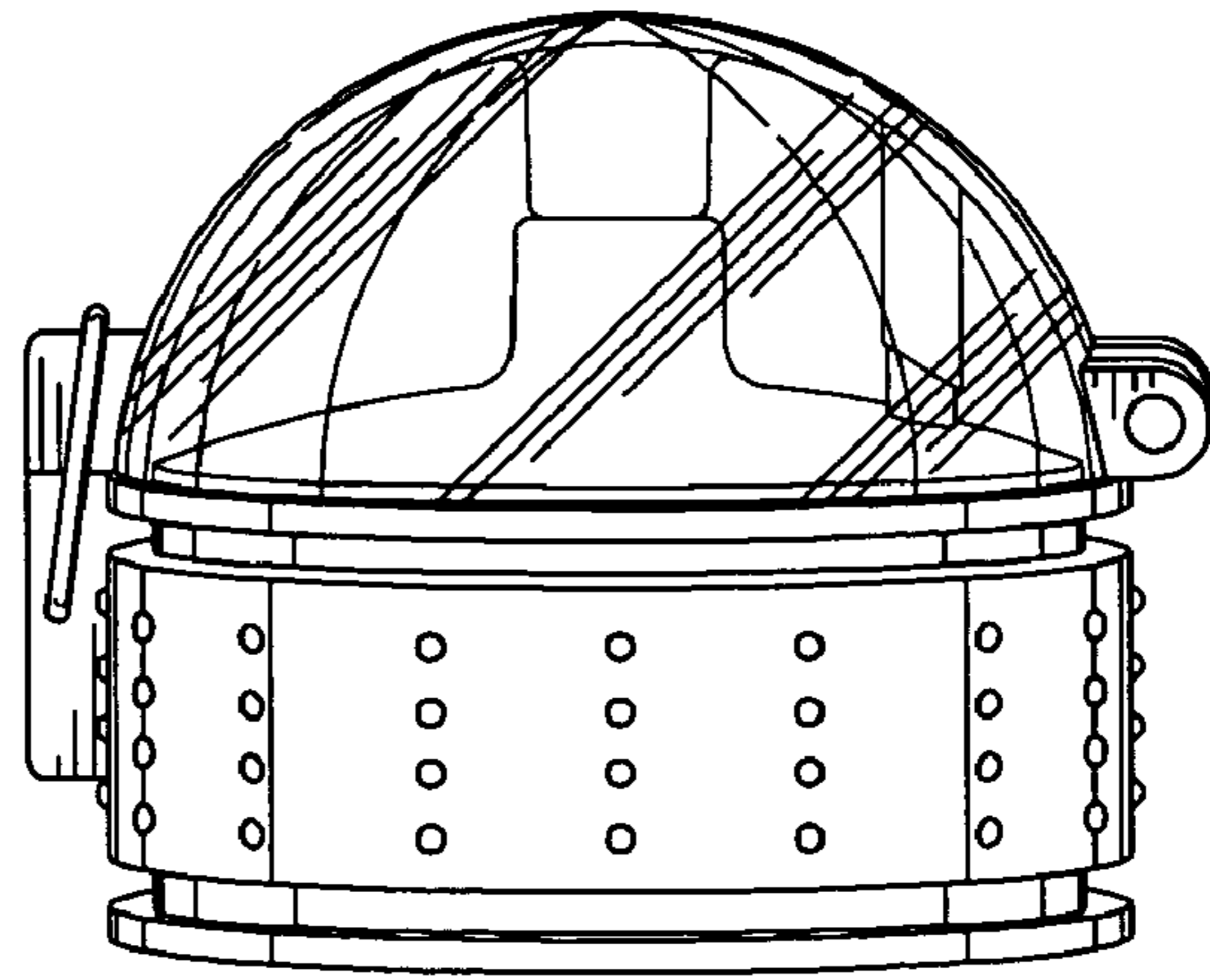

FIG. 3

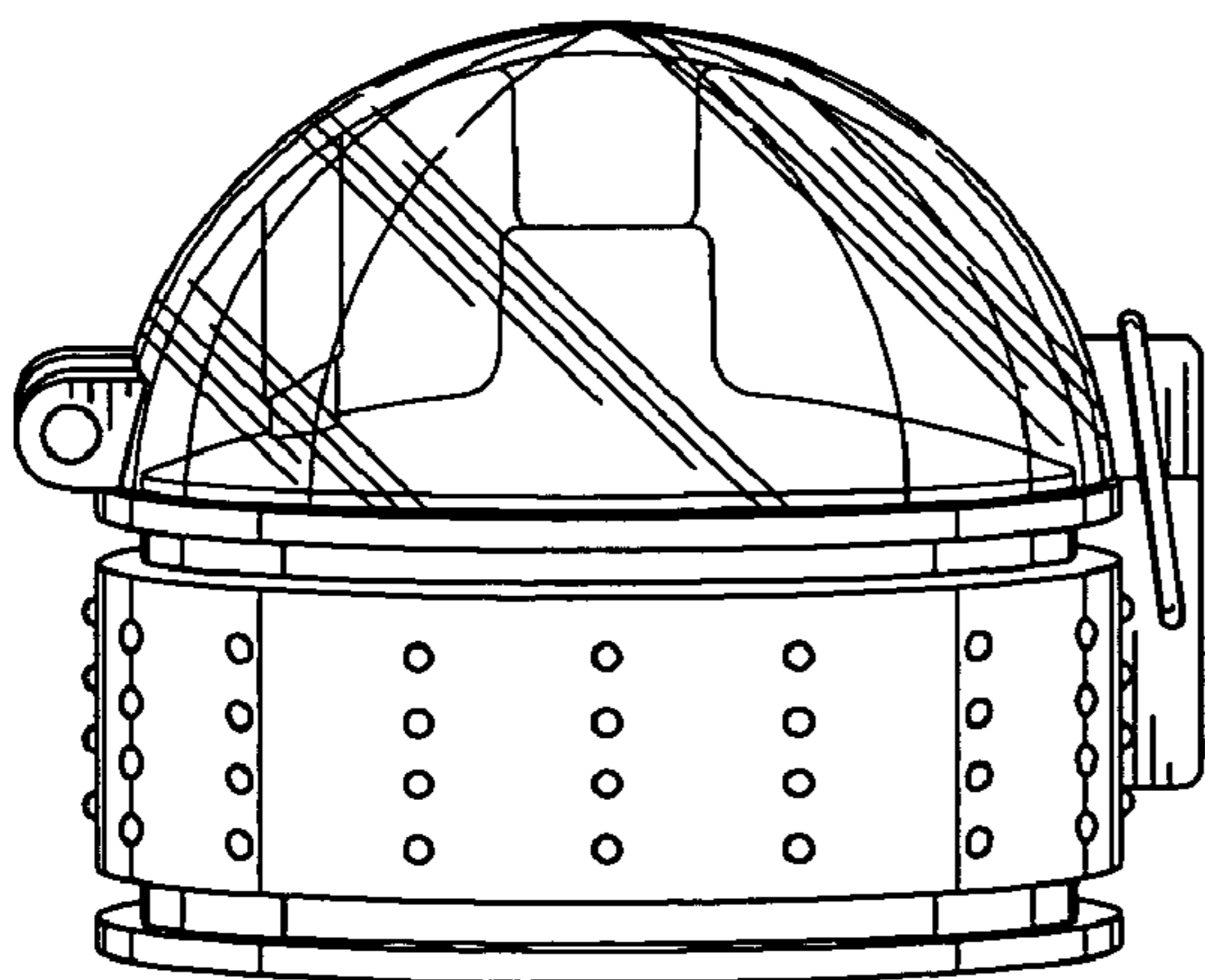

FIG. 4

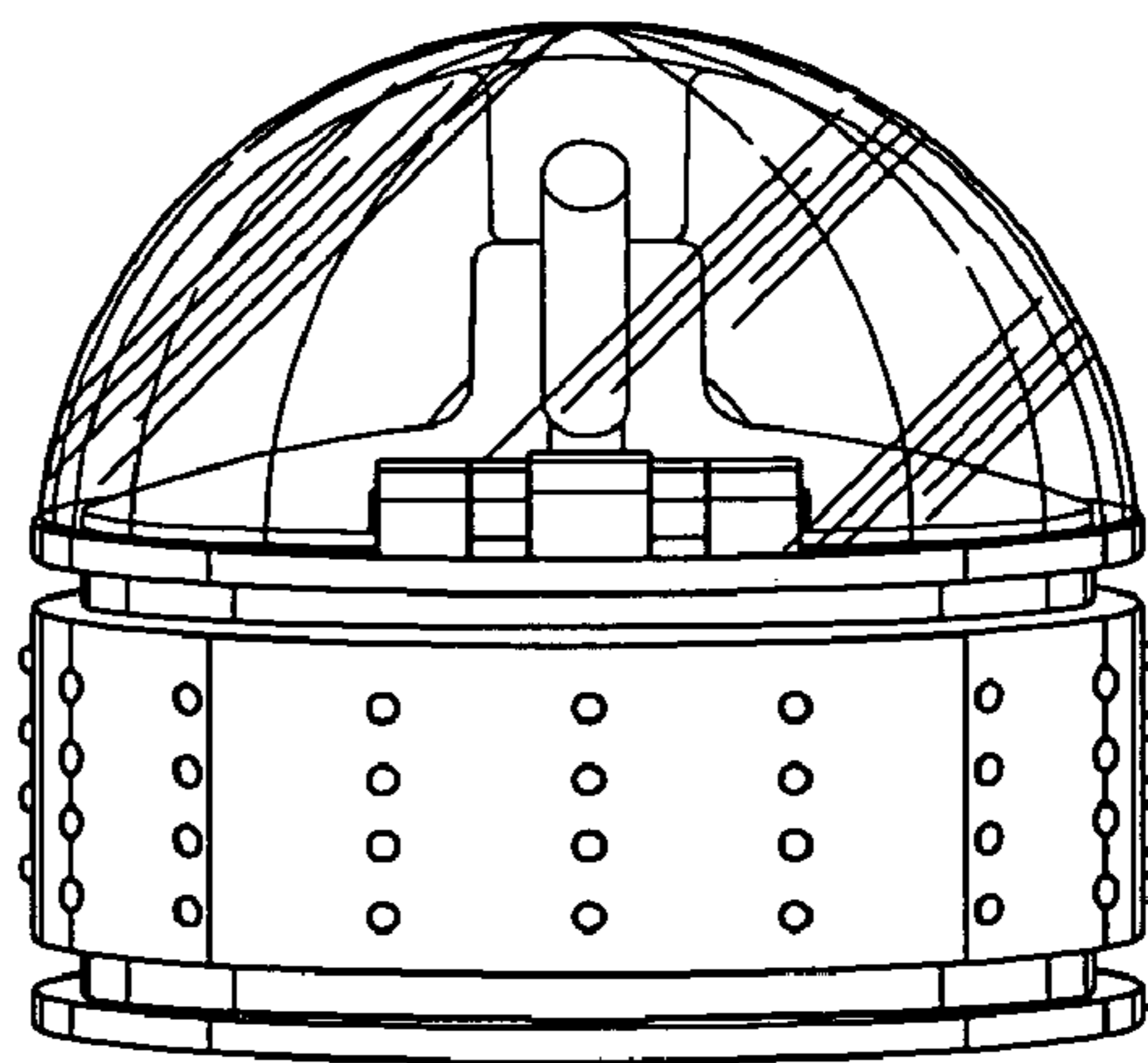

FIG. 5

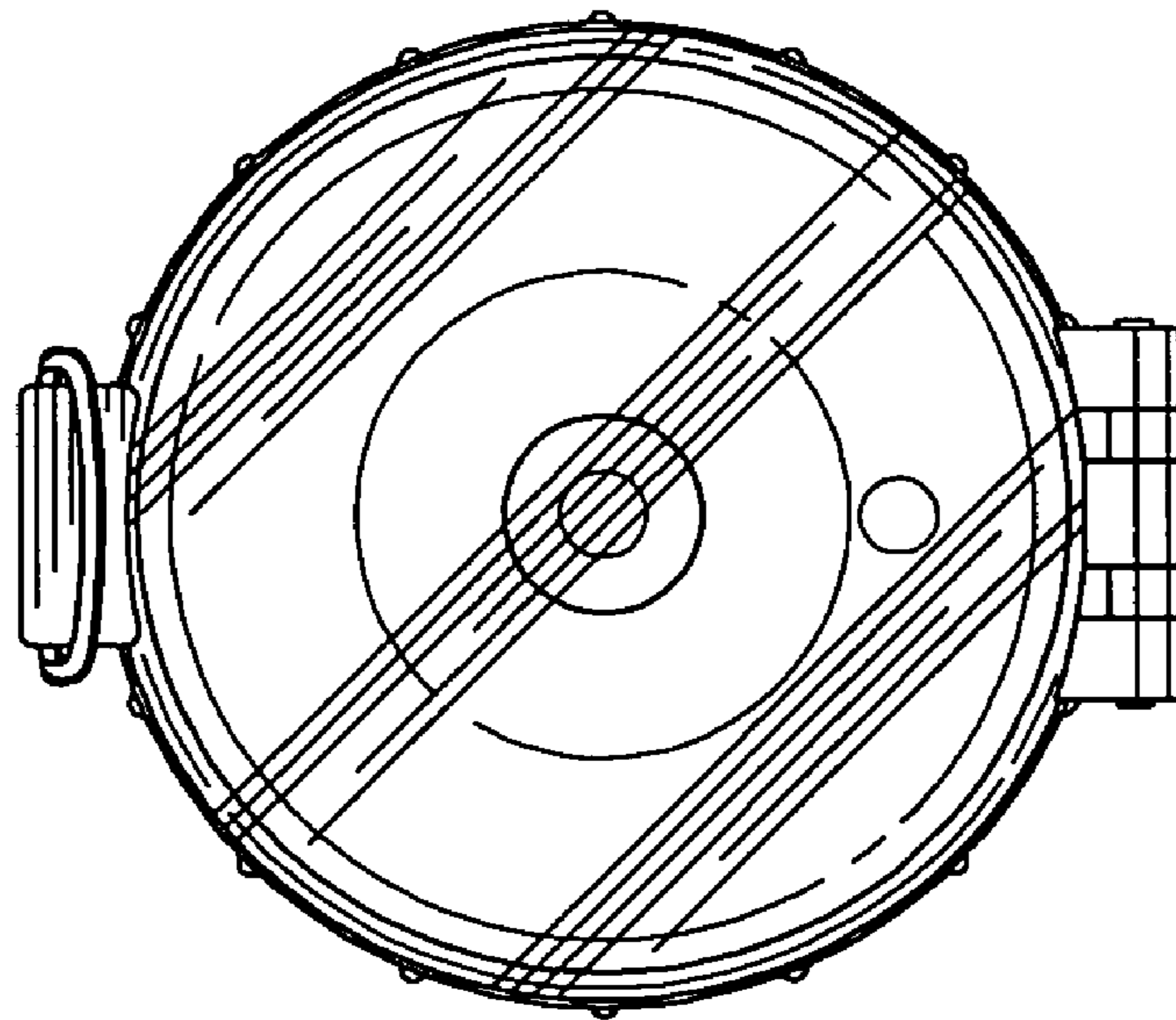

FIG. 6