



US00D579732S

(12) **United States Design Patent**  
**deBretton Gordon**

(10) **Patent No.:** **US D579,732 S**  
(45) **Date of Patent:** **\*\* Nov. 4, 2008**

(54) **KNIFE**

(75) Inventor: **Kit Han deBretton Gordon,**  
Shipston-on-Stour (GB)

(73) Assignee: **Robert Welch Designs Limited,**  
Chipping Campden, Gloucestershire  
(GB)

(\*\*) Term: **14 Years**

(21) Appl. No.: **29/304,647**

(22) Filed: **Mar. 5, 2008**

(30) **Foreign Application Priority Data**

Sep. 7, 2007 (EM) ..... 000788419

(51) **LOC (8) Cl.** ..... **07-03**

(52) **U.S. Cl.** ..... **D7/649**

(58) **Field of Classification Search** ..... D7/368,  
D7/393, 395, 401.2, 642-653, 660-664, 669,  
D7/675-676, 683, 688, 692-696; D8/10,  
D8/36, 75, 80, 83, 87, 98, 99, 102, 107, 300,  
D8/303; 30/123.5-123.7, 124-125, 128,  
30/137, 141-143, 147-150, 169, 304, 316,  
30/322-329, 342-346, 353, 355, 394; 416/70 R  
See application file for complete search history.

(56) **References Cited**

**U.S. PATENT DOCUMENTS**

D177,740 S \* 5/1956 Latham ..... D7/652

D189,913 S \* 3/1961 Quistgaard ..... D7/649  
D202,892 S \* 11/1965 Centa ..... D7/649  
D470,021 S \* 2/2003 Jalet ..... D7/649  
D483,991 S \* 12/2003 Poupel ..... D7/401.2  
D491,026 S \* 6/2004 Welch ..... D7/652  
D492,163 S \* 6/2004 Welch ..... D7/652  
D544,763 S \* 6/2007 Hine ..... D7/642

\* cited by examiner

*Primary Examiner*—Caron D. Veynar

*Assistant Examiner*—Ricky Pham

(74) *Attorney, Agent, or Firm*—MacMillan, Sobanski &  
Todd, LLC

(57) **CLAIM**

The ornamental design for a knife, as shown and described.

**DESCRIPTION**

FIG. 1 is a perspective view as seen from the upper left side of  
a knife showing my new design;

FIG. 2 is a top view thereof;

FIG. 3 is a left side view thereof, the right side view being a  
mirror image thereof;

FIG. 4 is a bottom view thereof;

FIG. 5 is a blade end view thereof; and,

FIG. 6 is a handle end view thereof.

**1 Claim, 5 Drawing Sheets**

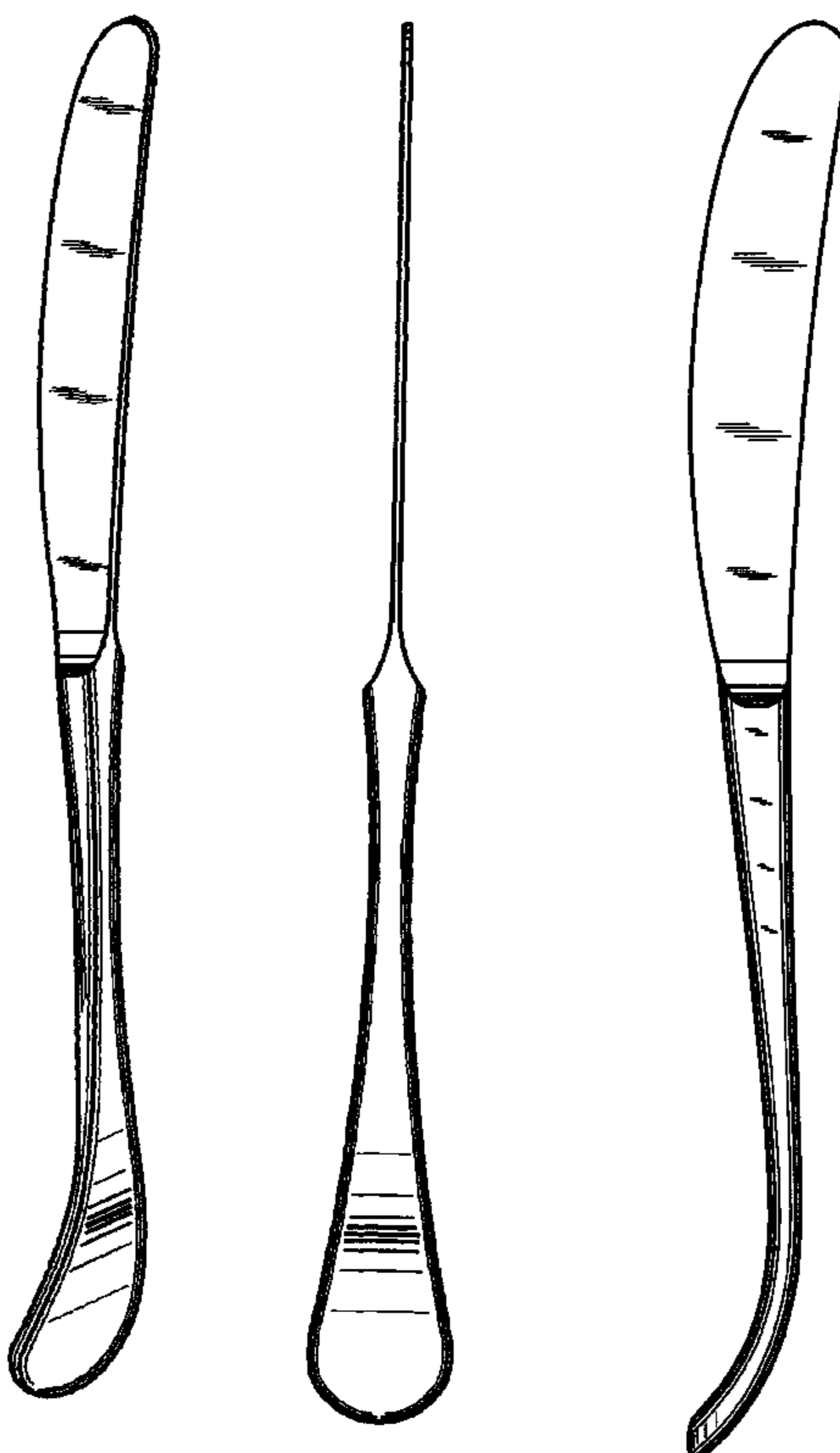

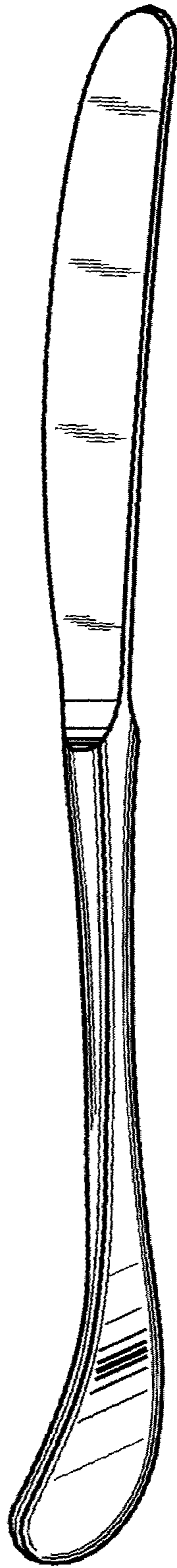

— FIG. 1

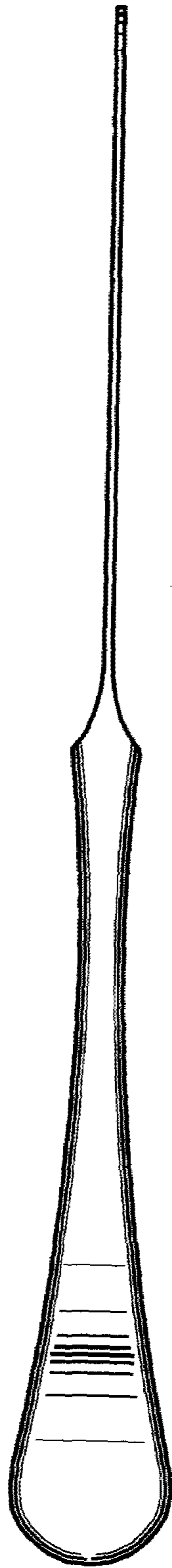

—FIG. 2

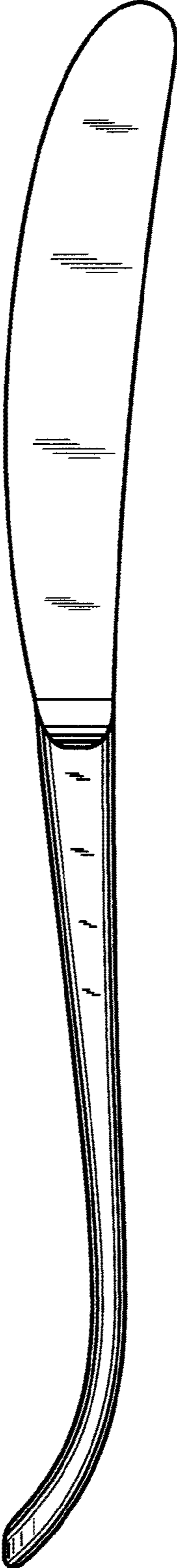

— FIG. 3

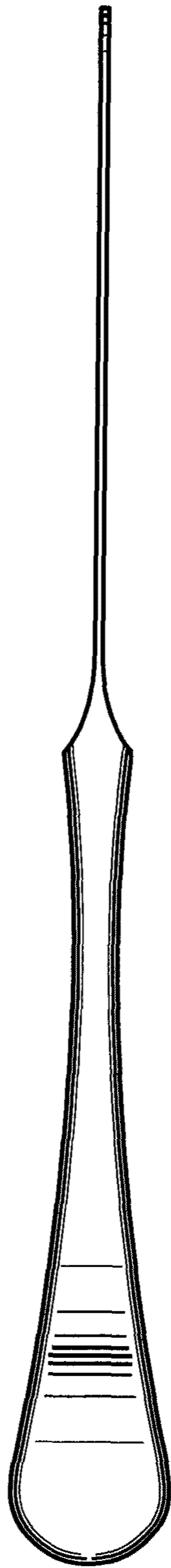

— FIG. 4

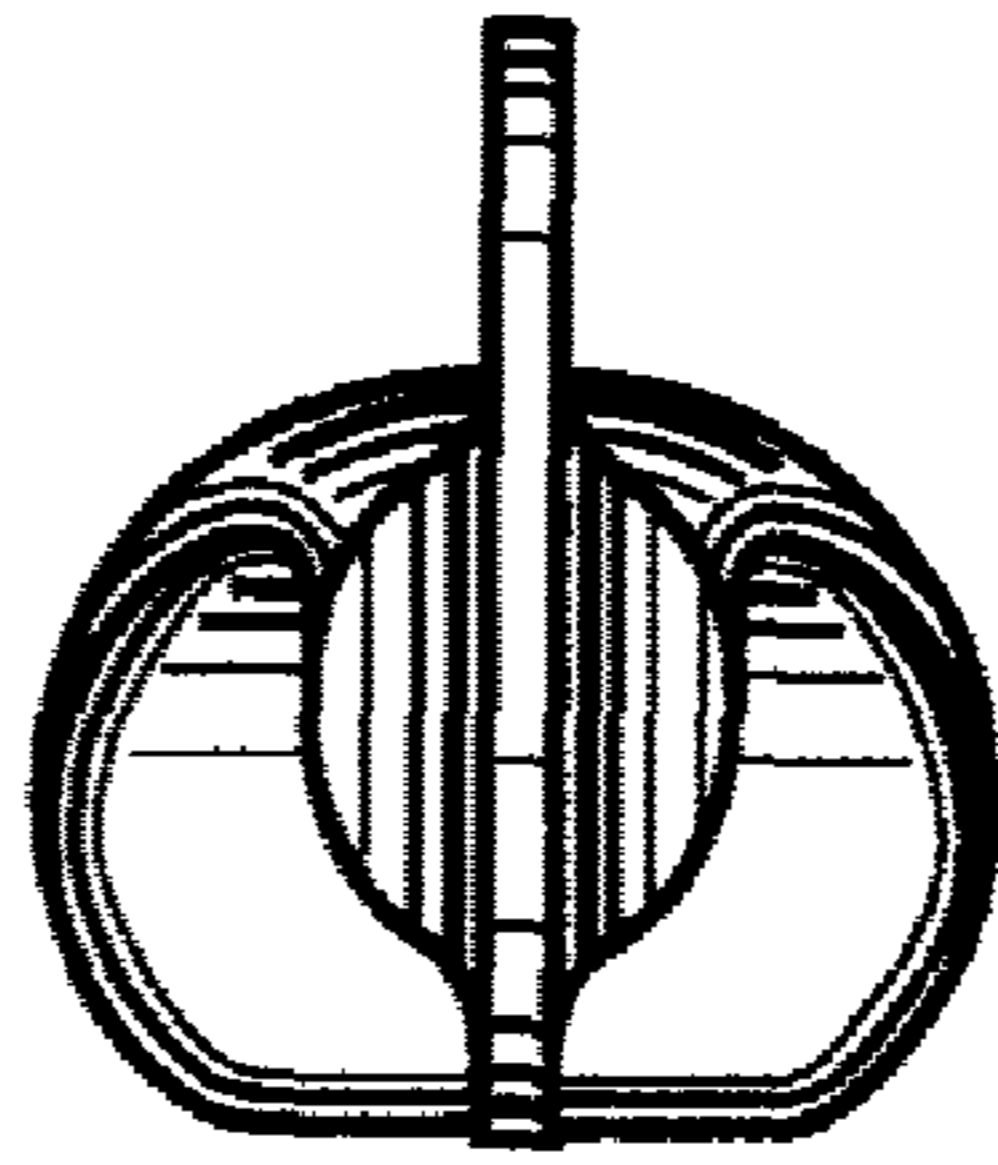

— FIG. 5

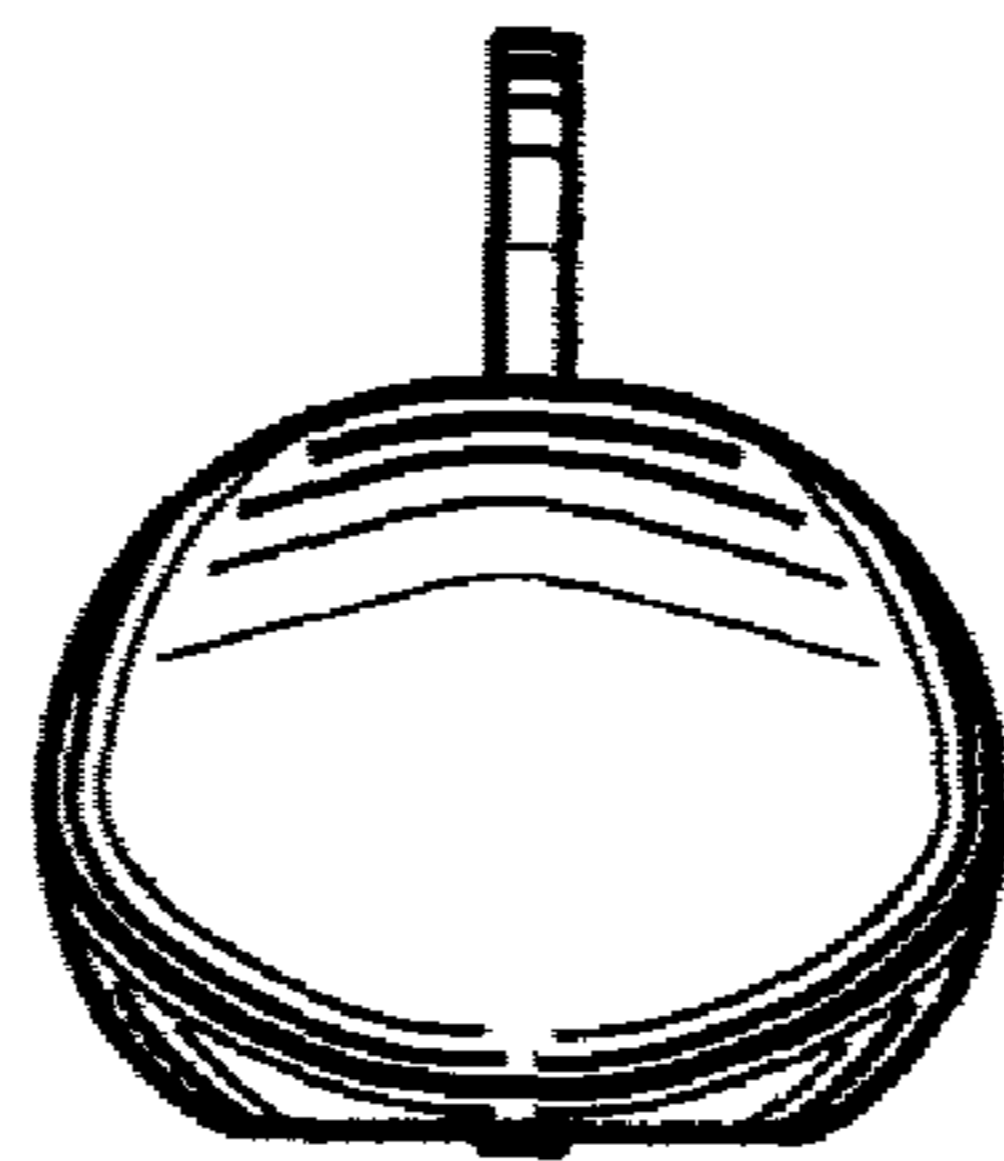

— FIG. 6