



US00D579726S

(12) **United States Design Patent**
Eisenberg

(10) **Patent No.:** **US D579,726 S**

(45) **Date of Patent:** **** Nov. 4, 2008**

(54) **CONTAINER**

(75) Inventor: **Regina Eisenberg**, Cleveland, OH (US)

(73) Assignee: **Maxel Industries LLC**, Pepper Pike, OH (US)

(**) Term: **14 Years**

(21) Appl. No.: **29/299,541**

(22) Filed: **Dec. 28, 2007**

6,450,355 B1 *	9/2002	Lowry	220/4.26
D506,359 S *	6/2005	Zettle et al.	D7/629
6,991,121 B1	1/2006	Kipperman et al.		
D516,915 S *	3/2006	Gaines	D9/552
7,036,975 B2	5/2006	Renz		
D530,218 S *	10/2006	Burkemper	D7/615
D530,572 S *	10/2006	Daams	D7/615

* cited by examiner

Primary Examiner—Terry A Wallace

(74) *Attorney, Agent, or Firm*—Benesch, Friedlander, Coplan & Aronoff LLP

Related U.S. Application Data

(63) Continuation of application No. 11/852,783, filed on Sep. 10, 2007.

(51) **LOC (8) Cl.** **07-01**

(52) **U.S. Cl.** **D7/614**

(58) **Field of Classification Search** D7/612–615, D7/601, 629; D10/46.3; 220/4.01, 4.26, 220/4.27; 73/726–729; 215/365; D9/500–508, D9/547, 551, 552, 559, 572–575; 206/505, 206/508, 509, 515, 519, 520

See application file for complete search history.

(56) **References Cited**

U.S. PATENT DOCUMENTS

3,578,467 A *	5/1971	Huber	220/580
D276,400 S	11/1984	Daenen et al.		
4,583,661 A *	4/1986	Clover, Jr.	222/142.9
D293,608 S *	1/1988	Fitzgerald et al.	D7/615
D310,463 S *	9/1990	Laib	D7/614
D369,755 S	5/1996	Burcham et al.		
5,542,206 A *	8/1996	Lisch	220/4.27
5,570,816 A	11/1996	LaBarbera, Jr.		
5,671,856 A *	9/1997	Lisch	220/4.27
5,682,931 A	11/1997	Mouchmouchian		
D387,171 S	12/1997	Johnson		
D401,115 S *	11/1998	Huang	D7/589
5,887,740 A *	3/1999	Hong	220/4.27
5,947,336 A	9/1999	Thompson		

(57) **CLAIM**

The ornamental design for a container, as shown and described.

DESCRIPTION

FIG. 1 is a top perspective view of a container showing the new design;

FIGS. 2–8 are top perspective views of modifications of the container of FIG. 1;

FIG. 9 is a top view of the new design, it being understood that the size and proportions of the top view of FIGS. 2–8 is identical hereto;

FIG. 10 is a front view of the new design of FIG. 1;

FIGS. 11–17 are front views of the new design of FIGS. 2–8, respectively;

FIGS. 18–21 are back views of the new design of FIGS. 1–4 and FIGS. 5–8, respectively; and,

FIG. 22 is a bottom view of the new design, it being understood that the size and proportions of the bottom view of FIGS. 2–8 is identical hereto.

The components of the container shown in broken lines are for illustrative purposes only and form no part of the claimed design.

1 Claim, 22 Drawing Sheets

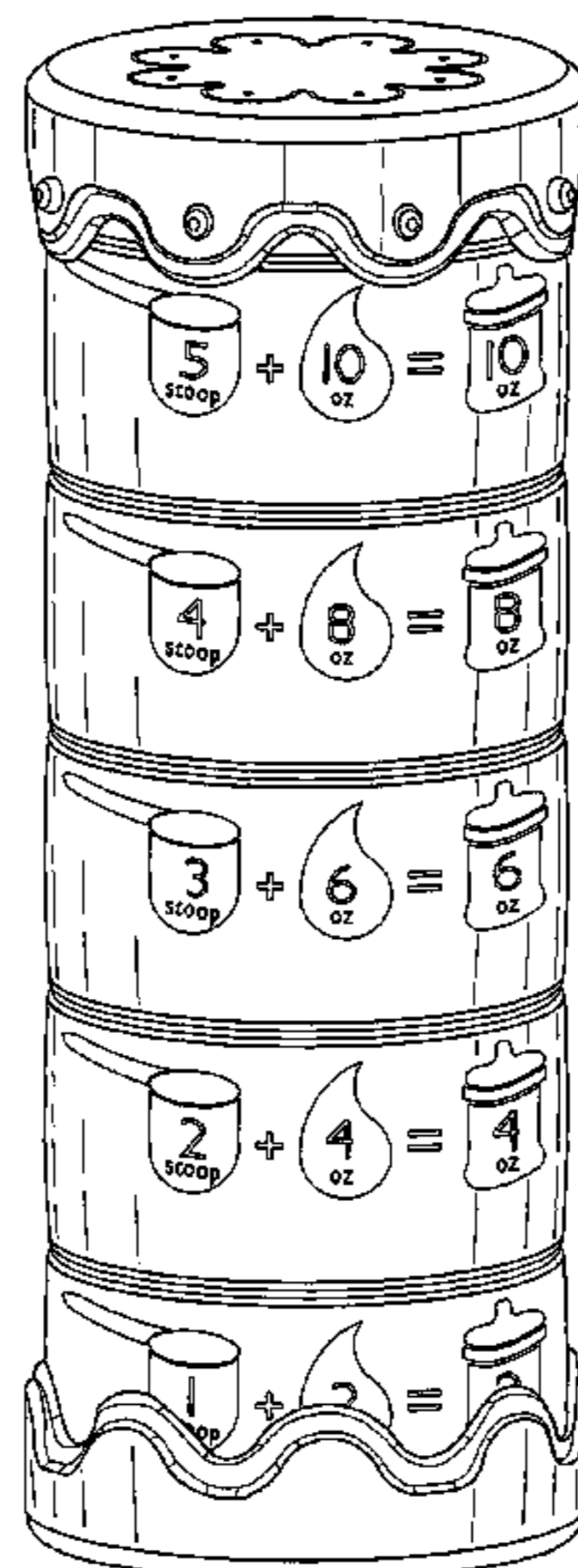

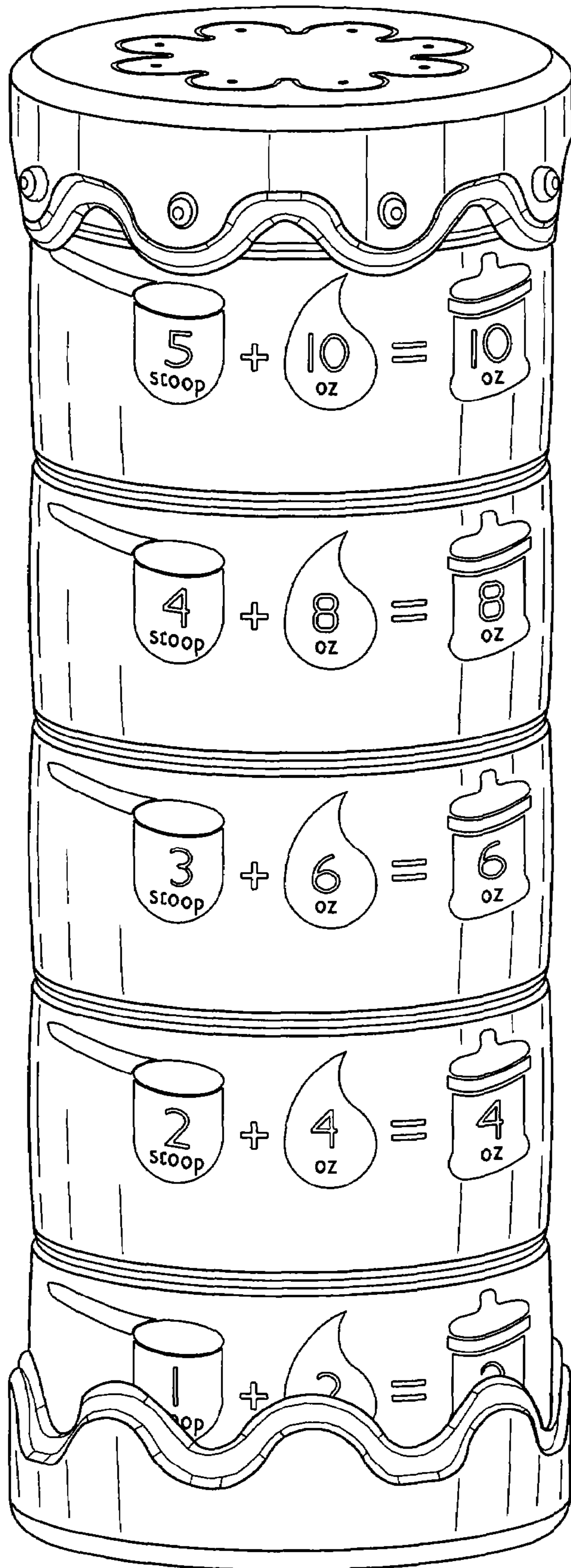

Fig. 1

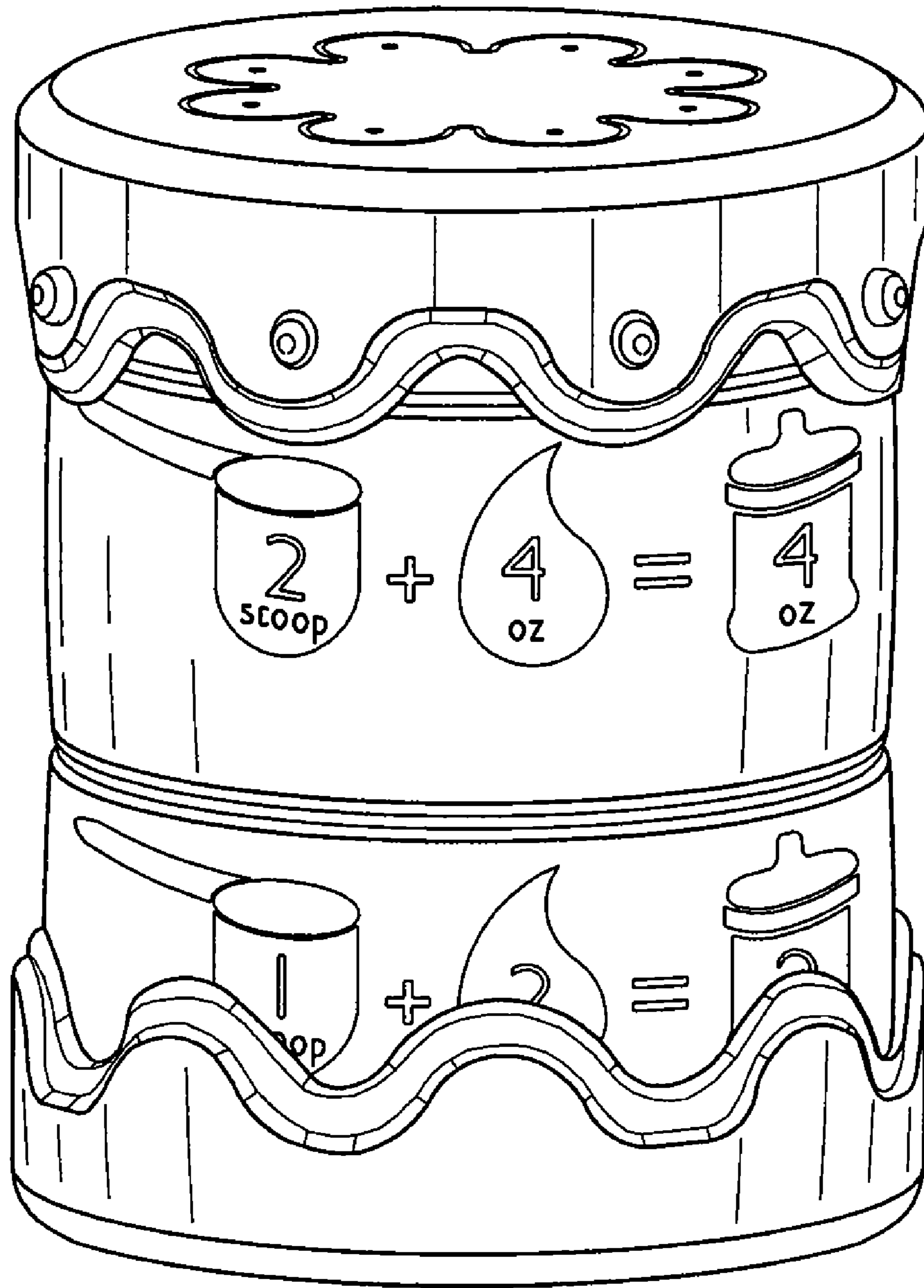

Fig. 2

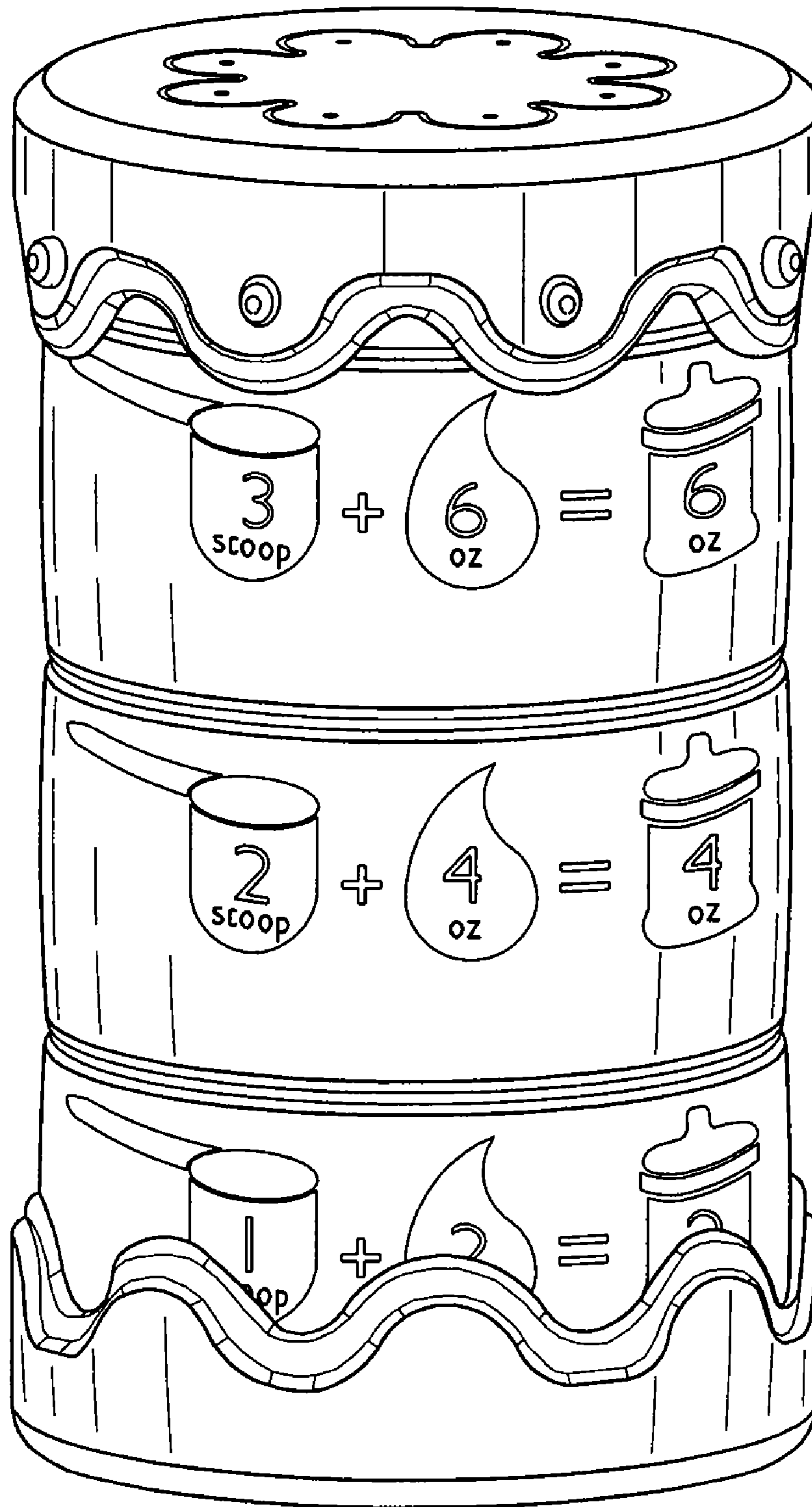

Fig. 3

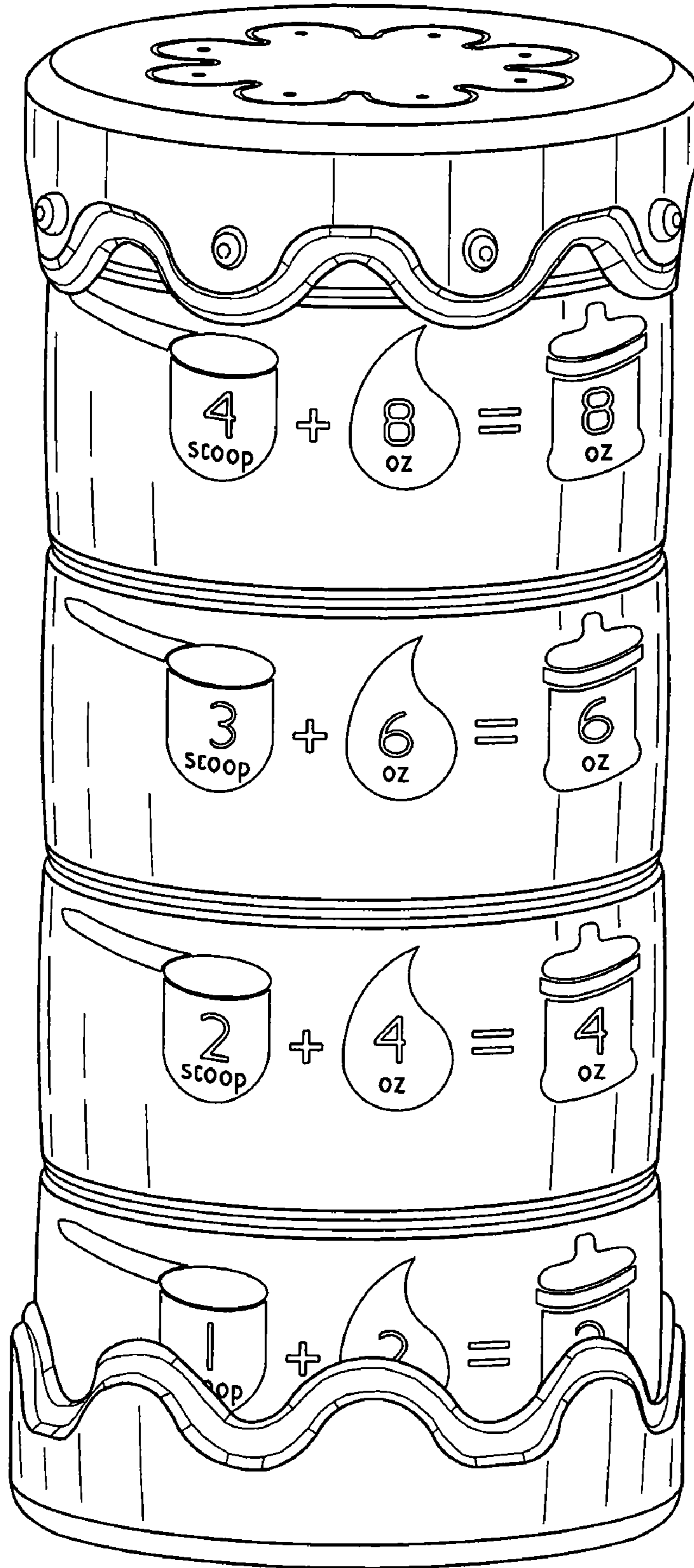

Fig. 4

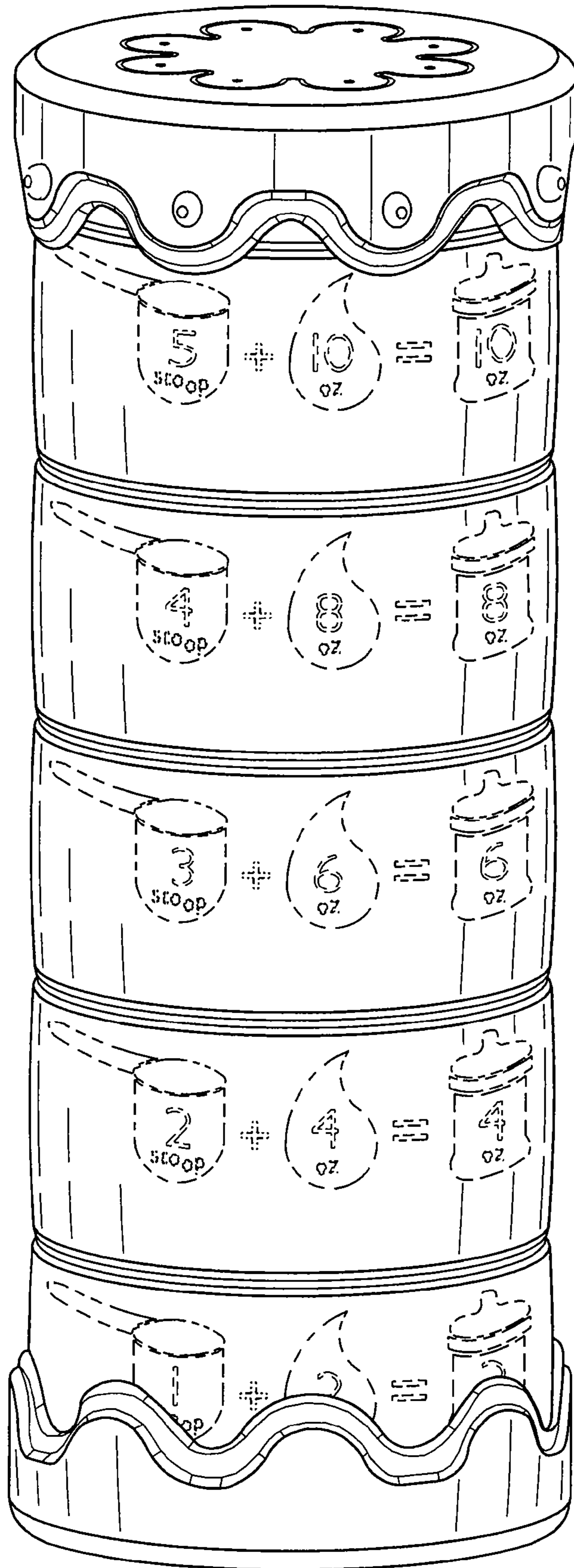

Fig. 5

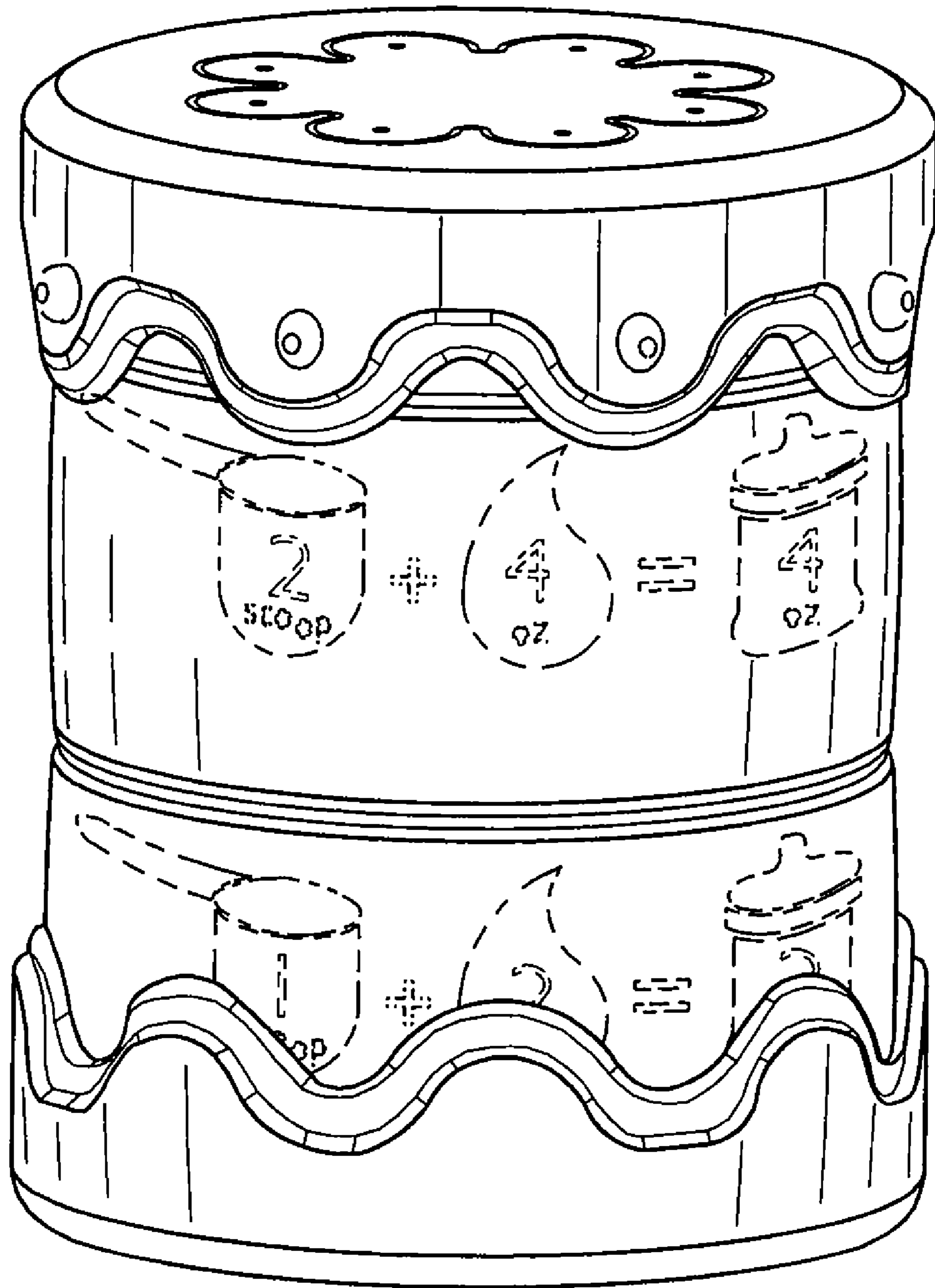

Fig. 6

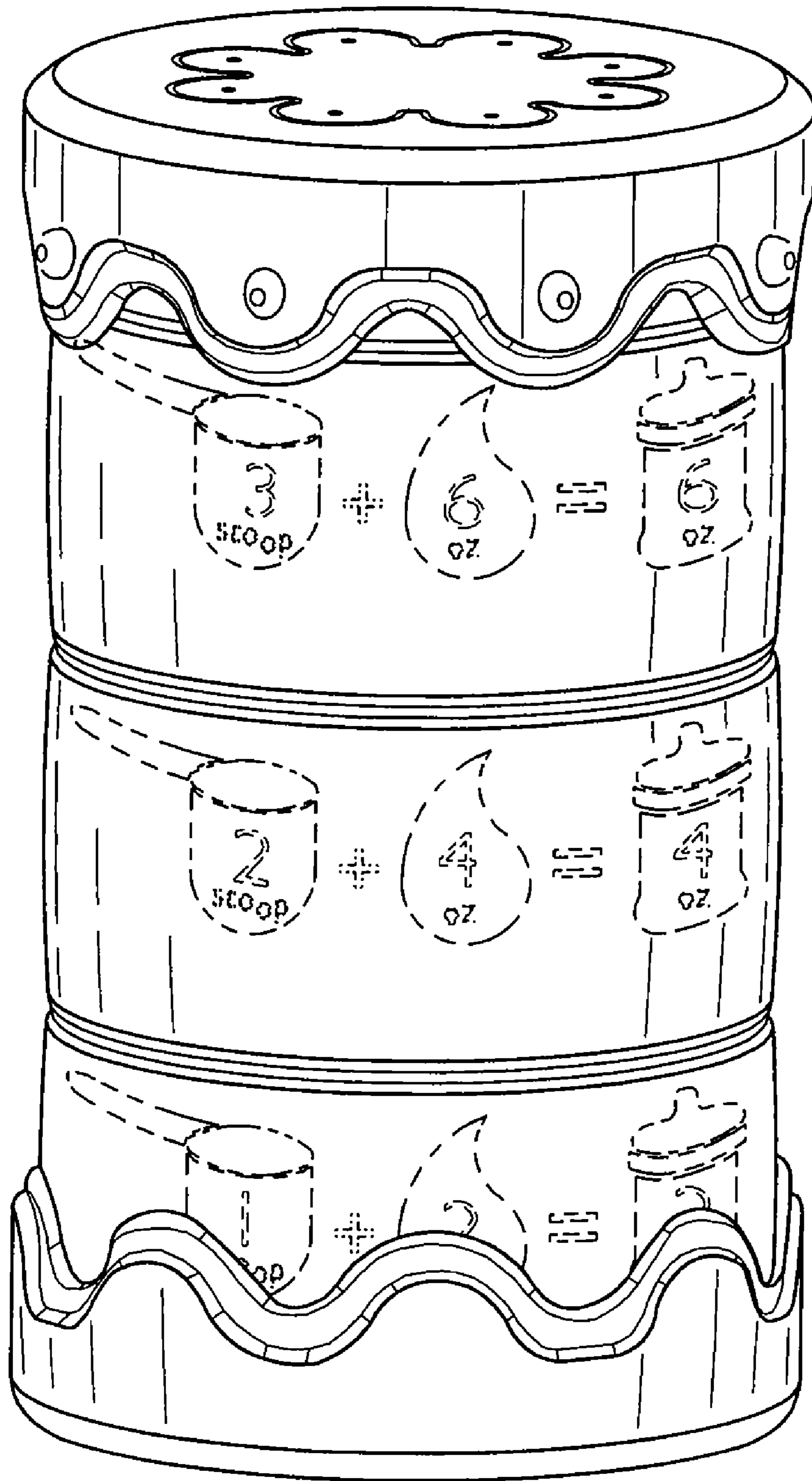

Fig. 7

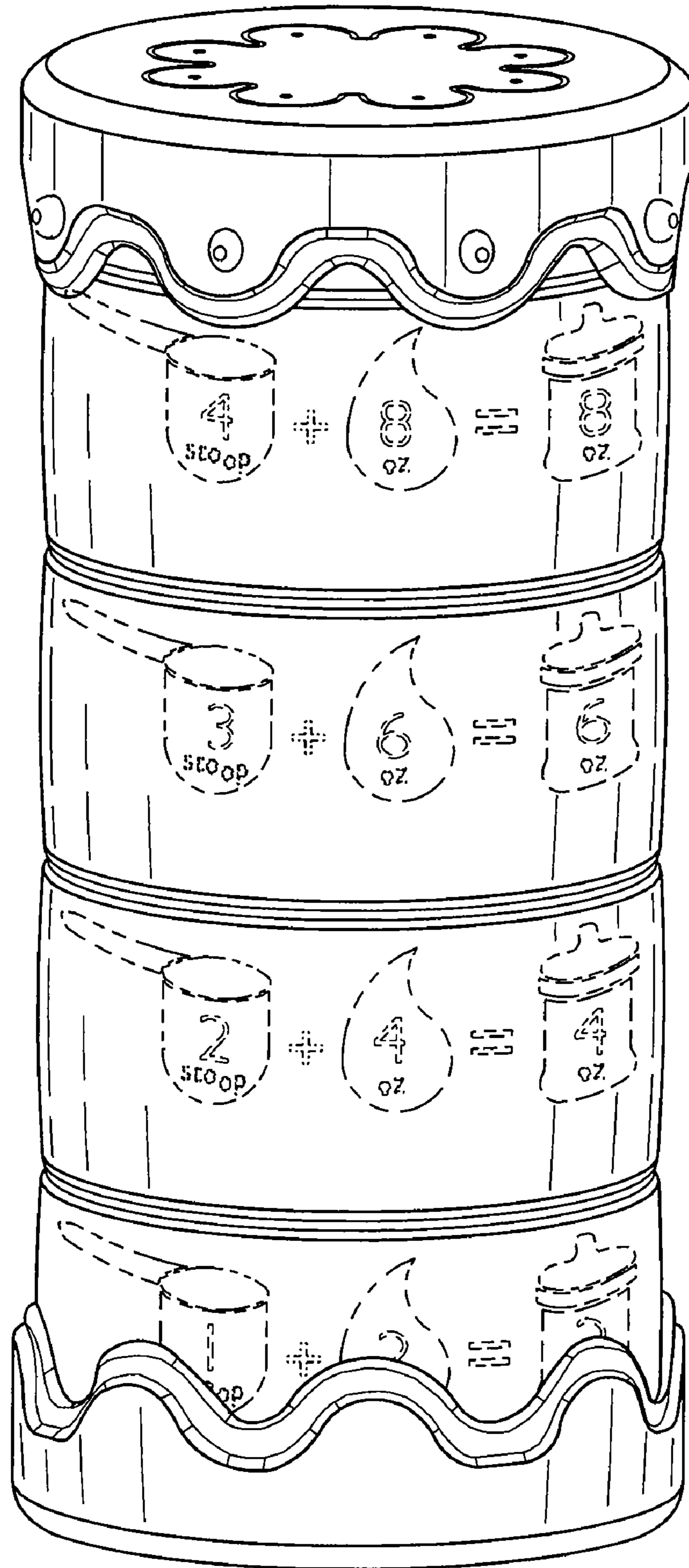

Fig. 8

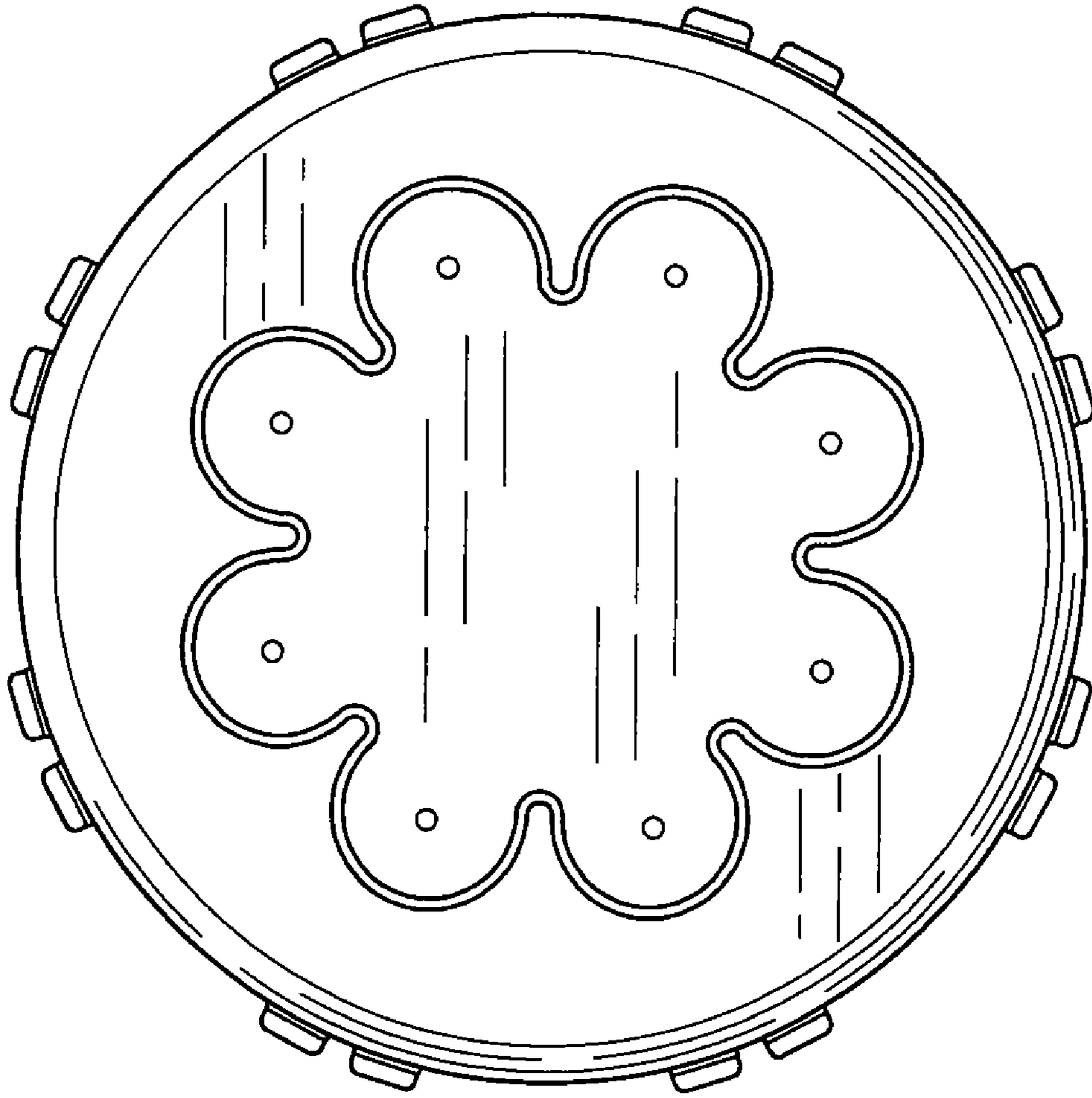

Fig. 9

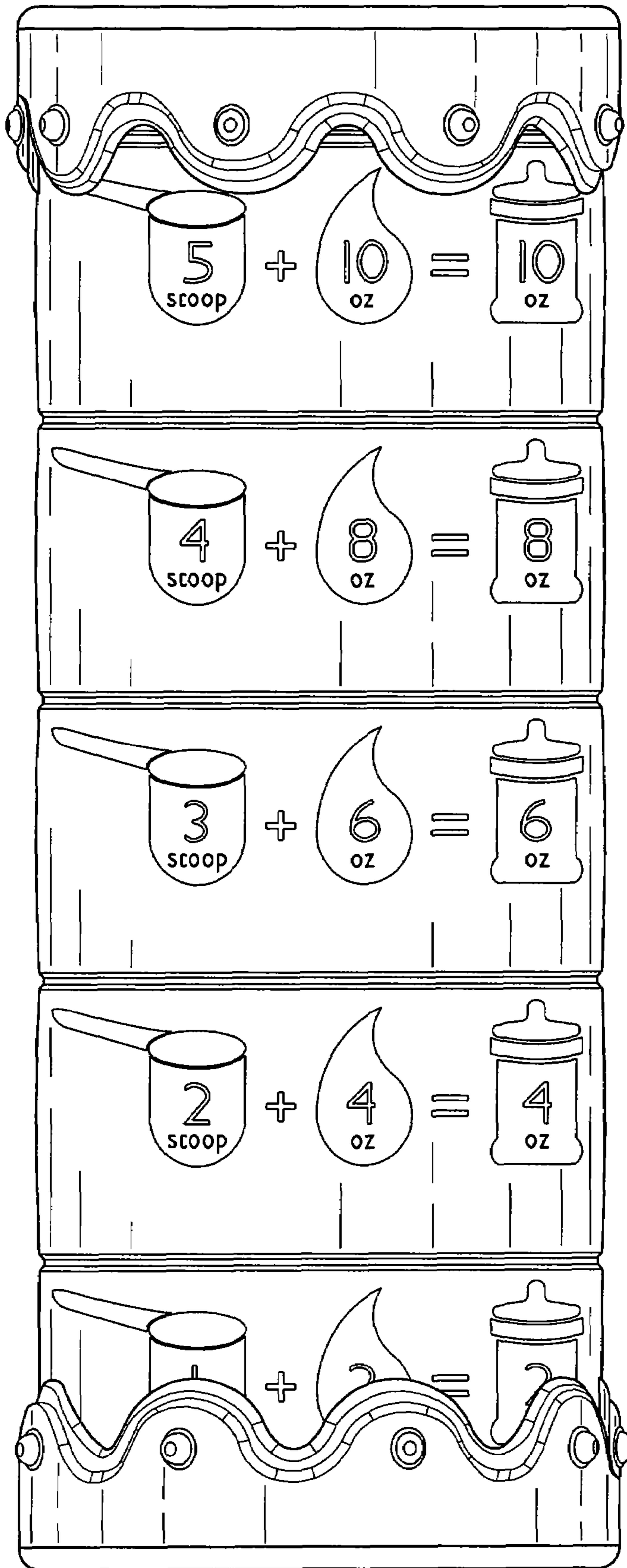

Fig. 10

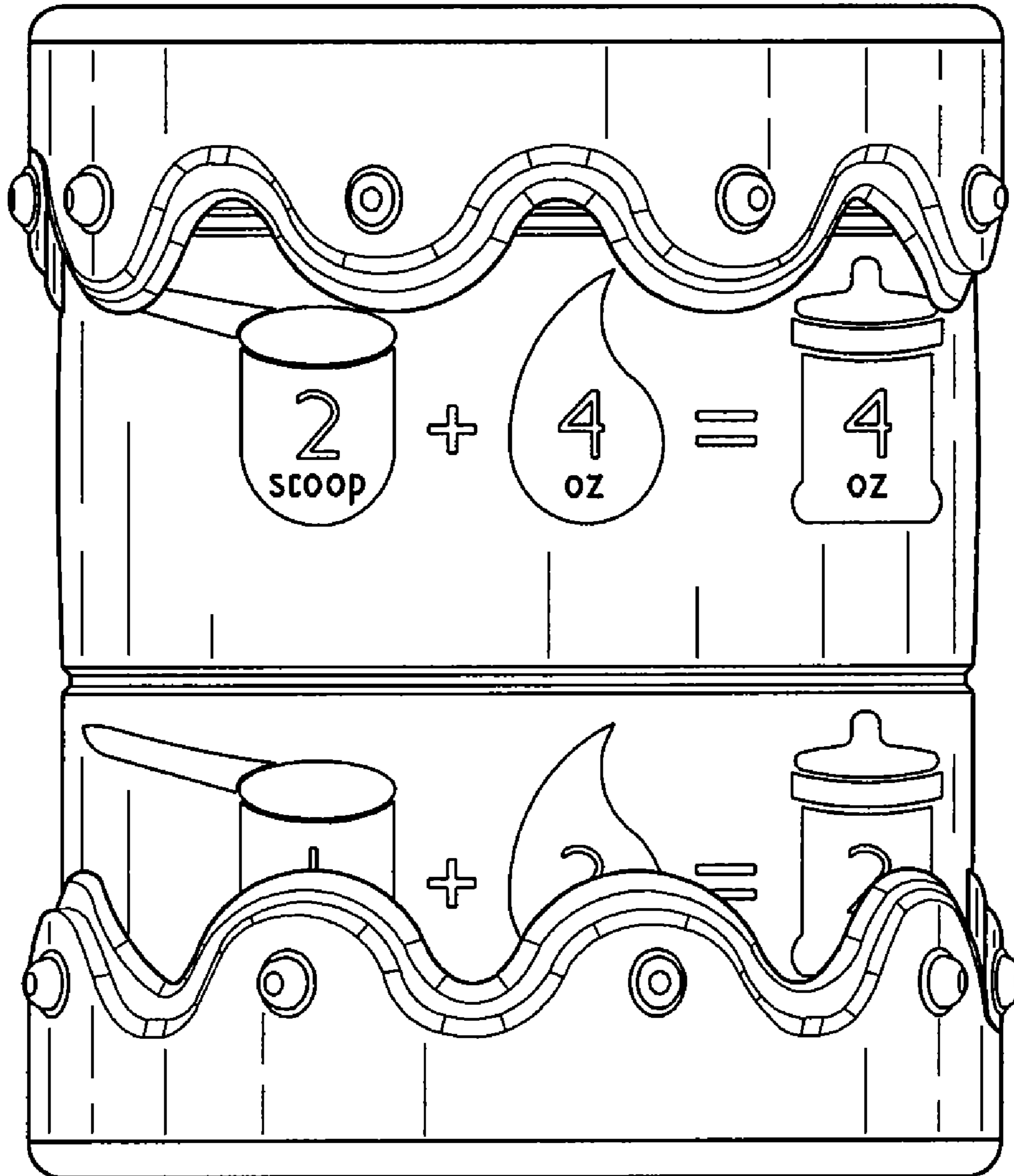

Fig. 11

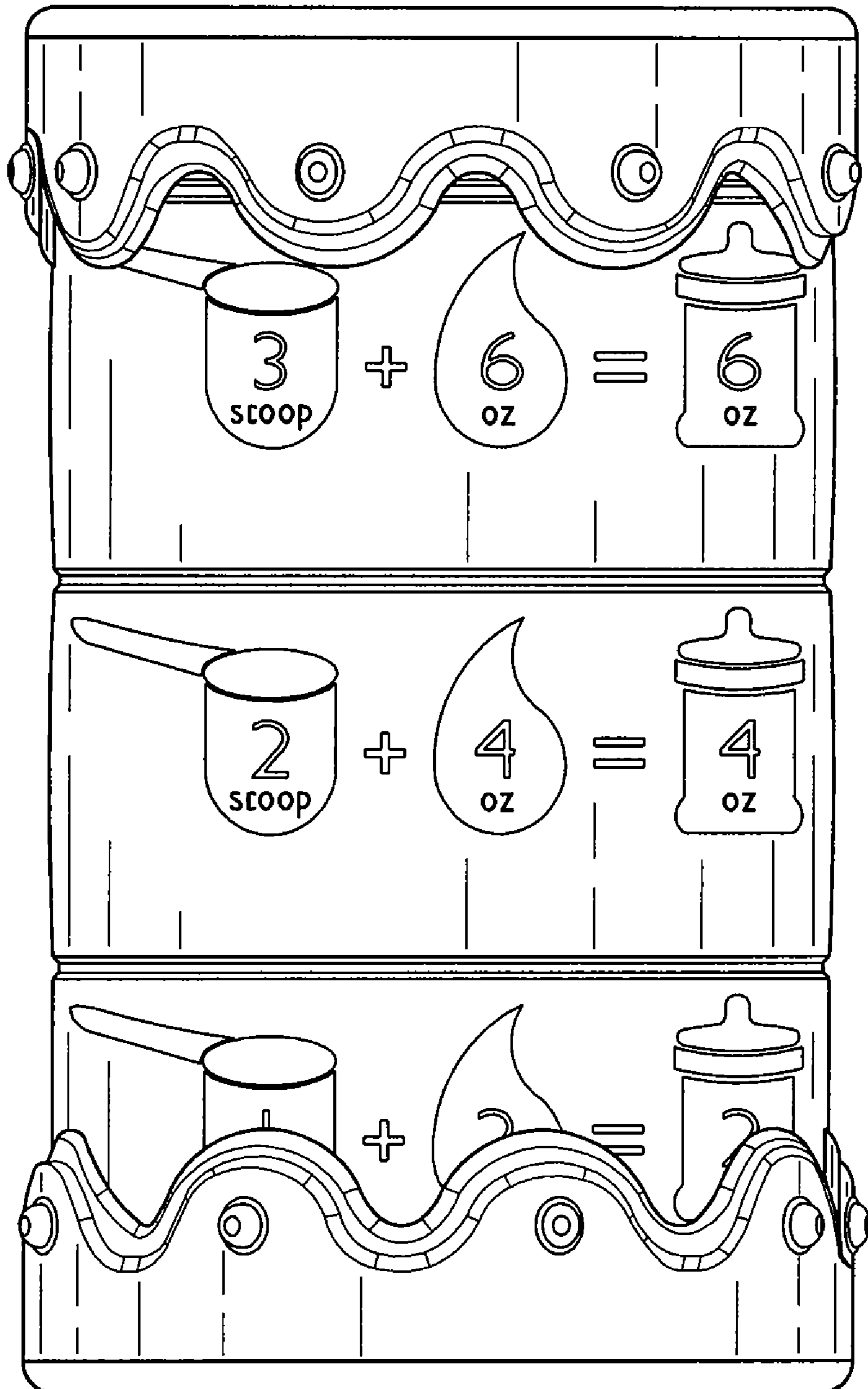

Fig. 12

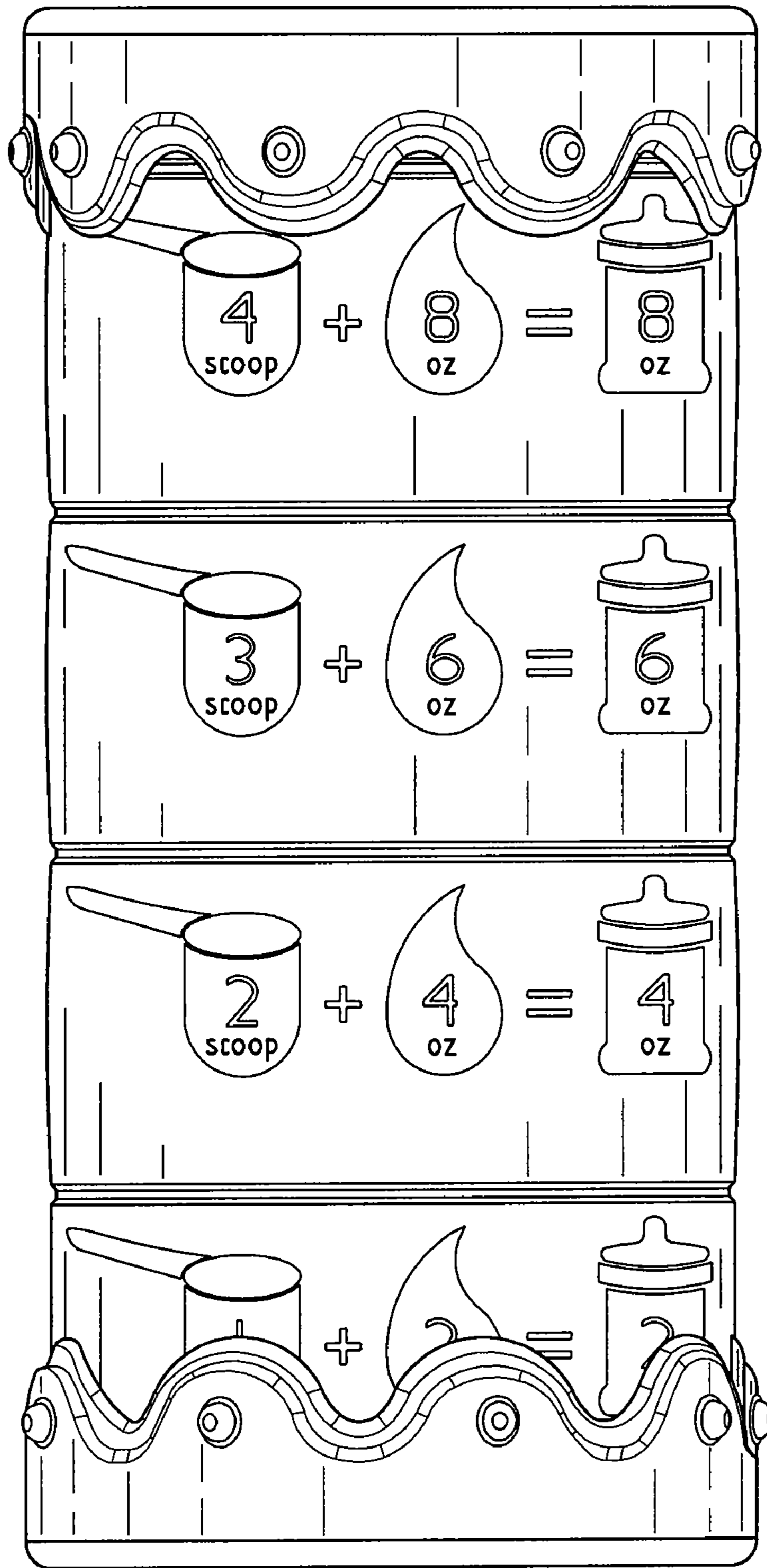

Fig. 13

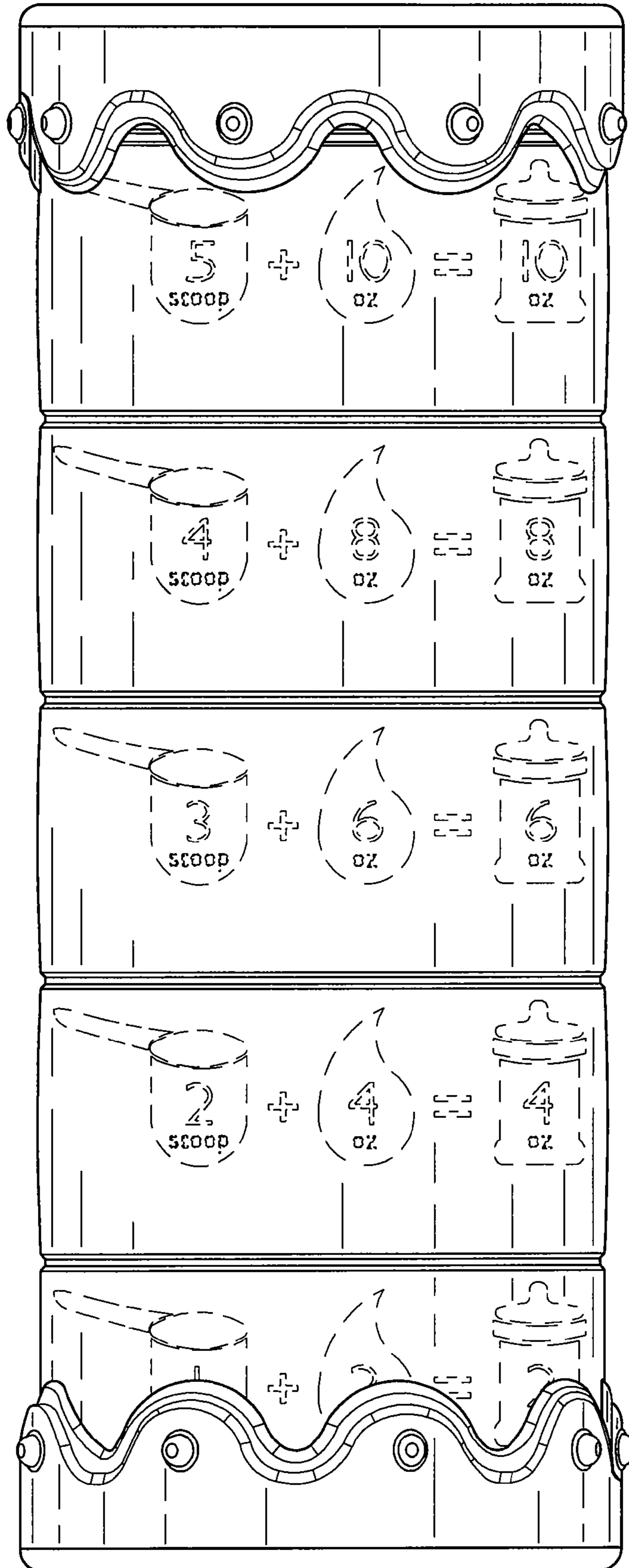

Fig. 14

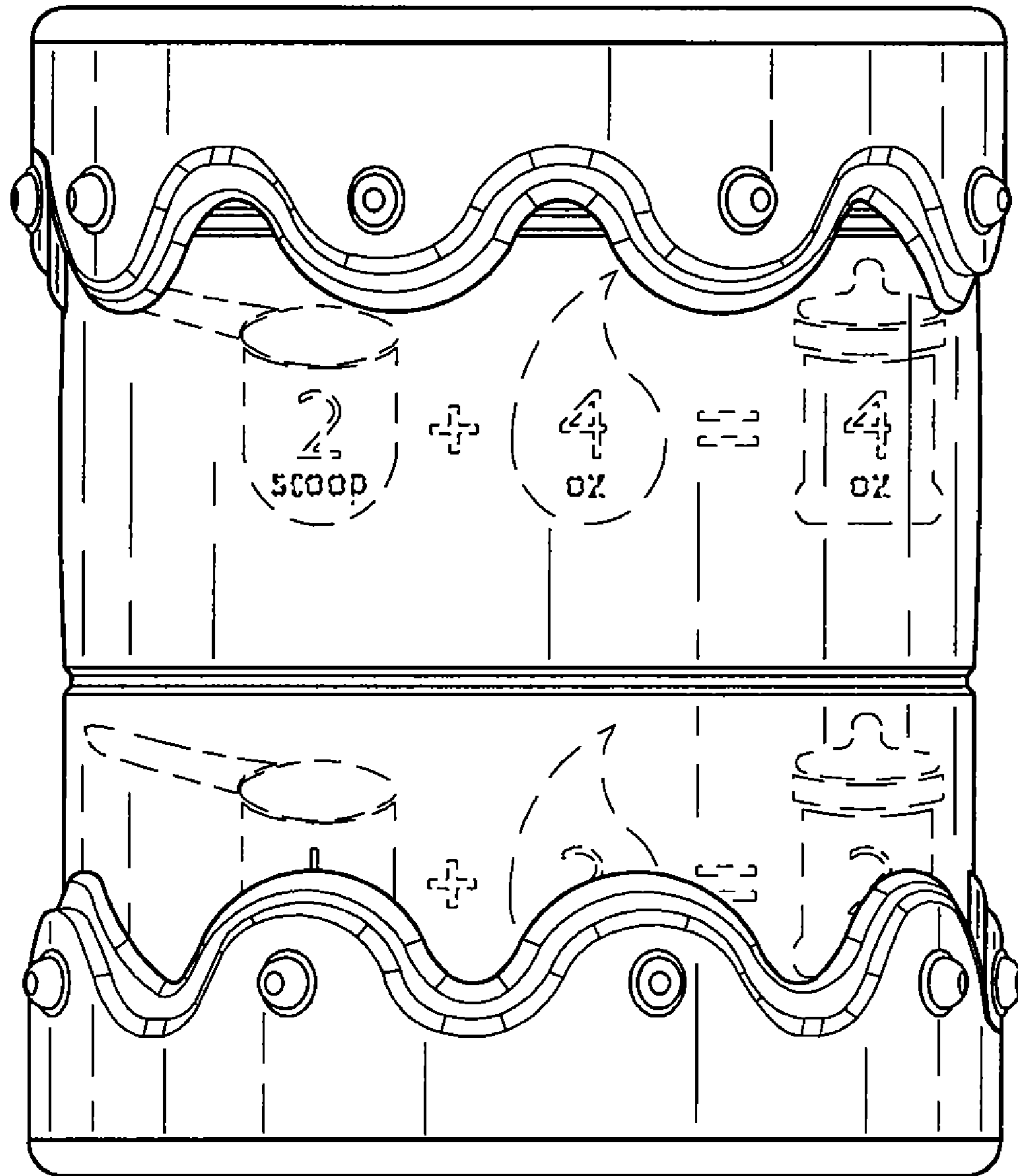

Fig. 15

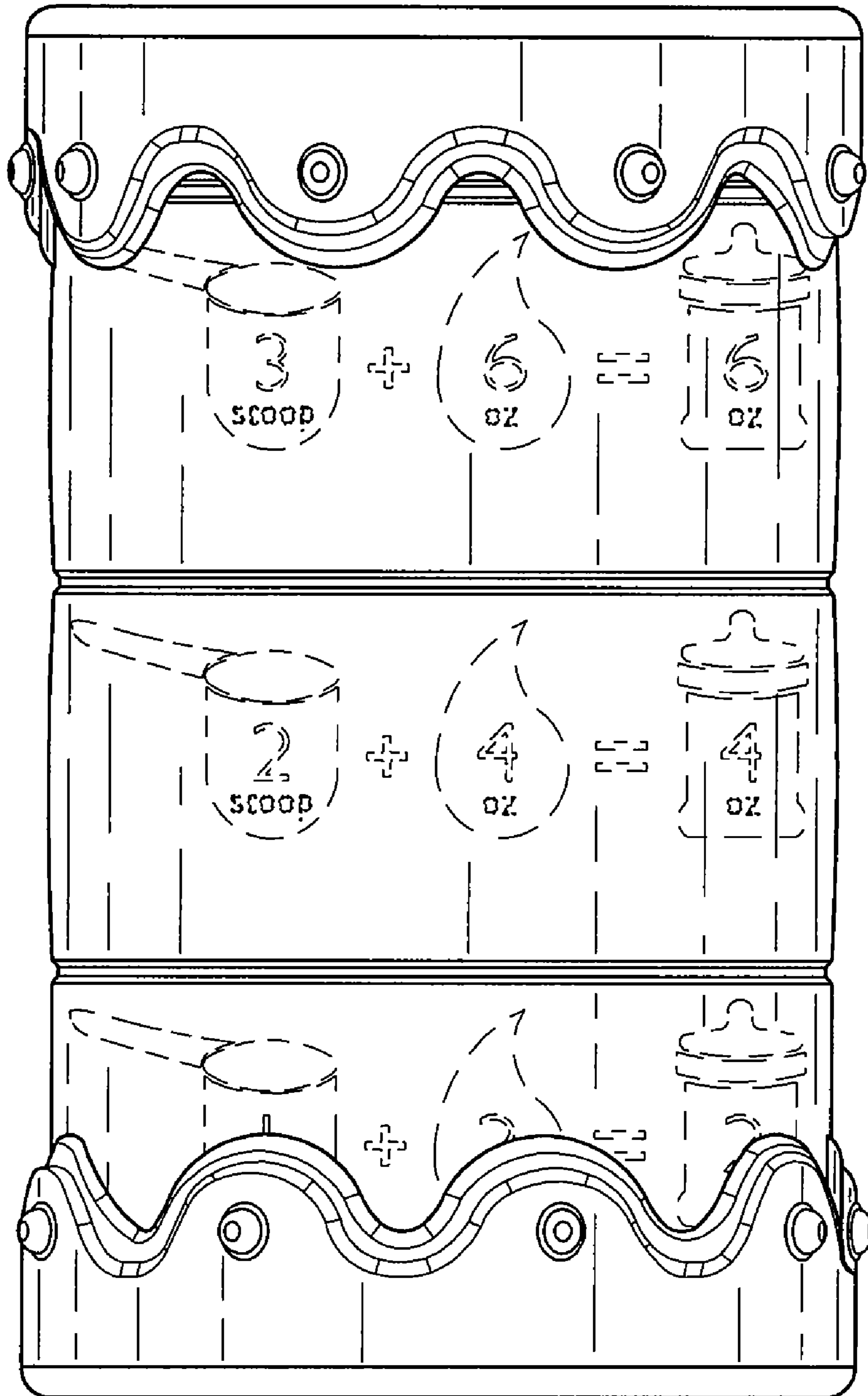

Fig. 16

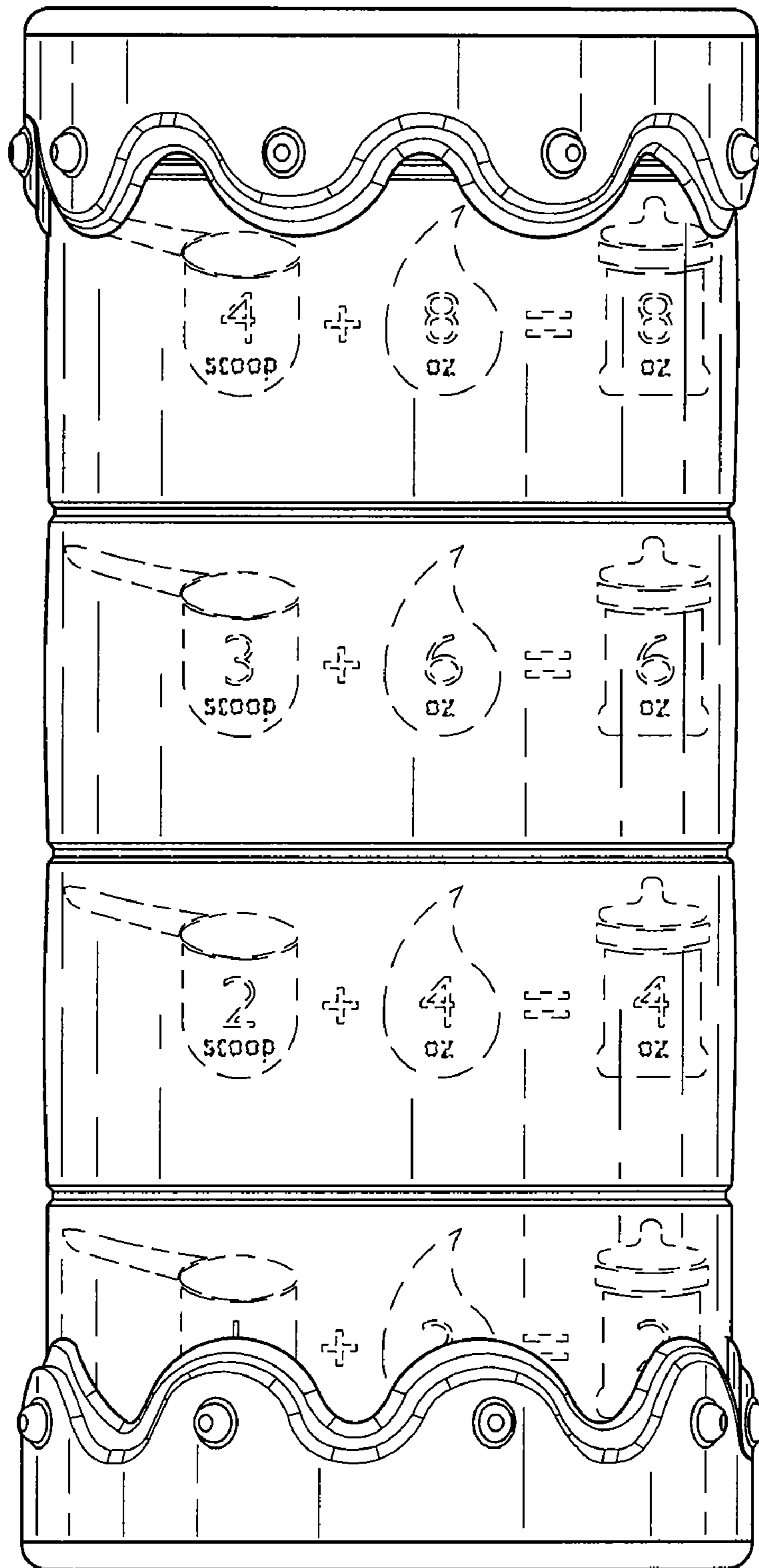

Fig. 17

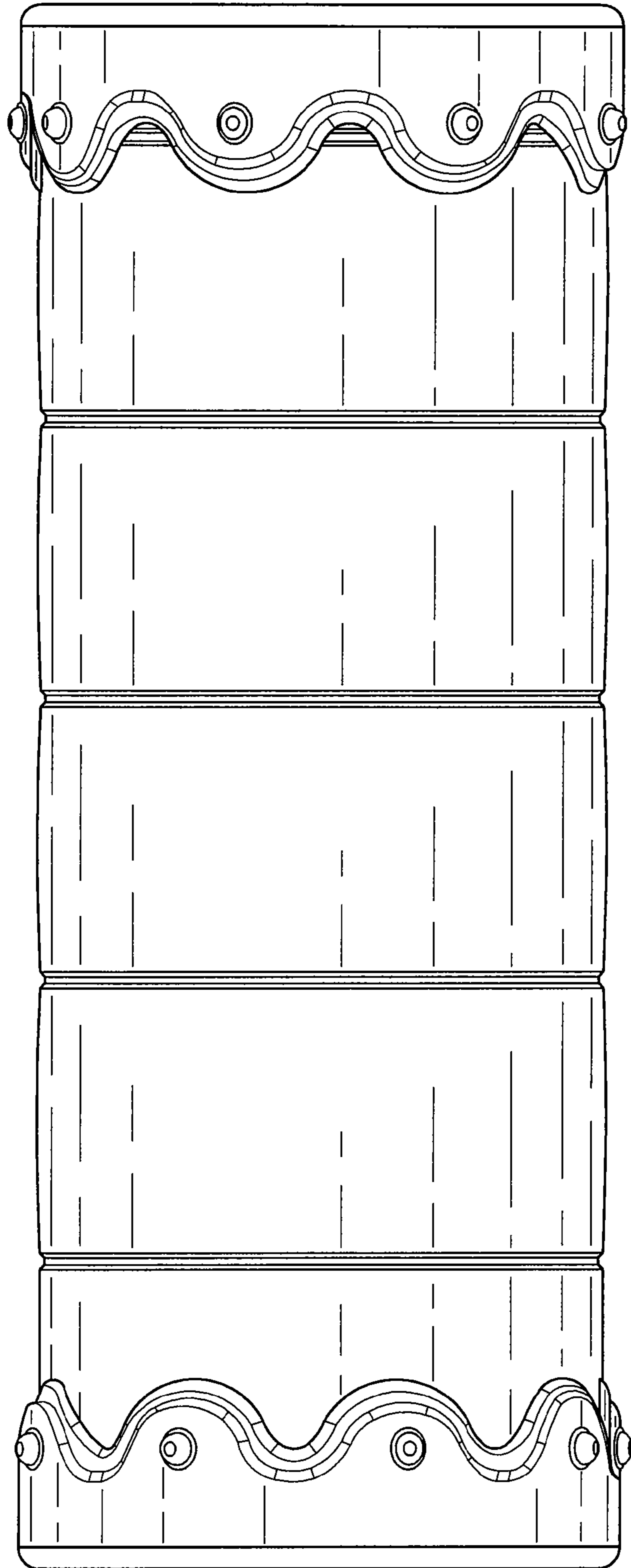

Fig. 18

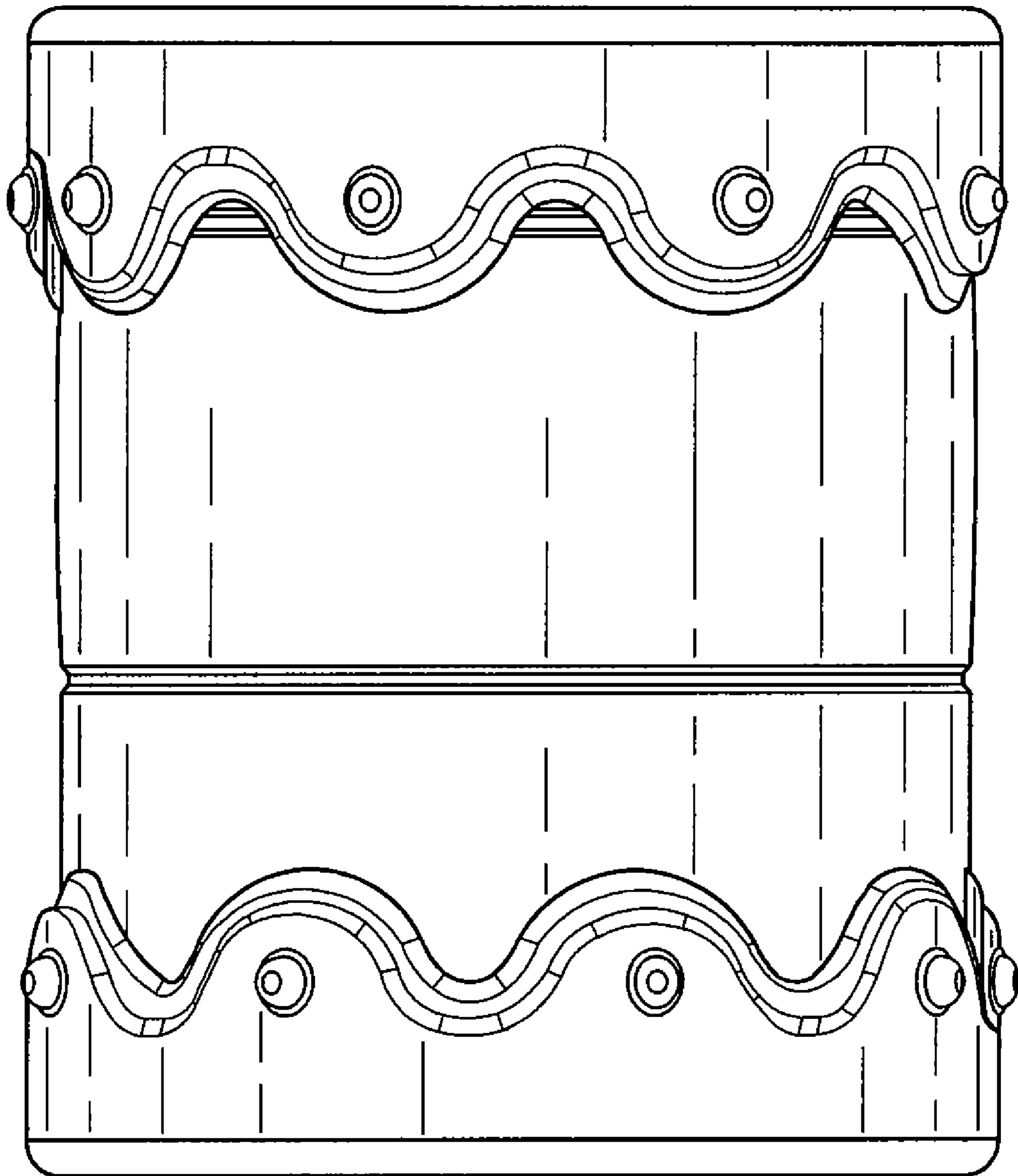

Fig. 19

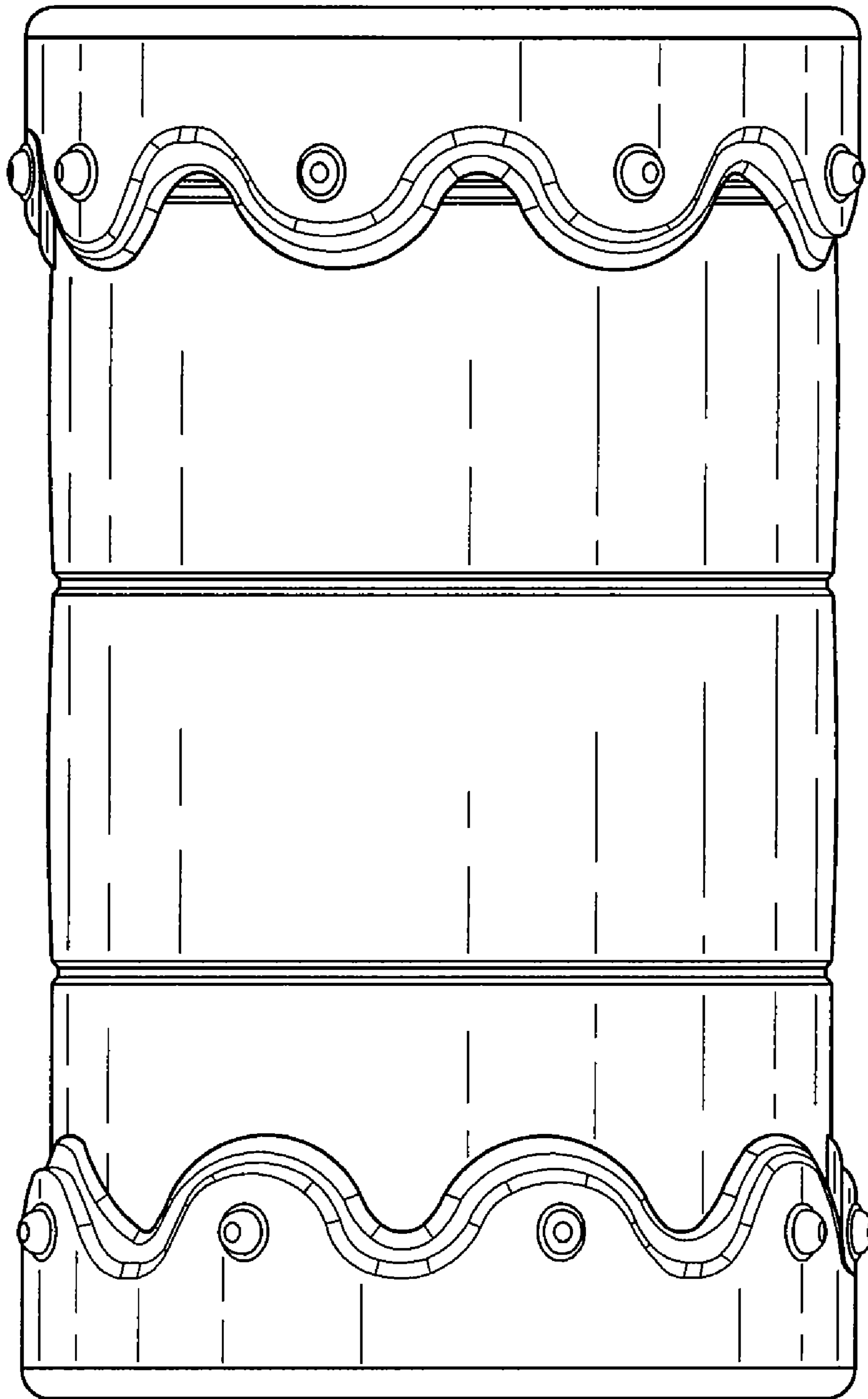

Fig. 20

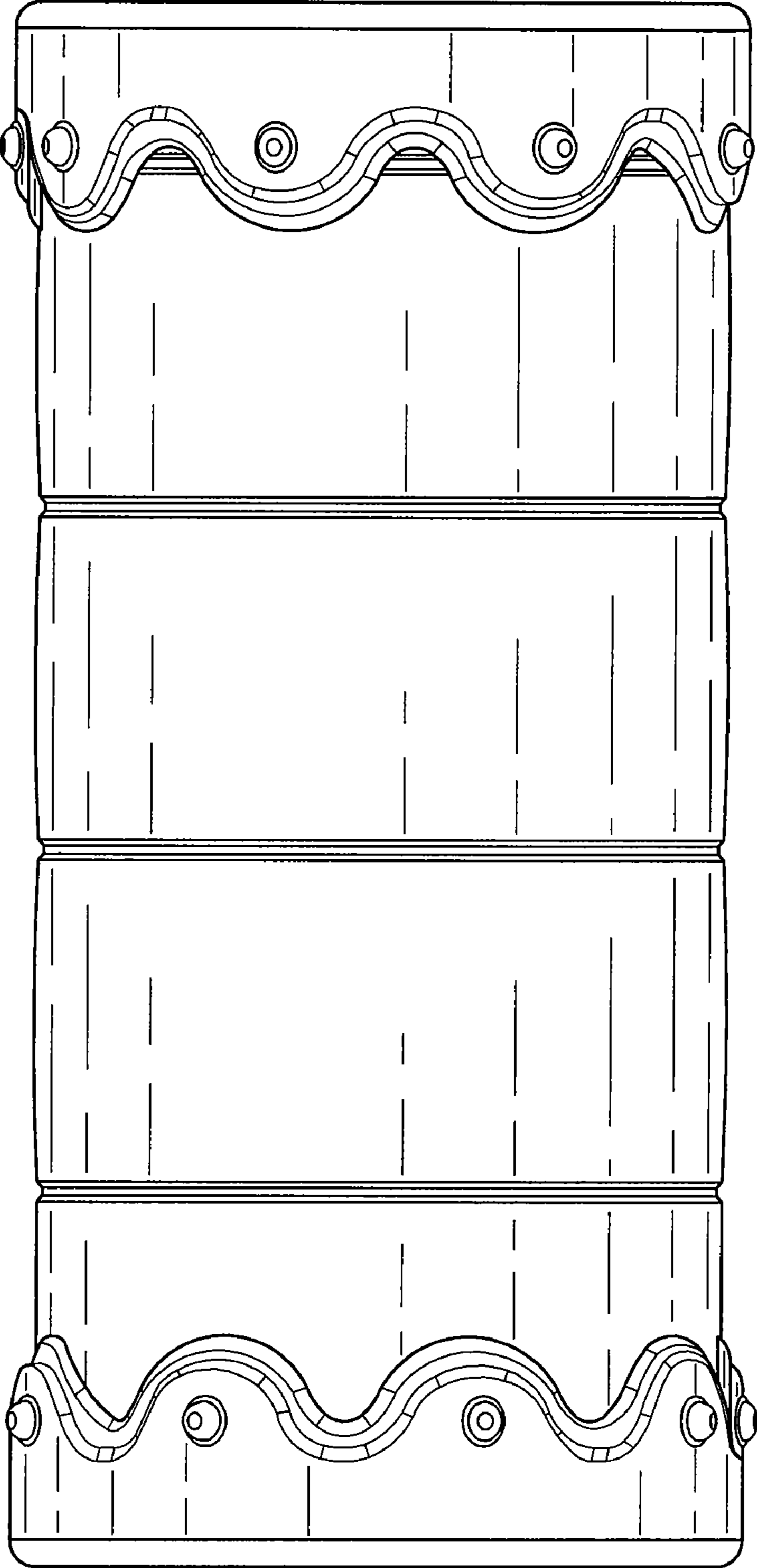

Fig. 21

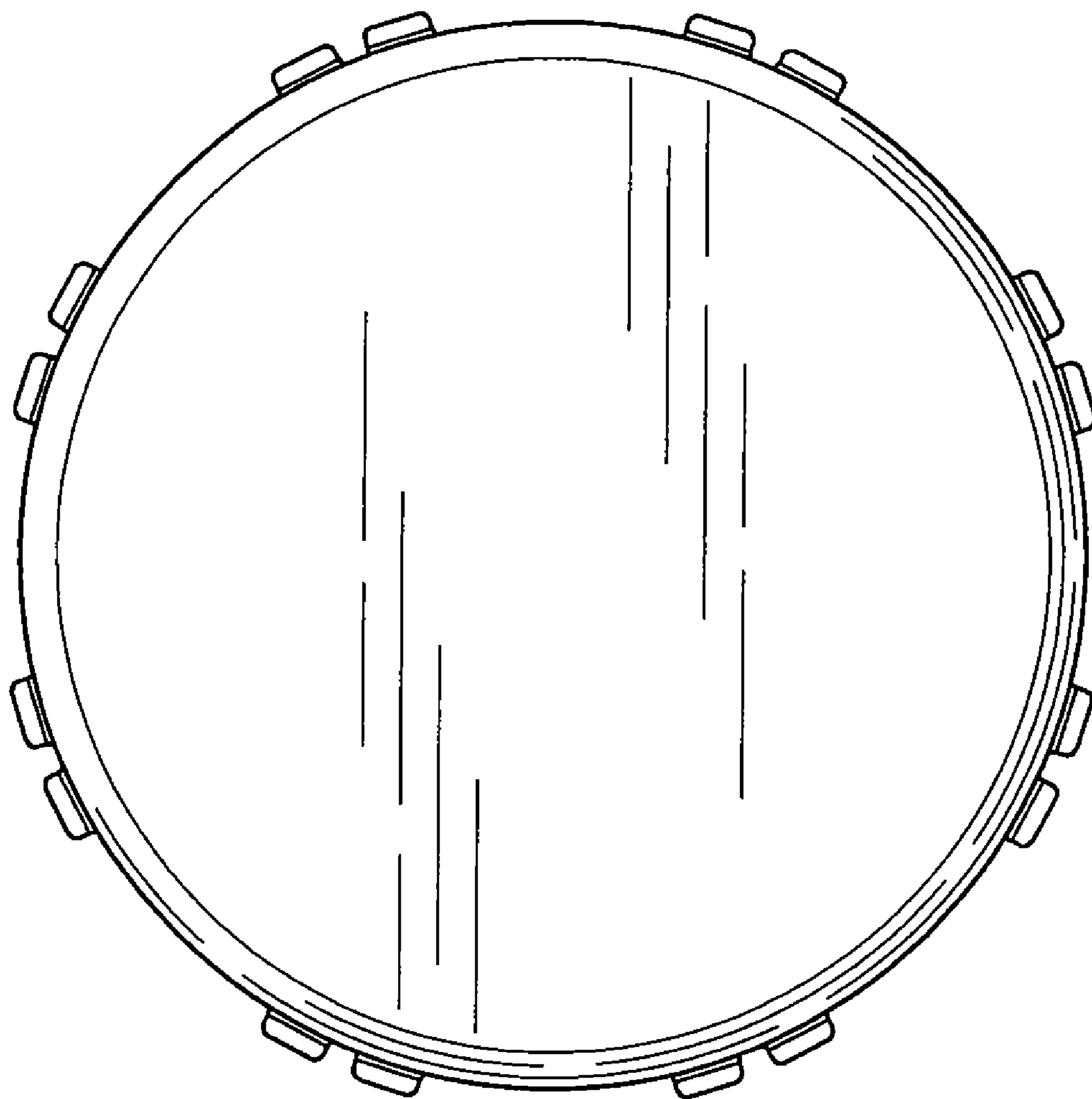

Fig. 22