



US00D579692S

(12) **United States Design Patent**
Canupp

(10) **Patent No.:** **US D579,692 S**

(45) **Date of Patent:** **** Nov. 4, 2008**

(54) **GIFT WRAPPING CONTAINER AND STATION**

(75) Inventor: **Vanessa Canupp**, 3960 Triton Ives Dr., Auburn, GA (US) 30011

(73) Assignee: **Vanessa Canupp**, Auburn, GA (US)

(**) Term: **14 Years**

(21) Appl. No.: **29/245,562**

(22) Filed: **Dec. 23, 2005**

(51) **LOC (8) Cl.** **06-04**

(52) **U.S. Cl.** **D6/467**

(58) **Field of Classification Search** D6/396,
D6/432, 436, 449, 467, 468, 474–476, 512;
D9/424, 430, 432; D19/75; D3/304, 316;
229/923; 312/117, 126, 130, 902; 206/223,
206/225, 227, 391, 557, 558, 561; 211/126.1,
211/126.13; 223/107; 220/500–505, 553–555,
220/507

See application file for complete search history.

(56) **References Cited**

U.S. PATENT DOCUMENTS

242,607 A	6/1881	Cutler	
2,135,238 A	11/1938	Malik	
D147,025 S *	7/1947	Shepard	D9/756
D163,210 S *	5/1951	Long	D3/204
3,302,781 A	2/1967	Rudnick	
4,186,833 A	2/1980	Homan	
4,369,929 A	1/1983	Cayer	
4,796,792 A	1/1989	Nelson et al.	
D306,234 S *	2/1990	Ferstl	D19/75
D335,896 S *	5/1993	Evenson	D19/83
5,257,721 A	11/1993	Smith et al.	
D348,584 S *	7/1994	Sankey	D6/632
5,425,486 A *	6/1995	Kurker	225/46

(Continued)

Primary Examiner—Caron D. Veynar

Assistant Examiner—Abraham Bahta

(74) *Attorney, Agent, or Firm*—Ballard, Spahr, Andrews & Ingersoll, LLP

(57) **CLAIM**

The ornamental design for a gift wrapping container and station, as shown and described.

DESCRIPTION

FIG. 1 is a perspective view of the design of the present invention for a gift wrapping container and station, shown in a closed position;

FIG. 2 is a left side plan view of the design of FIG. 1, of which the right side is a mirror image thereof;

FIG. 3 is a front plan view of the design of FIG. 1;

FIG. 4 is a rear plan view of the design of FIG. 1;

FIG. 5 is a top plan view of the design of FIG. 1;

FIG. 6 is a bottom plan view of the design of FIG. 1;

FIG. 7 is a perspective view of the gift wrapping container and station, shown in an open position and showing a pair of storage doors in a raised position;

FIG. 8 is a left side plan view of the design of FIG. 7, shown in an open position and showing a pair of storage doors in a lowered position, of which the right side is a mirror image thereof;

FIG. 9 is a top plan view of the design of FIG. 8;

FIG. 10 is a cross-sectional view of the design of FIG. 8, taken along line 10—10 of FIG. 8; and,

FIG. 11 is a cross-sectional view of the design of FIG. 8, taken along line 11—11 of FIG. 9.

The broken lines shown are for illustrative purposes and form no part of the claimed design.

1 Claim, 6 Drawing Sheets

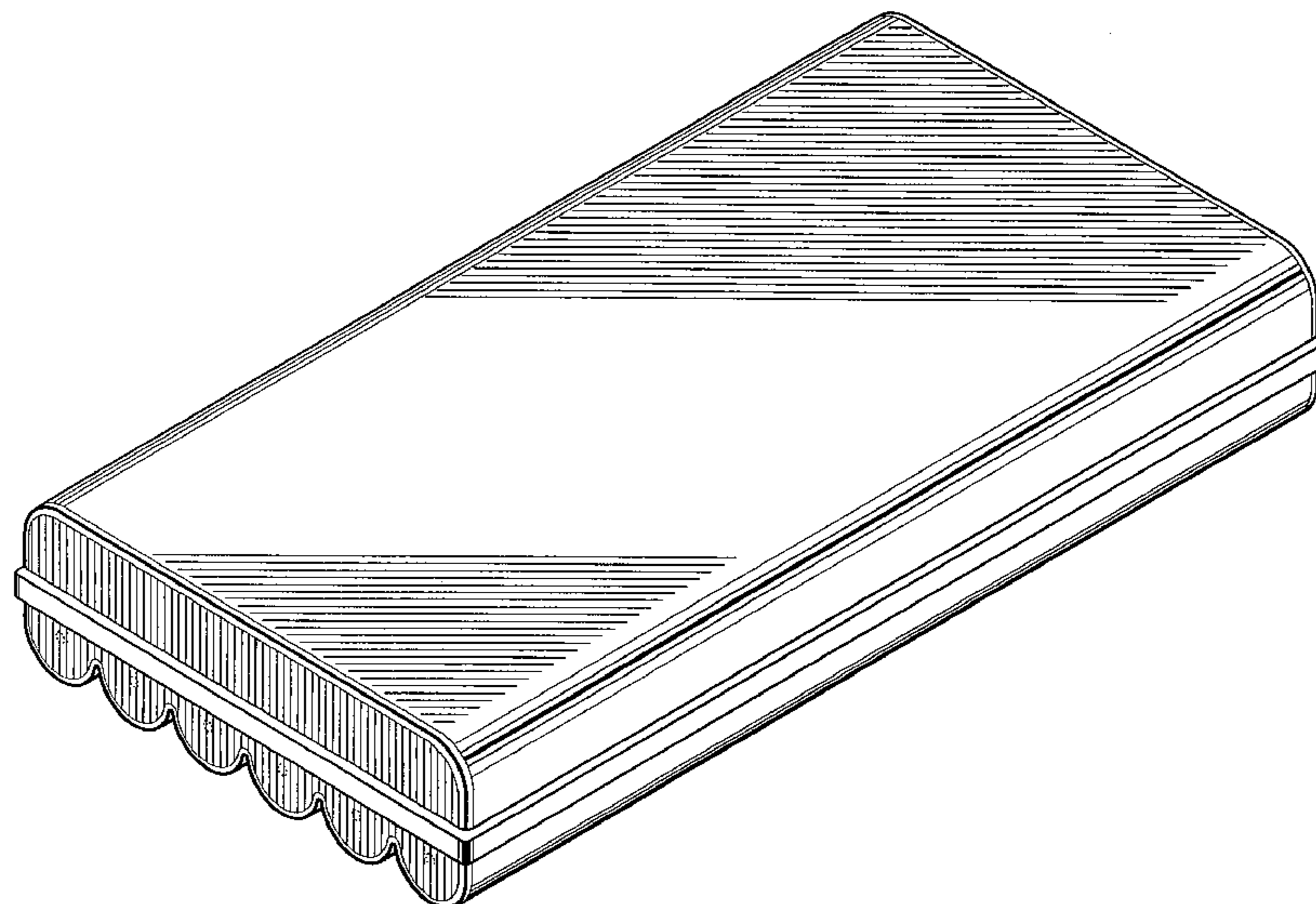

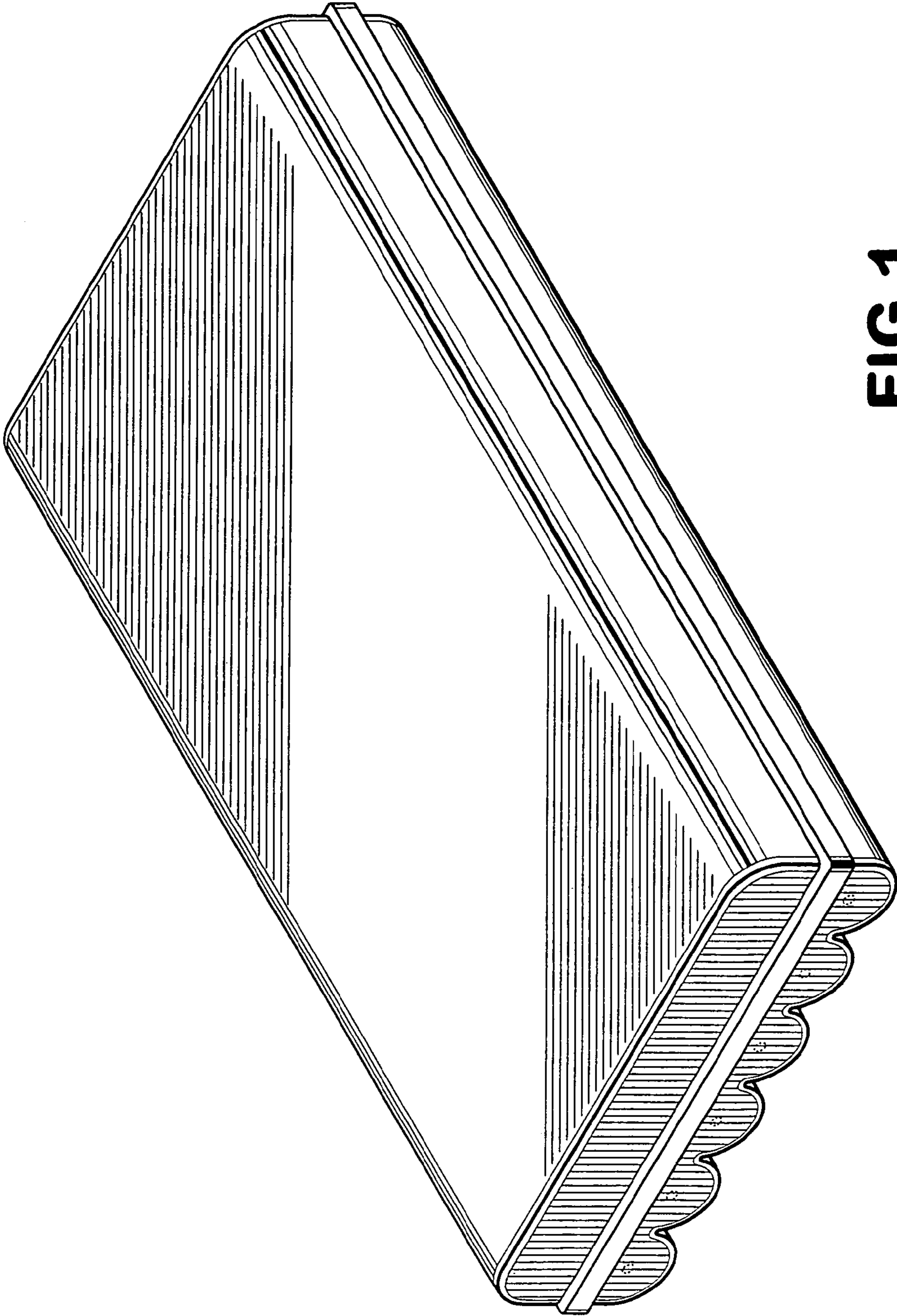

FIG 1

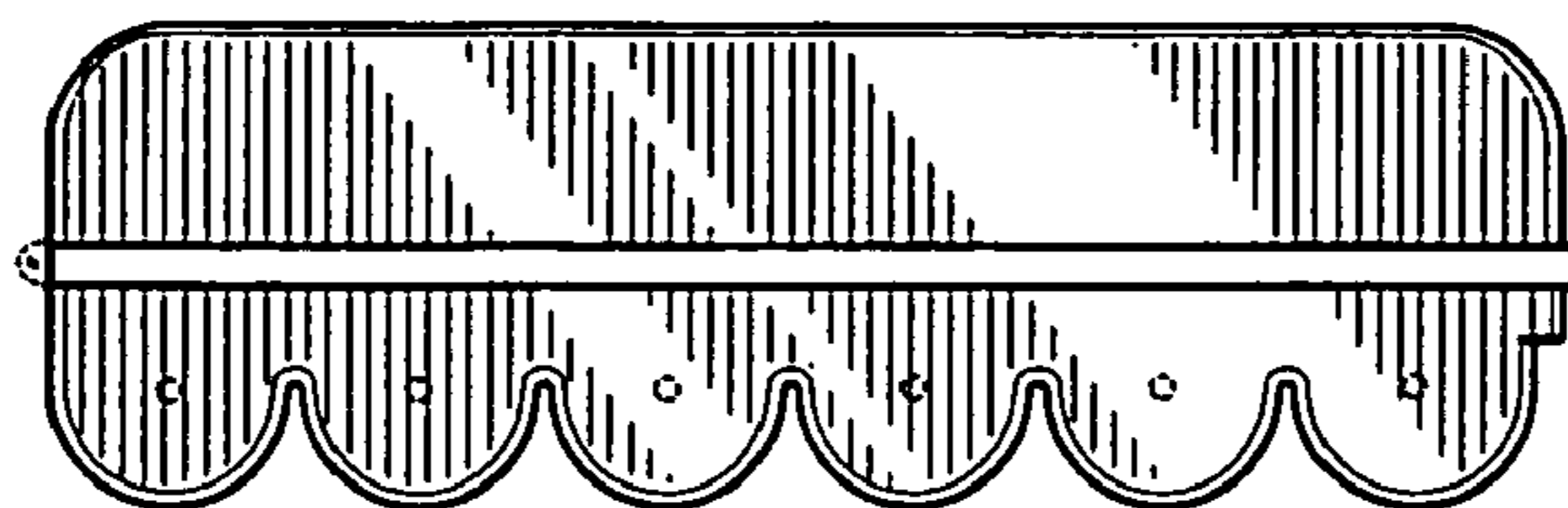

FIG 2

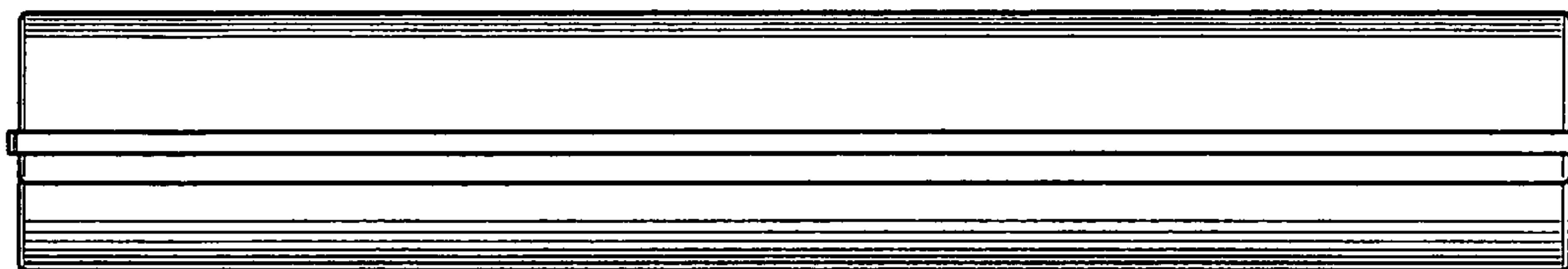

FIG 3

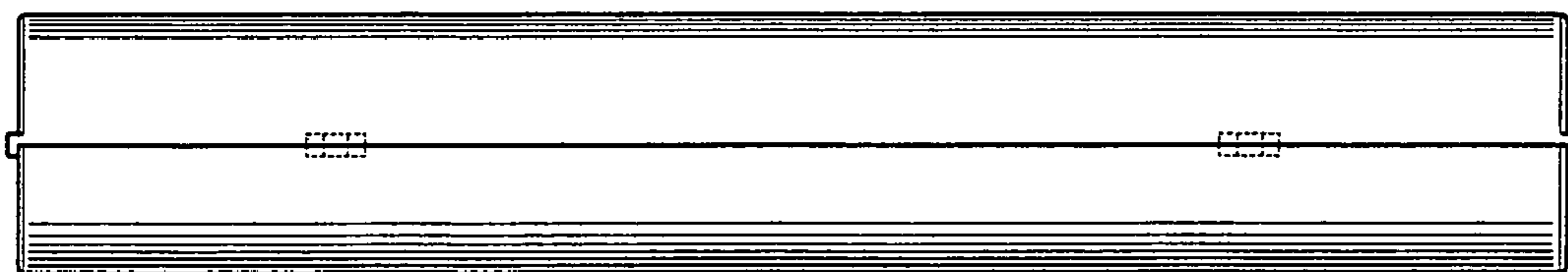

FIG 4

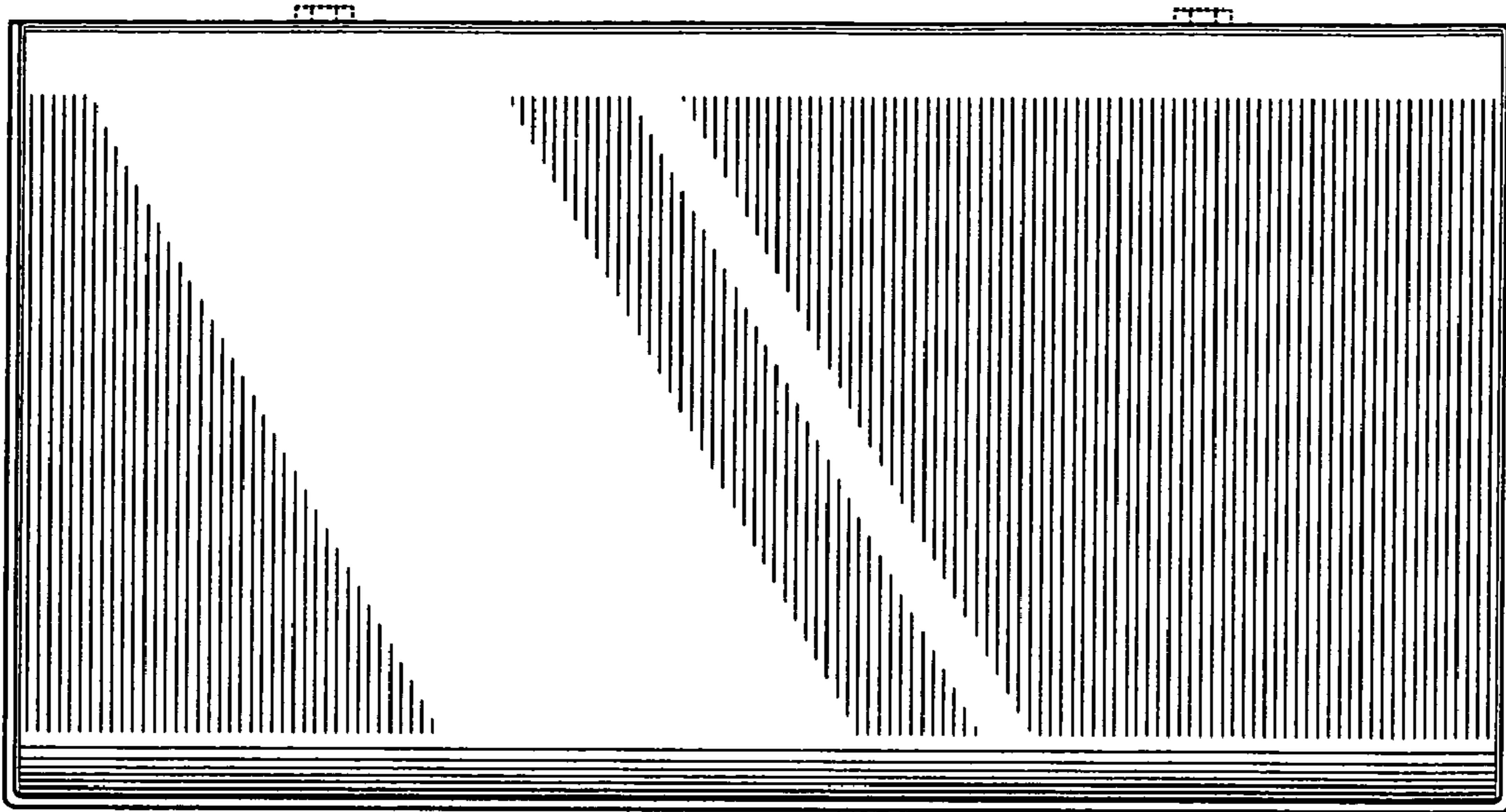

FIG 5

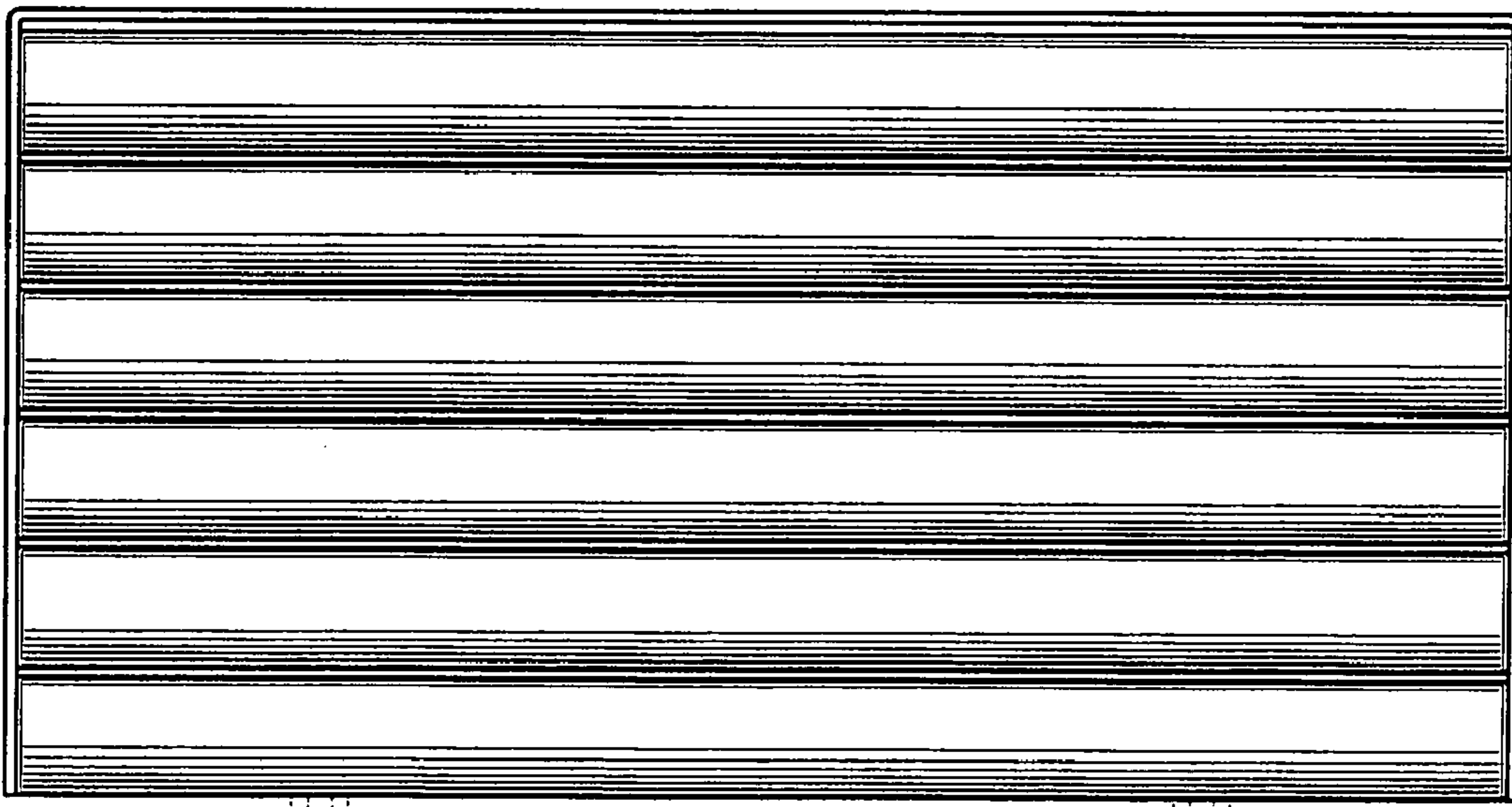

FIG 6

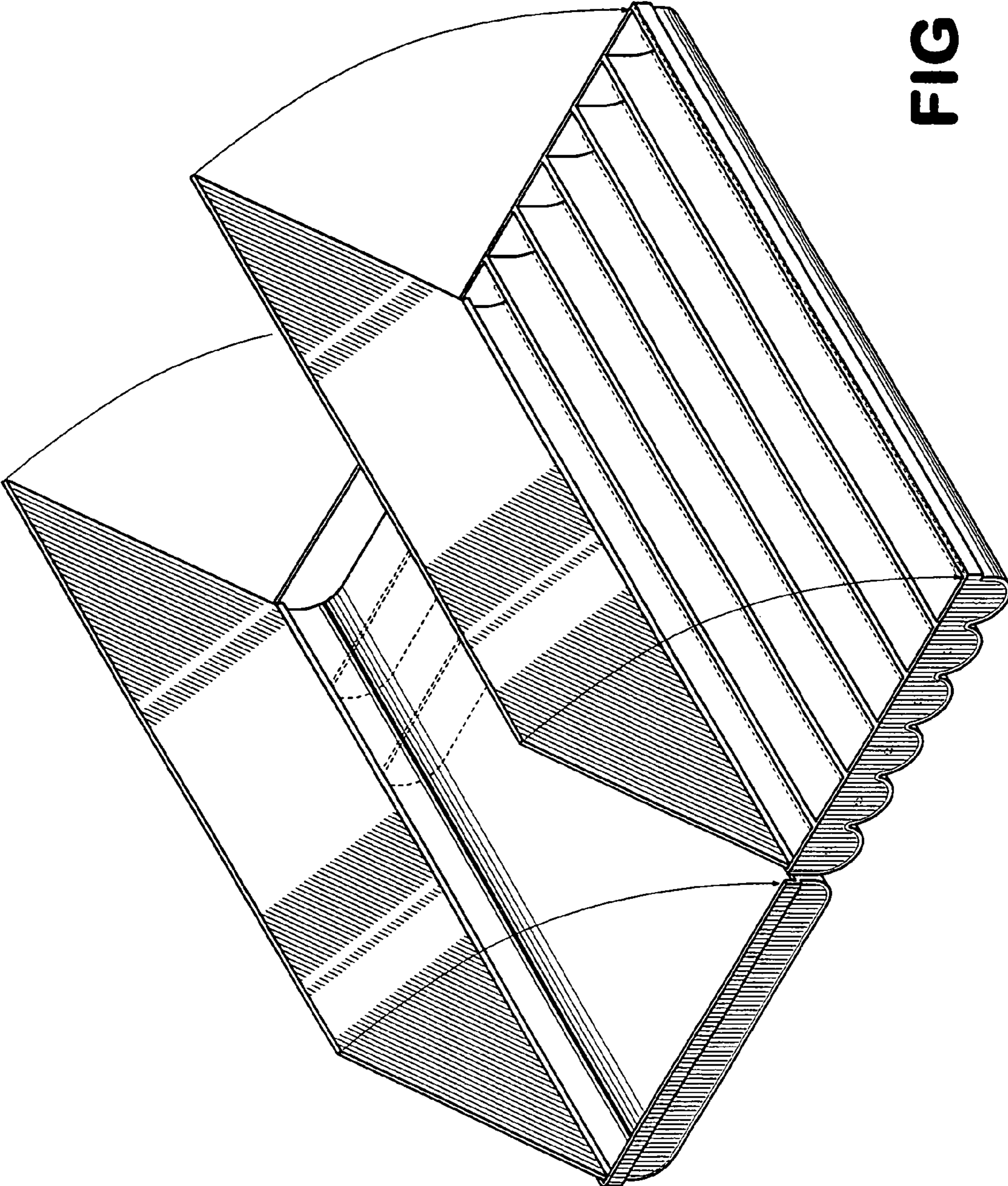

FIG 7

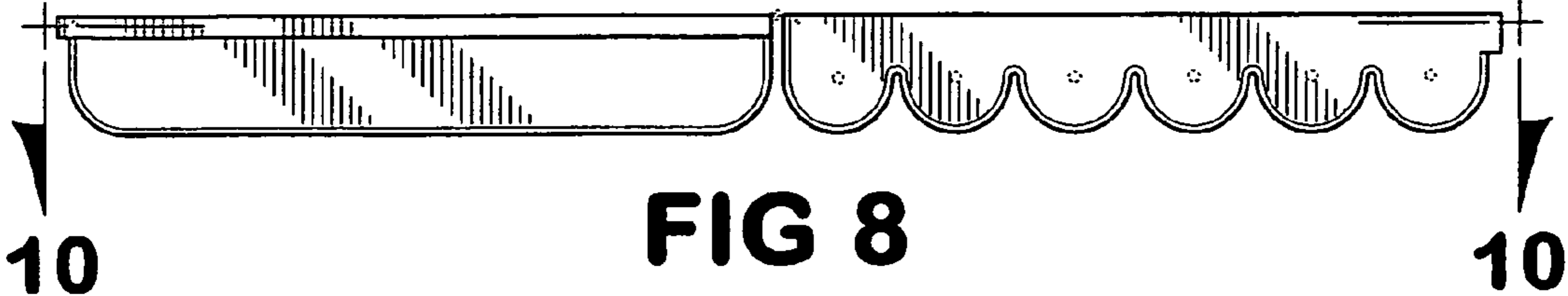

FIG 8

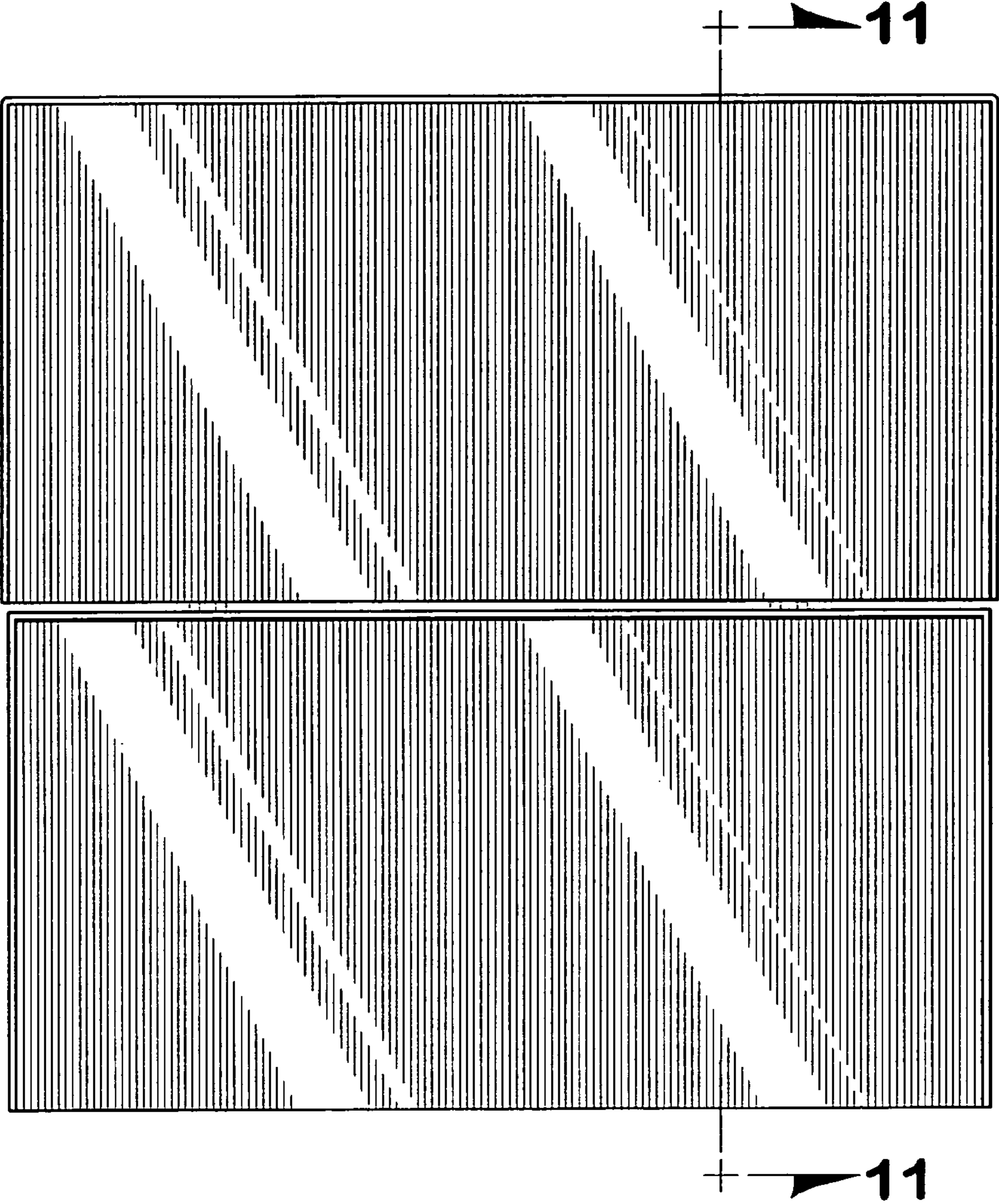

FIG 9

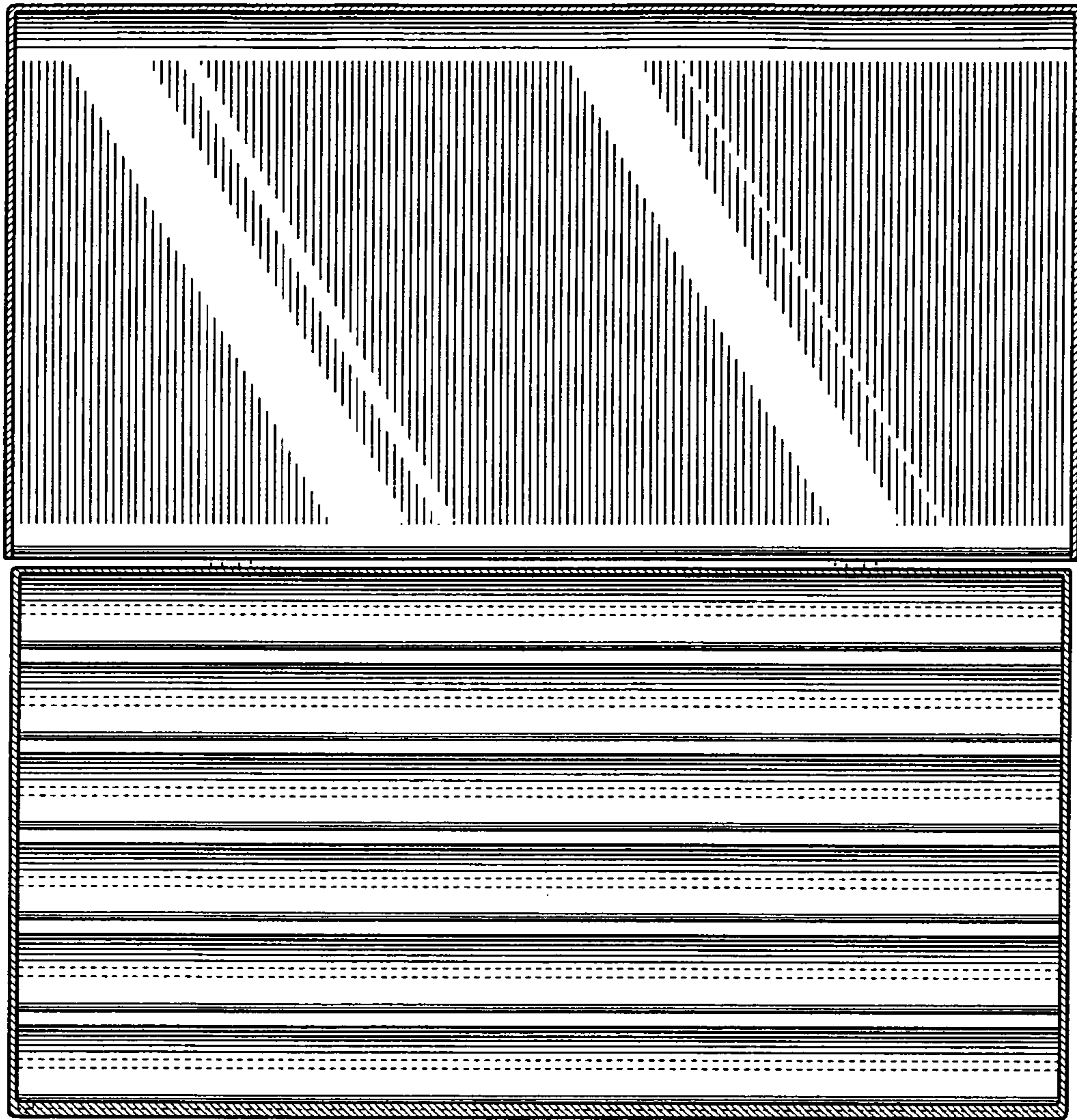

FIG 10

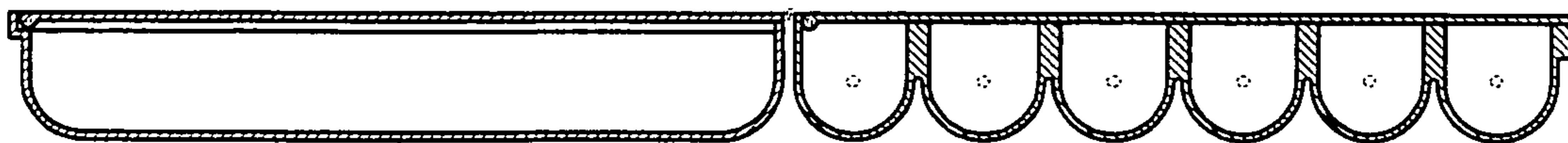

FIG 11