



US00D579628S

(12) **United States Design Patent**
Wiens

(10) **Patent No.:** **US D579,628 S**
(45) **Date of Patent:** **** Nov. 4, 2008**

(54) **ADJUSTABLE JOCK CUP POUCH**

(57) **CLAIM**

(76) **Inventor:** **Joel J. Wiens**, 10570 202nd St. West,
Lakeville, MN (US) 55044

The ornamental design for a adjustable jock cup pouch, as shown and described.

(**) **Term:** **14 Years**

DESCRIPTION

(21) **Appl. No.:** **29/286,280**

(22) **Filed:** **May 1, 2007**

(51) **LOC (8) Cl.** **24-04**

(52) **U.S. Cl.** **D2/711; D29/101.5**

(58) **Field of Classification Search** D2/711,
D2/700; 2/1, 46, 67, 400, 403, 406, 466;
602/67, 70; D29/101.5, 100, 122; 128/891
See application file for complete search history.

FIG. 1 is a front perspective view of an adjustable jock cup pouch, showing my new design;

FIG. 2 is a front elevational view thereof;

FIG. 3 is a top plan view thereof;

FIG. 4 is a bottom plan view thereof;

FIG. 5 is a left side elevational view thereof;

FIG. 6 is a right side elevational view thereof;

FIG. 7 is a rear elevational view thereof;

FIG. 8 is a cross-sectional view taken along the line 8—8 of FIG. 2;

FIG. 9 is a cross-sectional view taken along the line 9—9 of FIG. 2;

FIG. 10 is a cross-sectional view taken along the line 10—10 of FIG. 2; and,

FIG. 11 is a cross-sectional view taken along the line 11—11 of FIG. 2.

The dashed lines shown in the drawings represents a stitching line.

(56) **References Cited**

U.S. PATENT DOCUMENTS

5,237,706	A *	8/1993	Nalbandian	2/403
5,243,974	A *	9/1993	Allen	607/108
5,547,466	A *	8/1996	McRoberts et al.	602/70
D382,089	S *	8/1997	Olson	D2/711
D395,735	S *	7/1998	Paramore	D2/711
D503,511	S *	4/2005	Glisson et al.	D2/711
D516,253	S *	2/2006	Wong	D29/101.5

* cited by examiner

Primary Examiner—Ian Simmons

Assistant Examiner—Anna J Burmeister

(74) *Attorney, Agent, or Firm*—Richard John Bartz

1 Claim, 4 Drawing Sheets

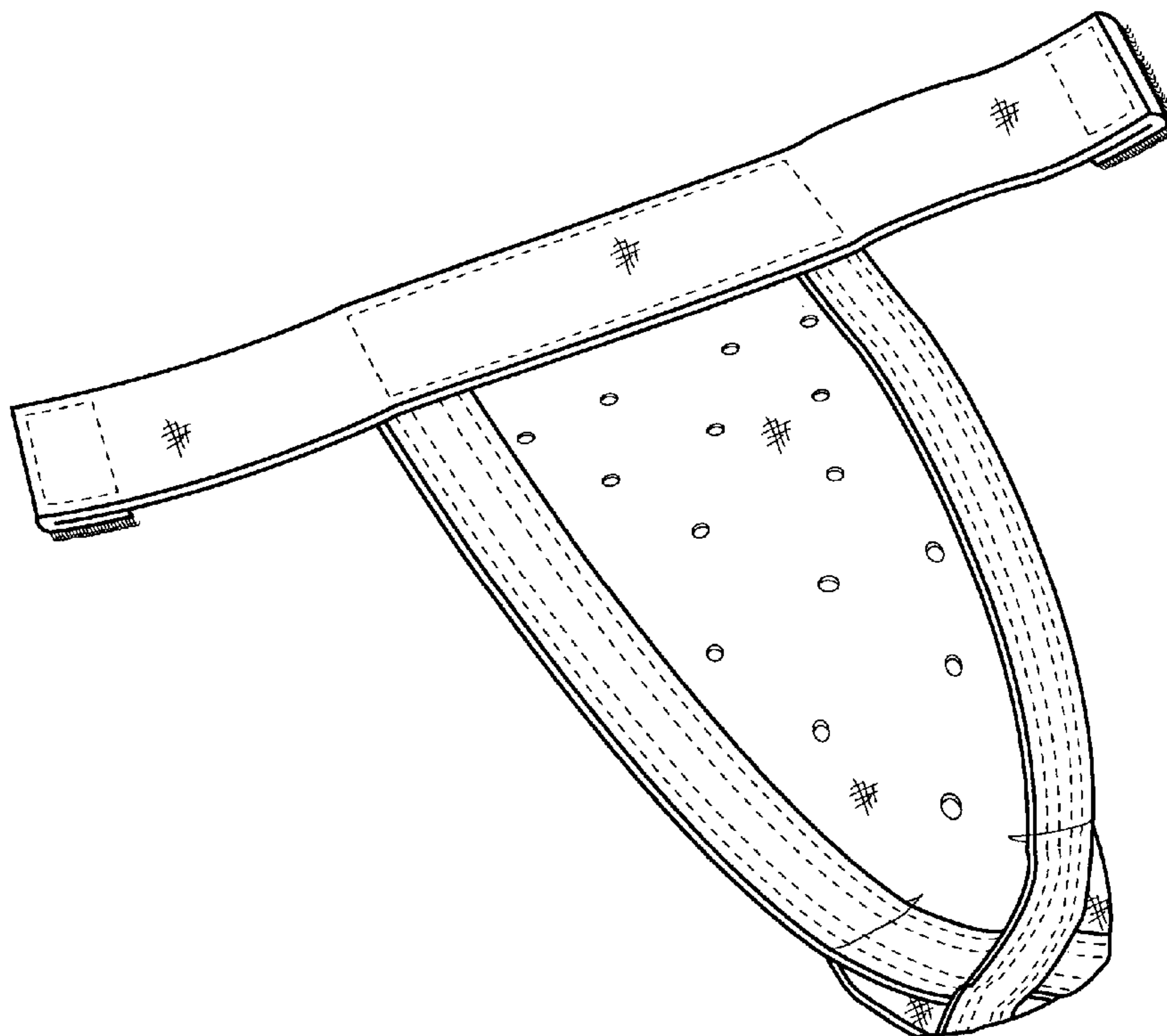

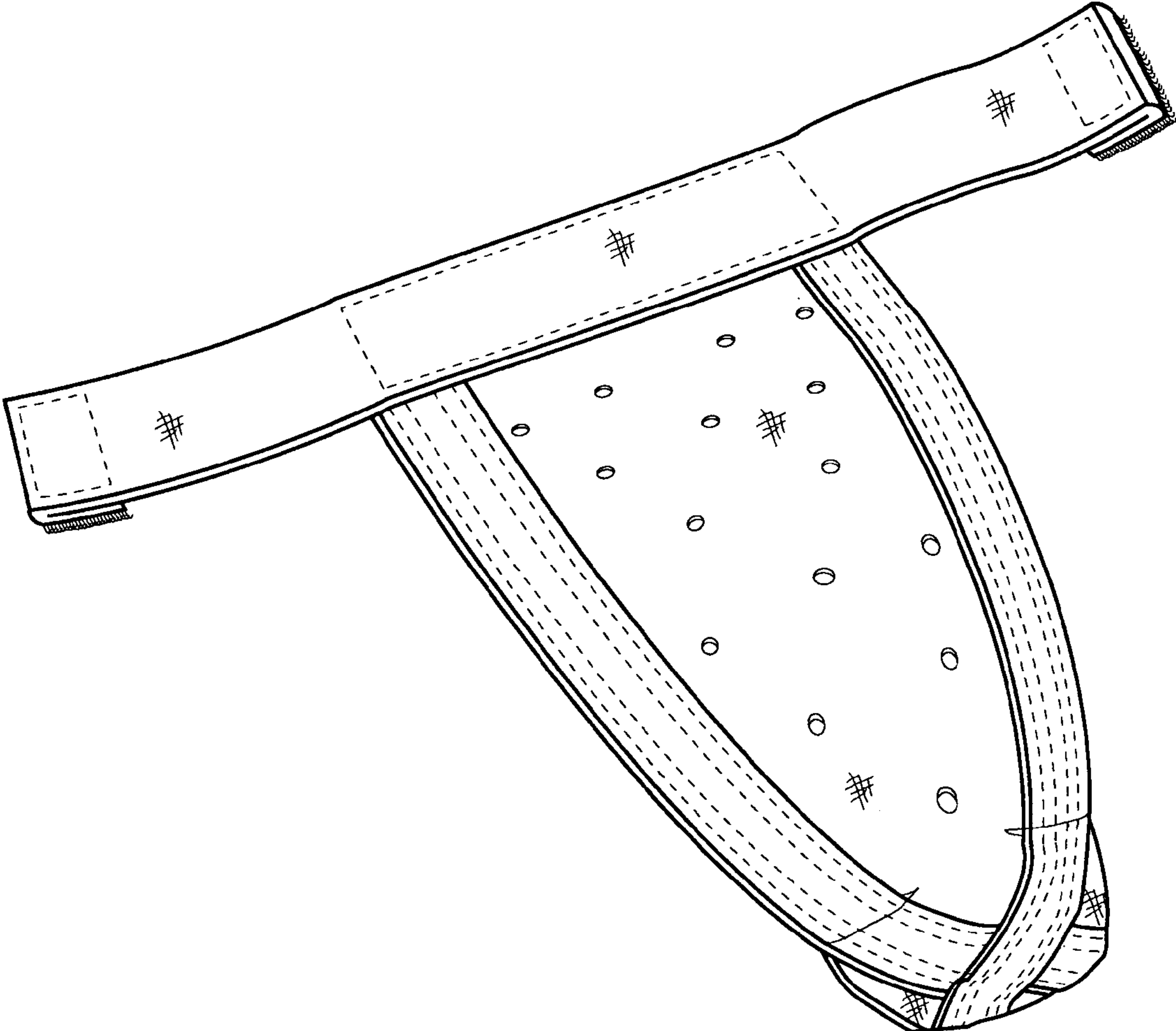

FIG. 1

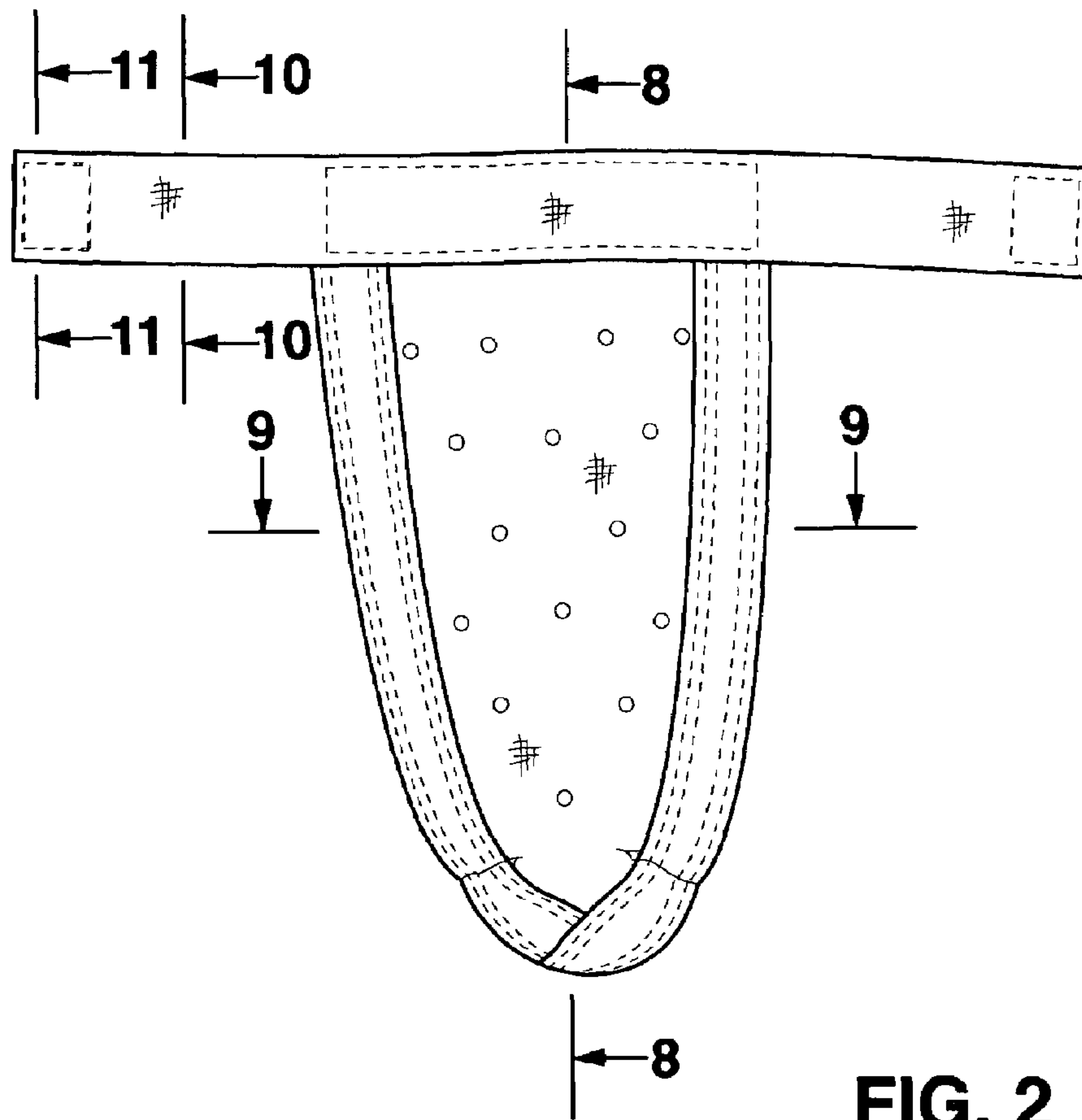

FIG. 2

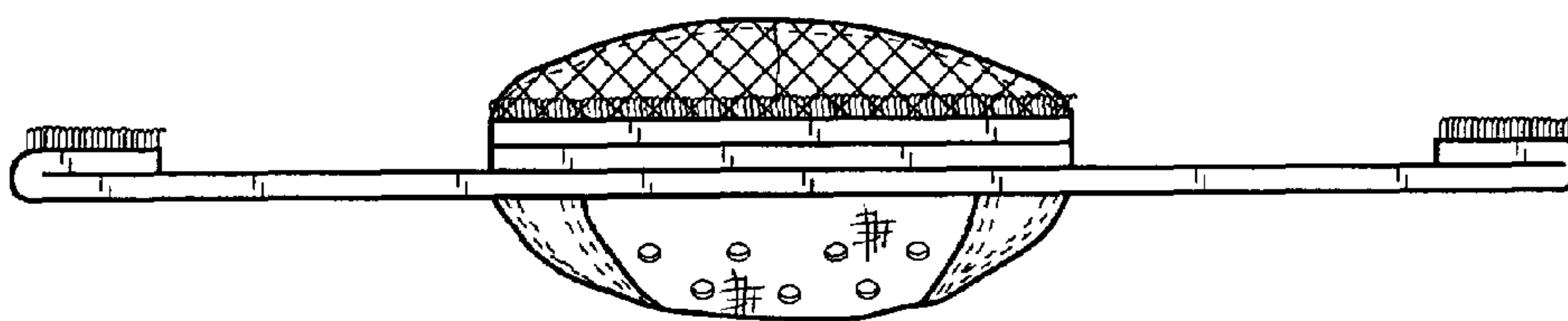

FIG. 3

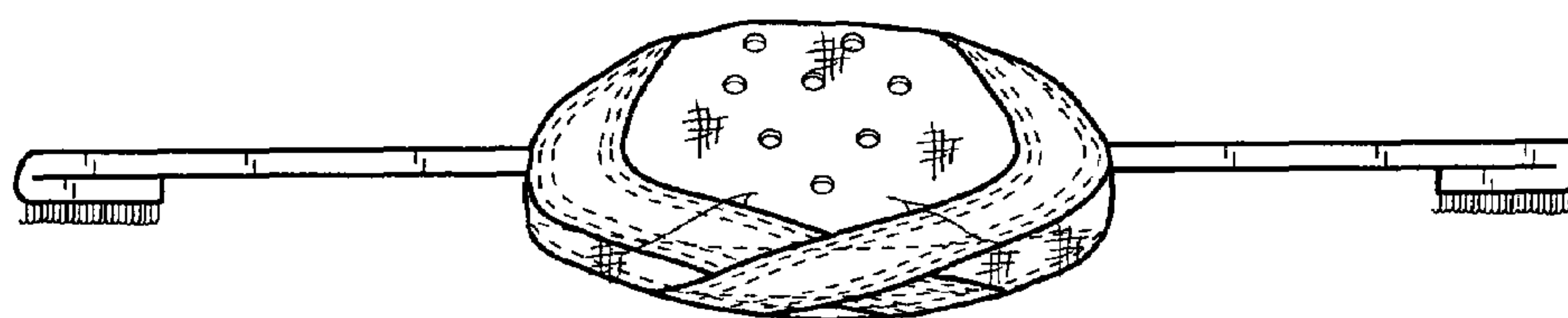

FIG. 4

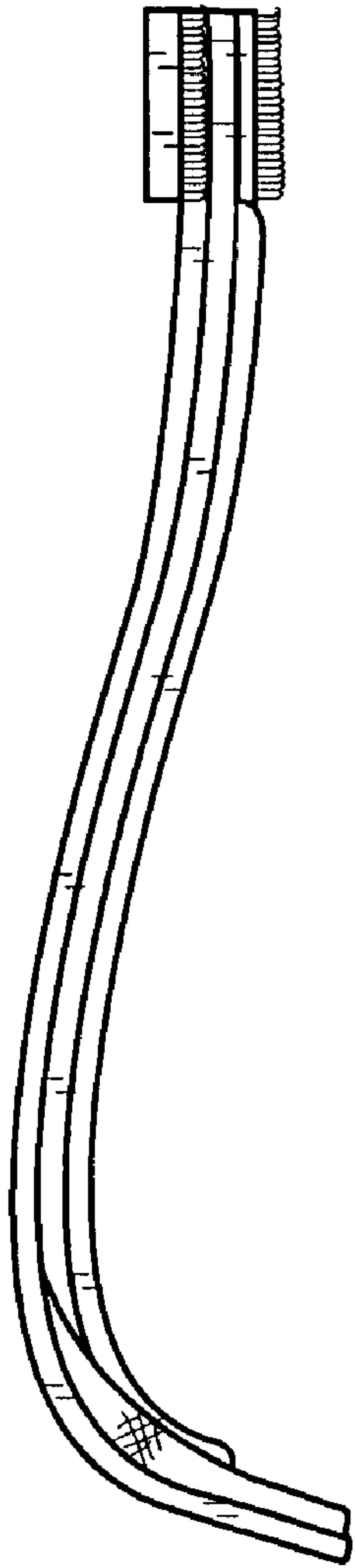

FIG. 5

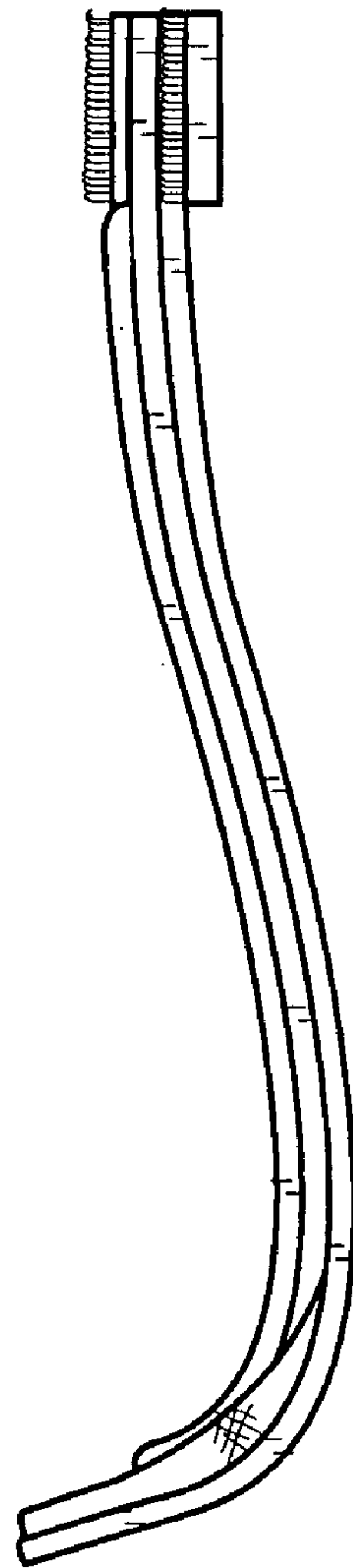

FIG. 6

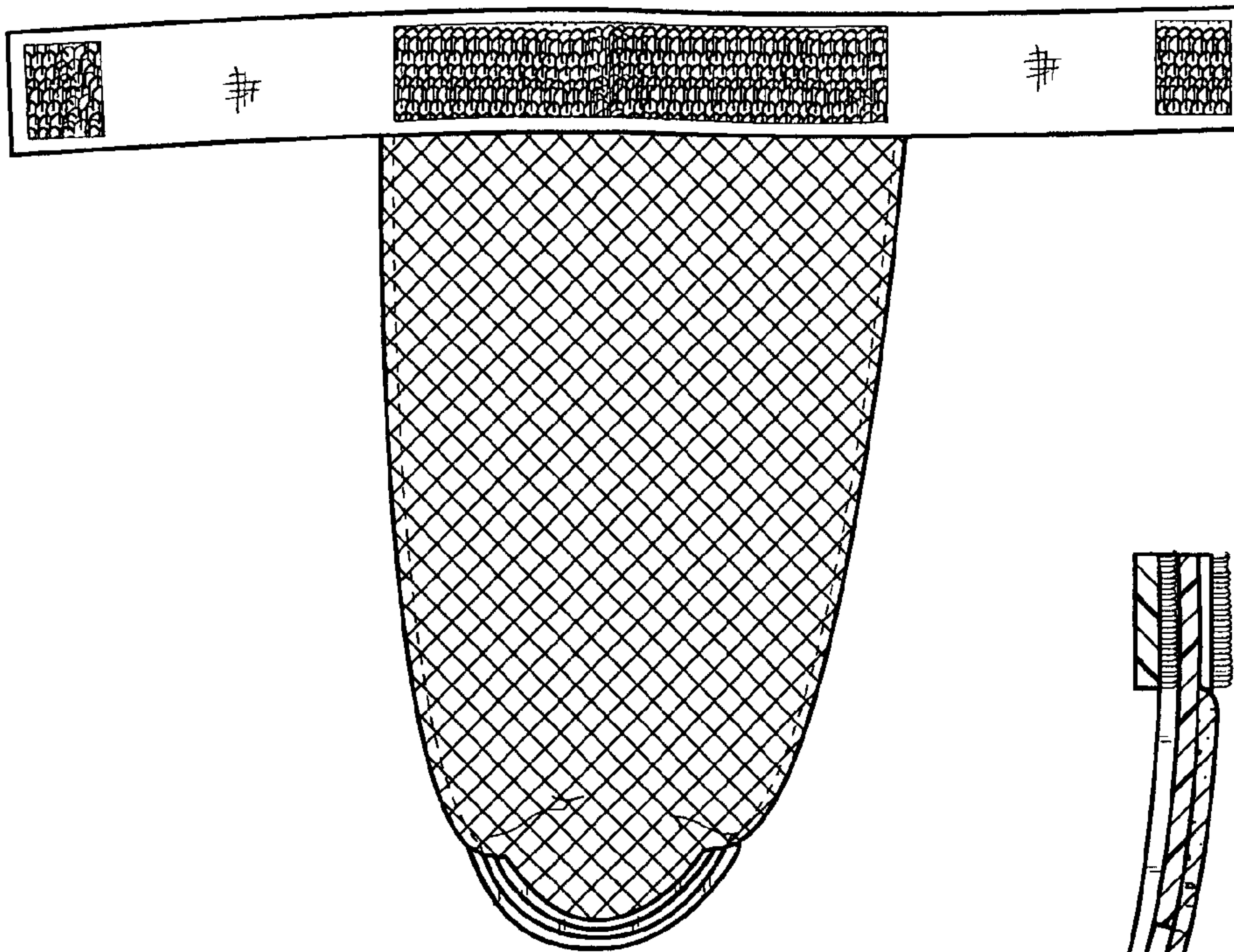

FIG. 7

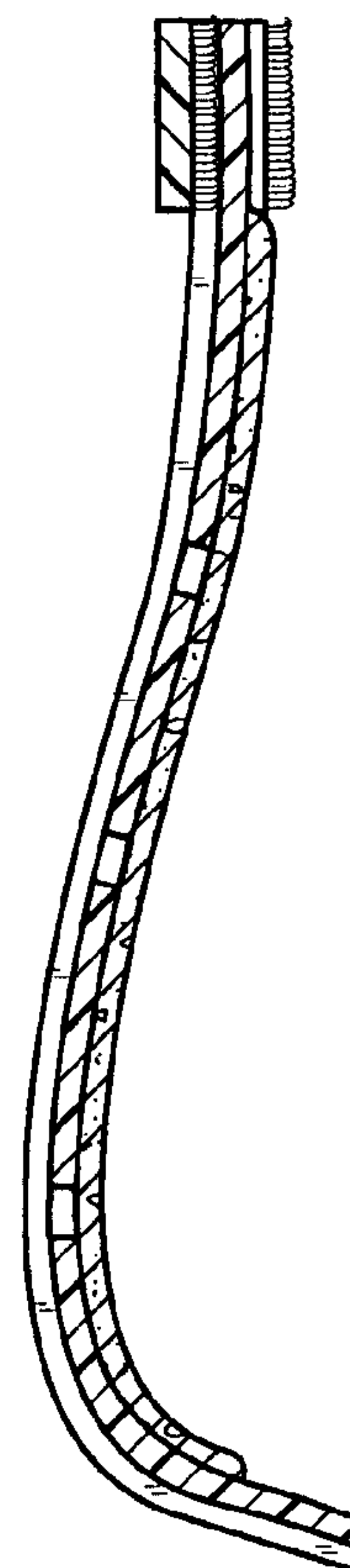

FIG. 8

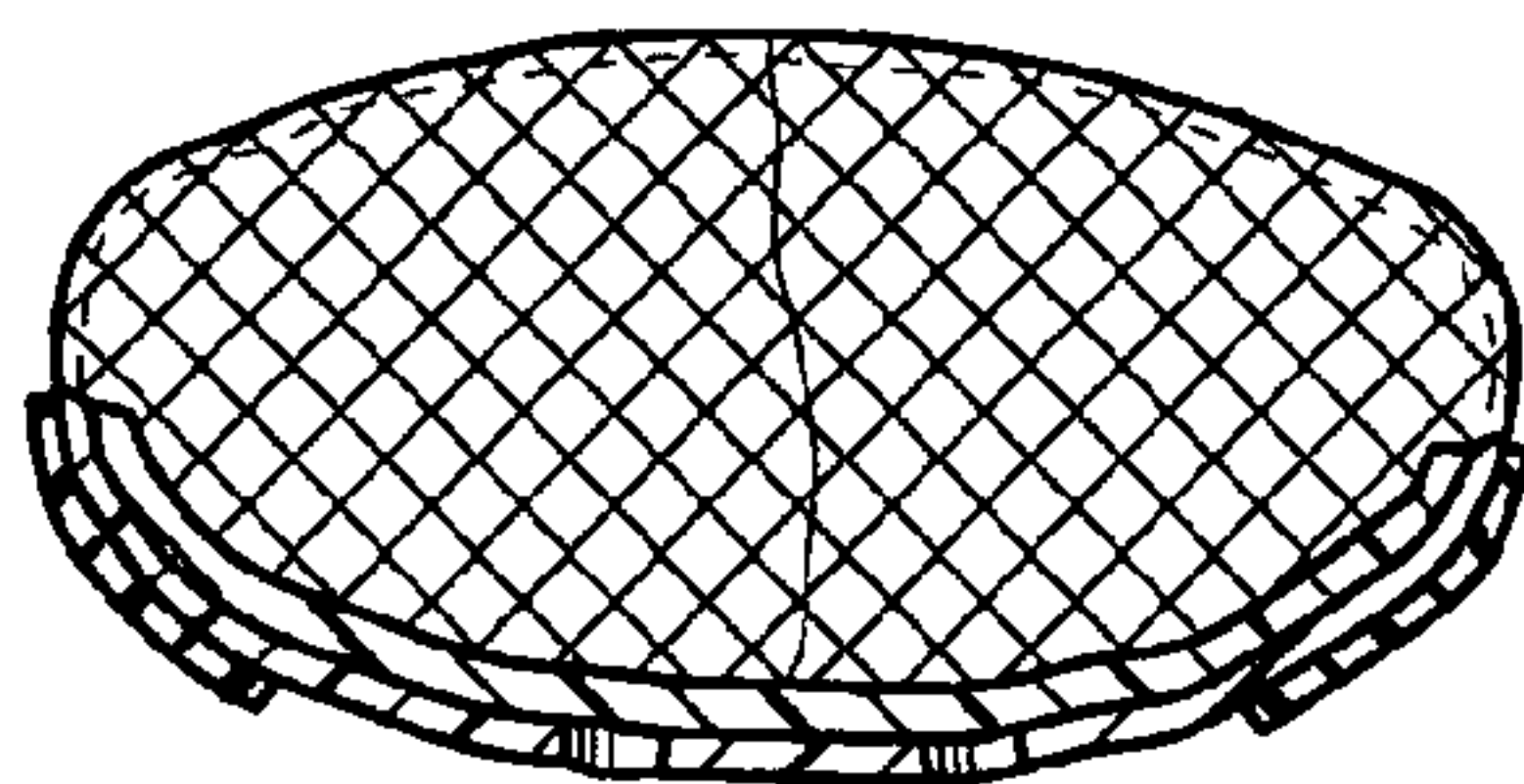

FIG. 9



FIG. 10

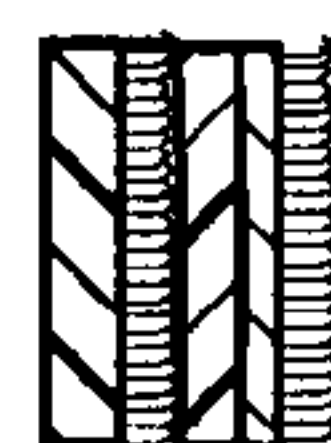

FIG. 11