



US00D579509S

(12) **United States Design Patent**
Nutting

(10) **Patent No.:** **US D579,509 S**
(45) **Date of Patent:** **** Oct. 28, 2008**

(54) **PAIR OF ARTIFICIAL FANGS**

(76) Inventor: **Donald W. Nutting**, 1295 Ithaca Dr.,
Boulder, CO (US) 80305

(**) Term: **14 Years**

(21) Appl. No.: **29/277,290**

(22) Filed: **Feb. 20, 2007**

(51) **LOC (8) Cl.** **21-03**

(52) **U.S. Cl.** **D21/812**

(58) **Field of Classification Search** D21/814;
D24/156; 433/218, 219, 202.3, 223, 322.1,
433/226, 204, 206, 212.1; 472/70; 66/500

See application file for complete search history.

(56) **References Cited**

U.S. PATENT DOCUMENTS

1,379,063	A	5/1921	Van Allen	
2,057,341	A	10/1936	Morgan	
2,527,094	A *	10/1950	Goldfarb 472/70
3,558,540	A	1/1971	Molnar	
3,793,728	A	2/1974	Corbineau	
4,015,332	A	4/1977	Manne	
4,206,545	A	6/1980	Lard	
4,251,215	A	2/1981	May et al.	
4,430,061	A	2/1984	Webb et al.	
4,678,435	A	7/1987	Long	
4,738,622	A	4/1988	Kawahara et al.	
5,102,337	A	4/1992	Soroca	
5,324,198	A	6/1994	Hazen	
5,403,186	A	4/1995	Ginsburg	
5,547,381	A	8/1996	Nutting	
5,569,036	A	10/1996	Goldiner et al.	
5,775,909	A *	7/1998	Langer 433/218
D463,860	S *	10/2002	Goldiner et al. D24/156
D475,429	S *	6/2003	Liao D21/812

FOREIGN PATENT DOCUMENTS

WO 9103210 3/1991

OTHER PUBLICATIONS

- Generik Ink, Inc. Why Not Party? Horror Film Make-Up instruction sheet, 1988.
- Fangtastics fang instruction sheet.
- Scarecrow Custom Fangs instruction sheet.
- #262 Cheap Scarecrow Fang photographs.
- #373 Original Fangtastics Fang photographs.
- #449 New Fangtastics Fang photographs.
- #386 Professional Fangtastics Fang photographs.
- #419 New Bloody Mary Fang photographs.
- #224 Norben Fang photographs.
- #421 Hot Topic Fang photographs.
- #433 Fun World Fang photographs.
- #324 Old Foothills design Fang photographs.
- Fun World Tooth Cap Drawing.

* cited by examiner

Primary Examiner—Mitchell I Siegel
(74) *Attorney, Agent, or Firm*—Brian D. Smith, P.C.

(57) **CLAIM**

The ornamental design for the pair of artificial fangs, as shown and described.

DESCRIPTION

FIG. 1 is a right-side perspective view of the right artificial fang of a pair of artificial fangs, showing my new design;
 FIG. 2 is a front view of the design of FIG. 1;
 FIG. 3 is a rear view of the design of FIG. 1;
 FIG. 4 is a left side view of the design of FIG. 1;
 FIG. 5 is a right side view of the design of FIG. 1;
 FIG. 6 is a top plan view of the design of FIG. 1; and,
 FIG. 7 is a bottom plan view of the design of FIG. 1.
 The left artificial fang of the pair of artificial fangs being the mirror image of the artificial fang depicted in FIGS. 1–7.

1 Claim, 2 Drawing Sheets

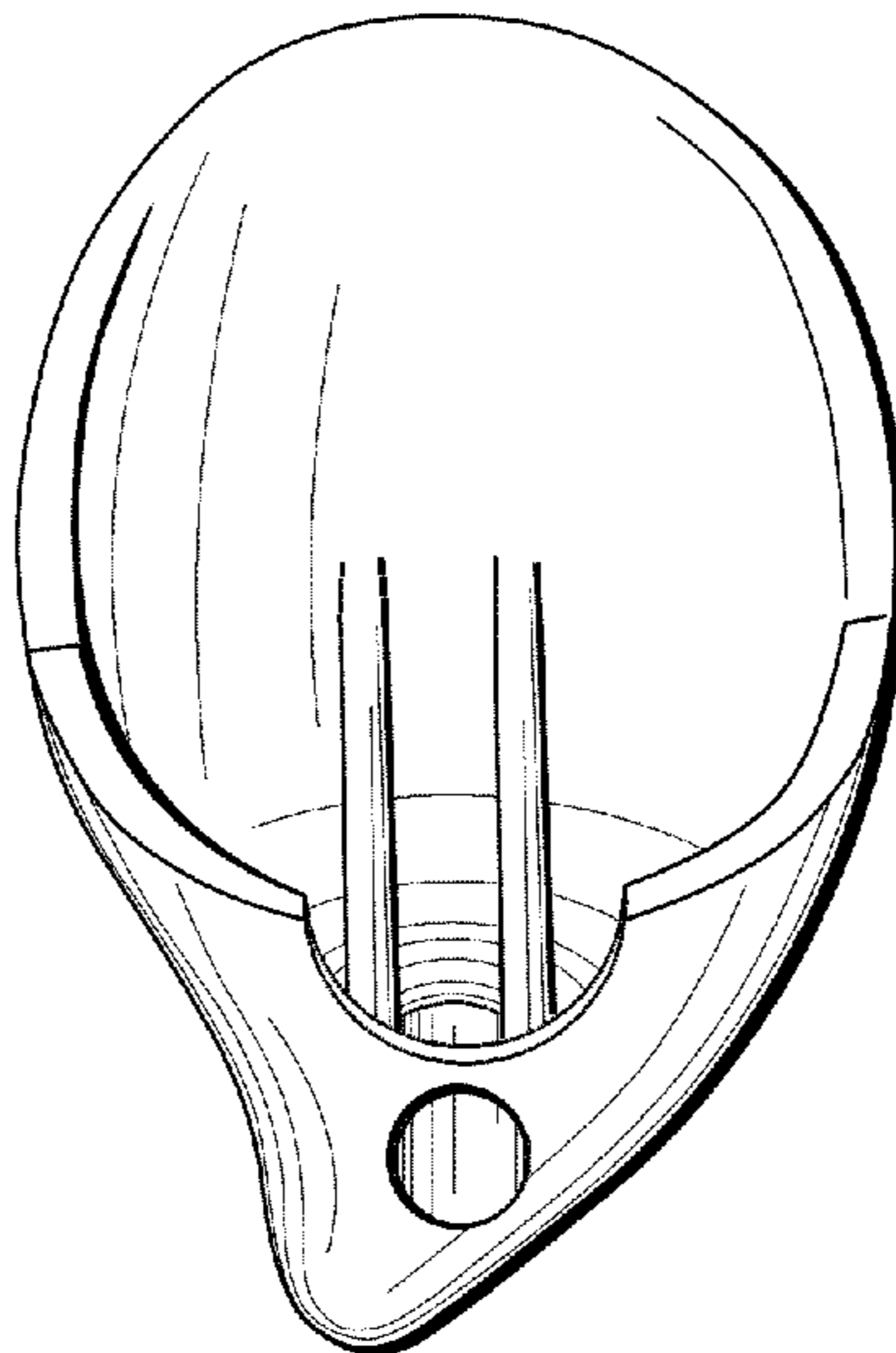

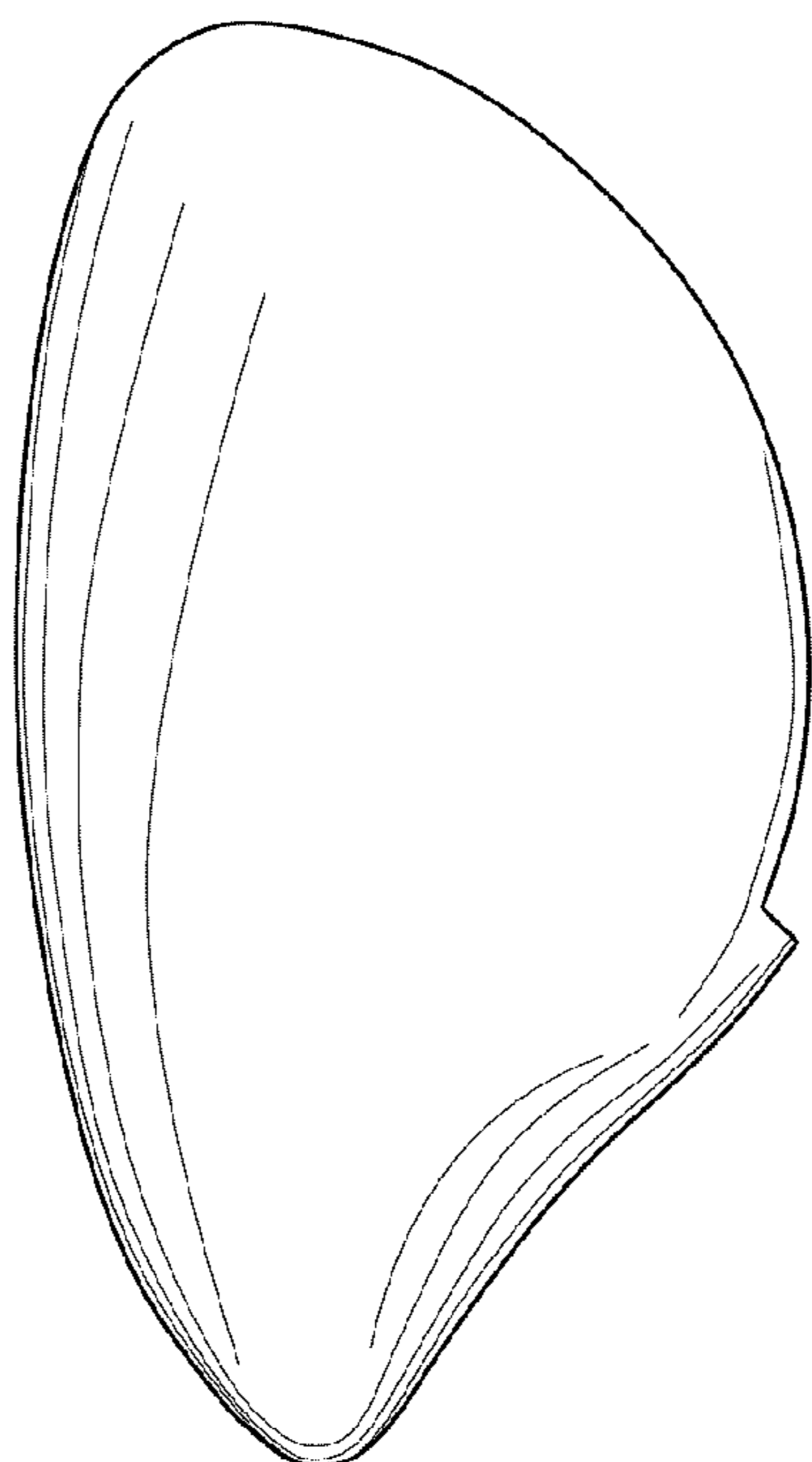

FIG. 1

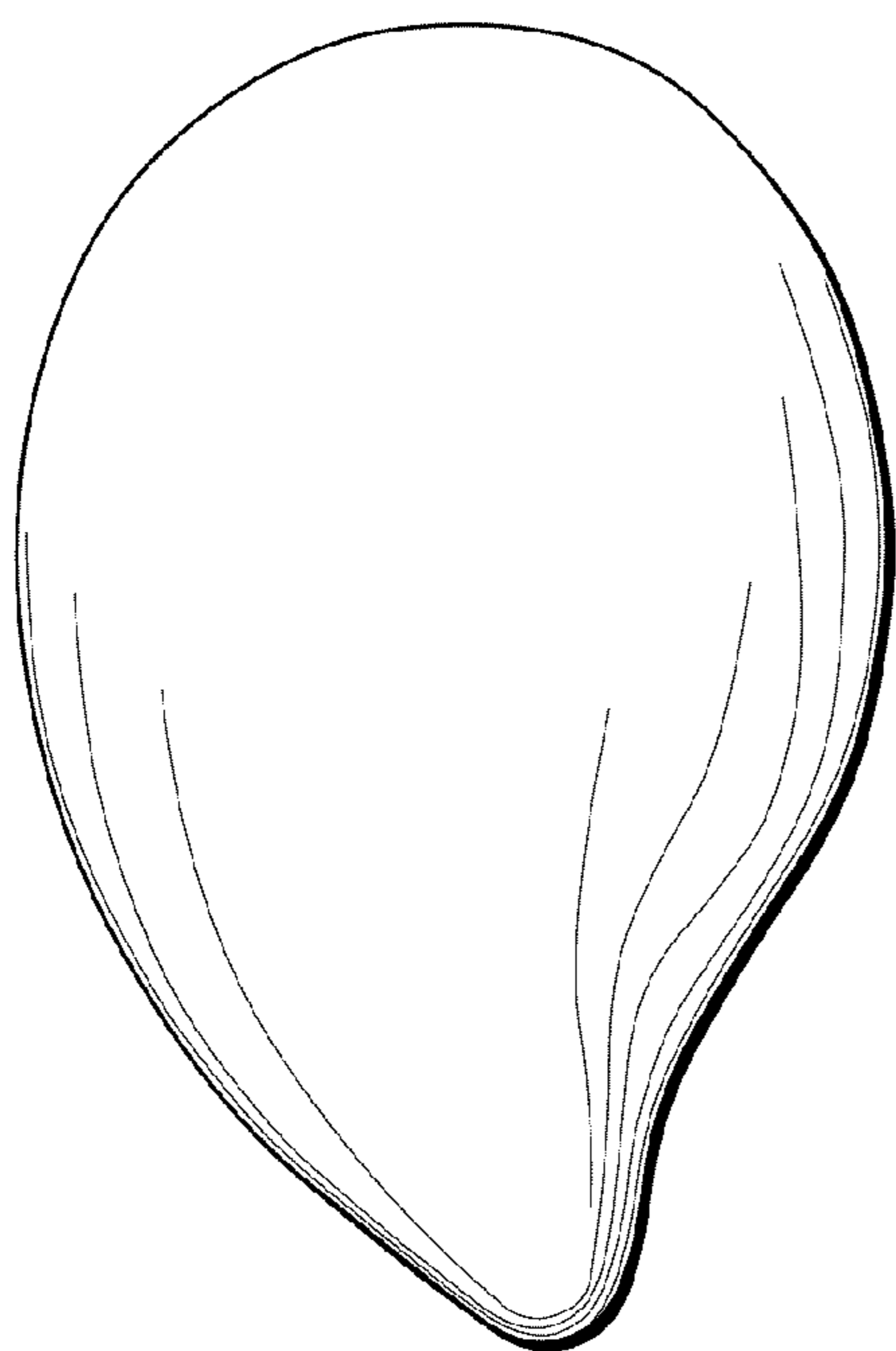

FIG. 2

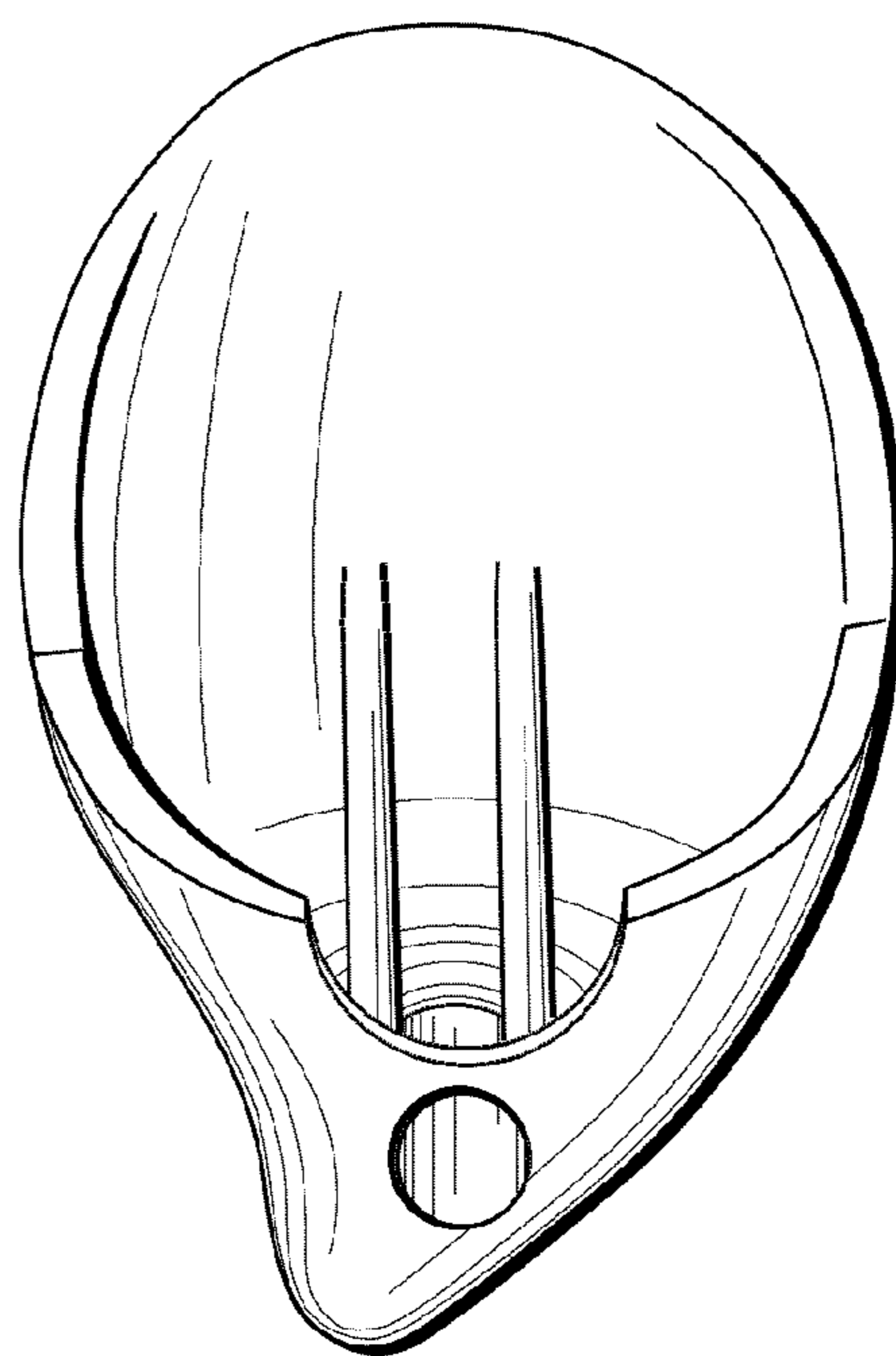

FIG. 3

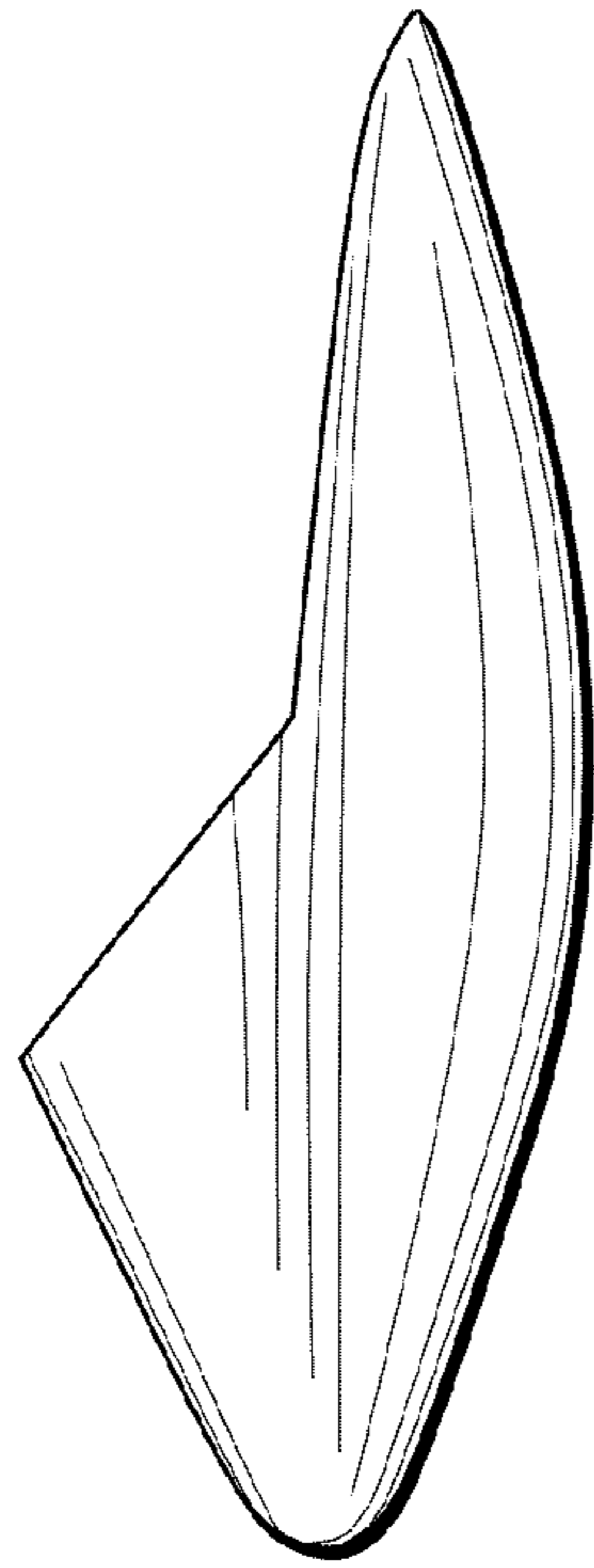

FIG. 4



FIG. 5

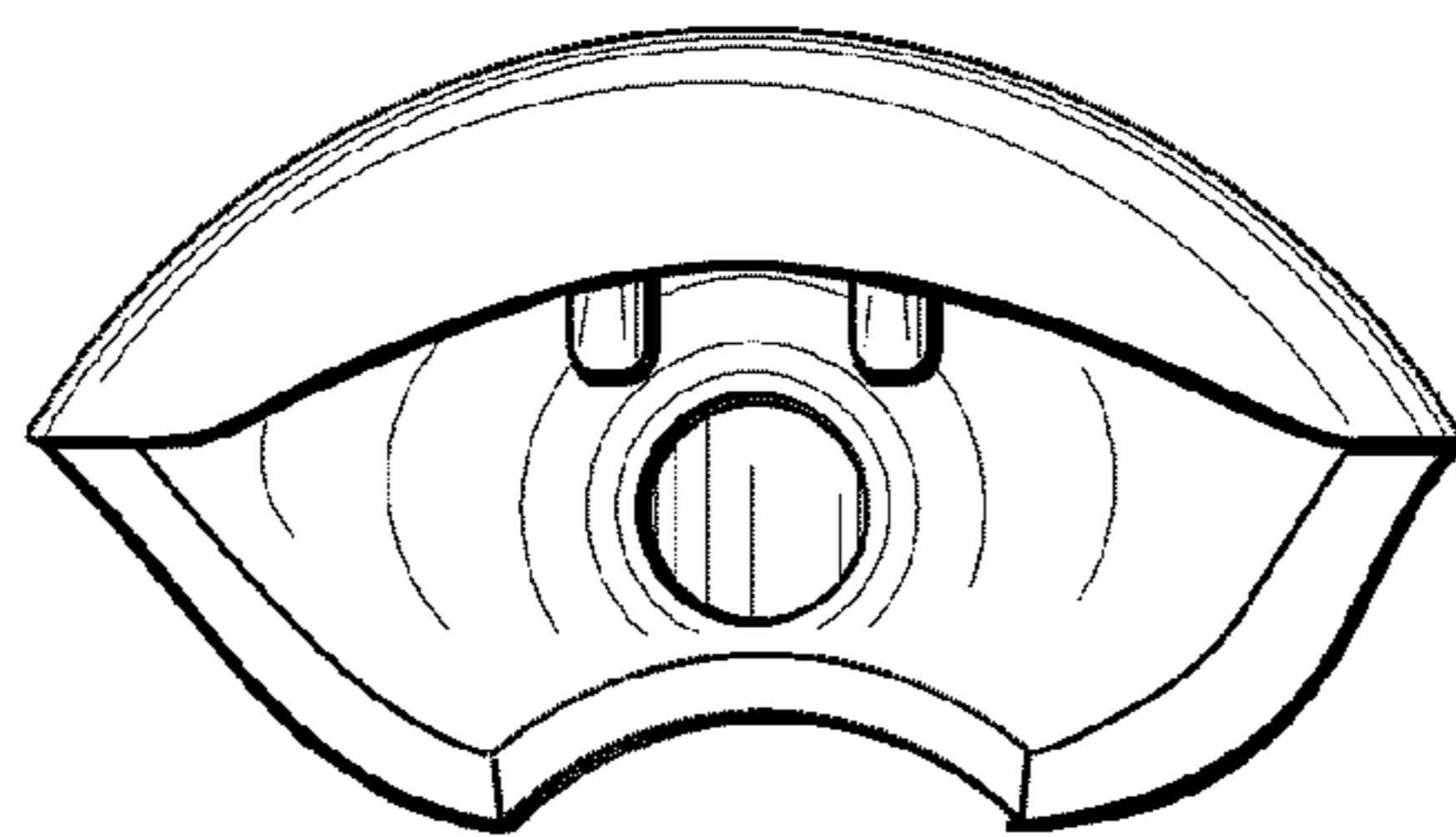

FIG. 6

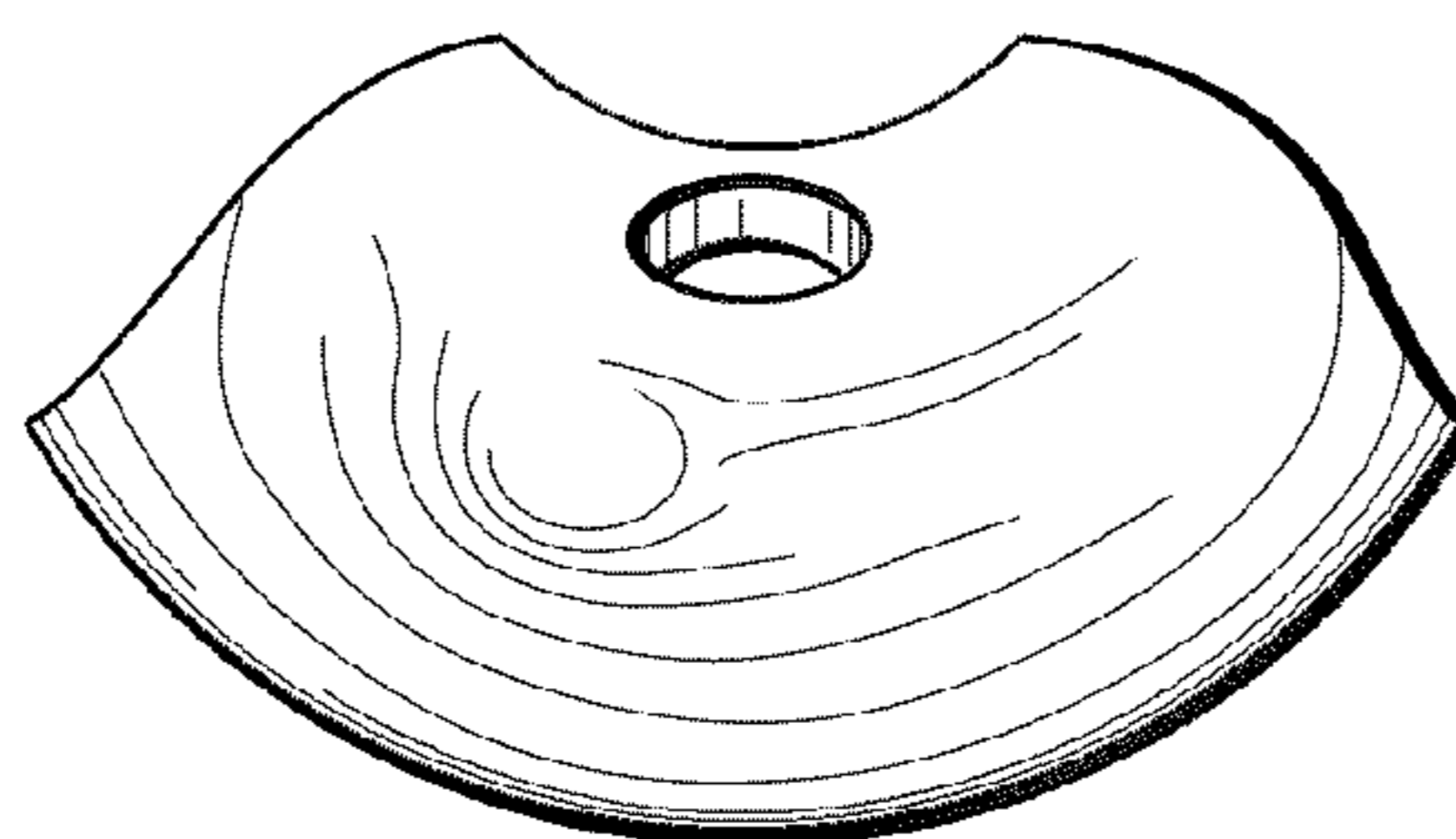

FIG. 7