



US00D579438S

(12) **United States Design Patent**
Kim et al.

(10) **Patent No.:** **US D579,438 S**
(45) **Date of Patent:** **** Oct. 28, 2008**

(54) **CELLULAR PHONE**

(75) Inventors: **Dong-Kyun Kim**, Gyeonggi-do (KR);
Joon-Suh Kim, Gyeonggi-do (KR);
Gee-Hong Yoon, Gyeonggi-do (KR)

(73) Assignee: **Samsung Electronics Co., Ltd.**,
Suwon-Si (KR)

(**) Term: **14 Years**

(21) Appl. No.: **29/290,949**

(22) Filed: **Feb. 1, 2008**

(51) **LOC (8) Cl.** **14-03**

(52) **U.S. Cl.** **D14/138**

(58) **Field of Classification Search** D14/138,
D14/496, 341-347; 455/575.3, 575.1
See application file for complete search history.

(56) **References Cited**

U.S. PATENT DOCUMENTS

D489,344 S *	5/2004	Lee et al.	D14/138
6,731,959 B1 *	5/2004	Kumagai et al.	455/575.3
D496,347 S *	9/2004	Choi et al.	D14/191
D498,468 S *	11/2004	Seo	D14/138
D501,839 S *	2/2005	Lee et al.	D14/138
D502,161 S *	2/2005	Kim et al.	D14/138
D512,394 S *	12/2005	Kim et al.	D14/138
D517,517 S *	3/2006	Li et al.	D14/138
D518,809 S *	4/2006	Cho	D14/138
D519,098 S *	4/2006	Han et al.	D14/138
D535,273 S *	1/2007	Baik et al.	D14/138
D535,633 S *	1/2007	Cho	D14/138
D535,965 S *	1/2007	Baik et al.	D14/138
D536,323 S *	2/2007	Oh et al.	D14/138
D557,230 S *	12/2007	Kim et al.	D14/138
D558,711 S *	1/2008	Moon et al.	D14/138
D558,722 S *	1/2008	Kim et al.	D14/138
D560,198 S *	1/2008	Kim et al.	D14/138
D560,638 S *	1/2008	Kim et al.	D14/138
D566,676 S *	4/2008	Kim et al.	D14/138
D569,361 S *	5/2008	Park	D14/138
D569,832 S *	5/2008	Lee et al.	D14/138

D571,342 S *	6/2008	Cho et al.	D14/138
D571,343 S *	6/2008	Cha et al.	D14/138
2002/0032010 A1 *	3/2002	Okuda et al.	455/90
2005/0107117 A1 *	5/2005	Makino	455/556.1

OTHER PUBLICATIONS

Motorola V220 telephone, announced 4th quarter 2003, [online], [site visited Jul. 7, 2008]. Available from Internet ,<URL: <http://www.gsmarena.com>>.*

LG F2250 telephone, announced 3rd quarter 2005, [online], [site visited Jul. 7, 2008]. Available from Internet ,<URL: <http://www.gsmarena.com>>.*

Alcatel OT-E227 telephone, announced Feb. 2007, [online], [site visited Jul. 7, 2008]. Available from Internet ,<URL: <http://www.gsmarena.com>>.*

Philips Xenium 9@9r telephone, announced Apr. 2007, [online], [site visited Jul. 7, 2008]. Available from Internet ,<URL: <http://www.gsmarena.com>>.*

(Continued)

Primary Examiner—Jeffrey D Asch

(74) *Attorney, Agent, or Firm*—Staas & Halsey LLP

(57) **CLAIM**

The ornamental design for a cellular phone, as shown and described.

DESCRIPTION

FIG. 1 is a perspective view of a cellular phone according to our new design;

FIG. 2 is a front elevational view thereof;

FIG. 3 is a rear elevational view thereof;

FIG. 4 is a left side elevational view thereof;

FIG. 5 is a right side elevational view thereof;

FIG. 6 is a top plan view thereof;

FIG. 7 is a bottom plan view thereof; and,

FIG. 8 is a perspective view of the cellular phone according to our new design in a state in which the cellular phone is open when used.

1 Claim, 6 Drawing Sheets

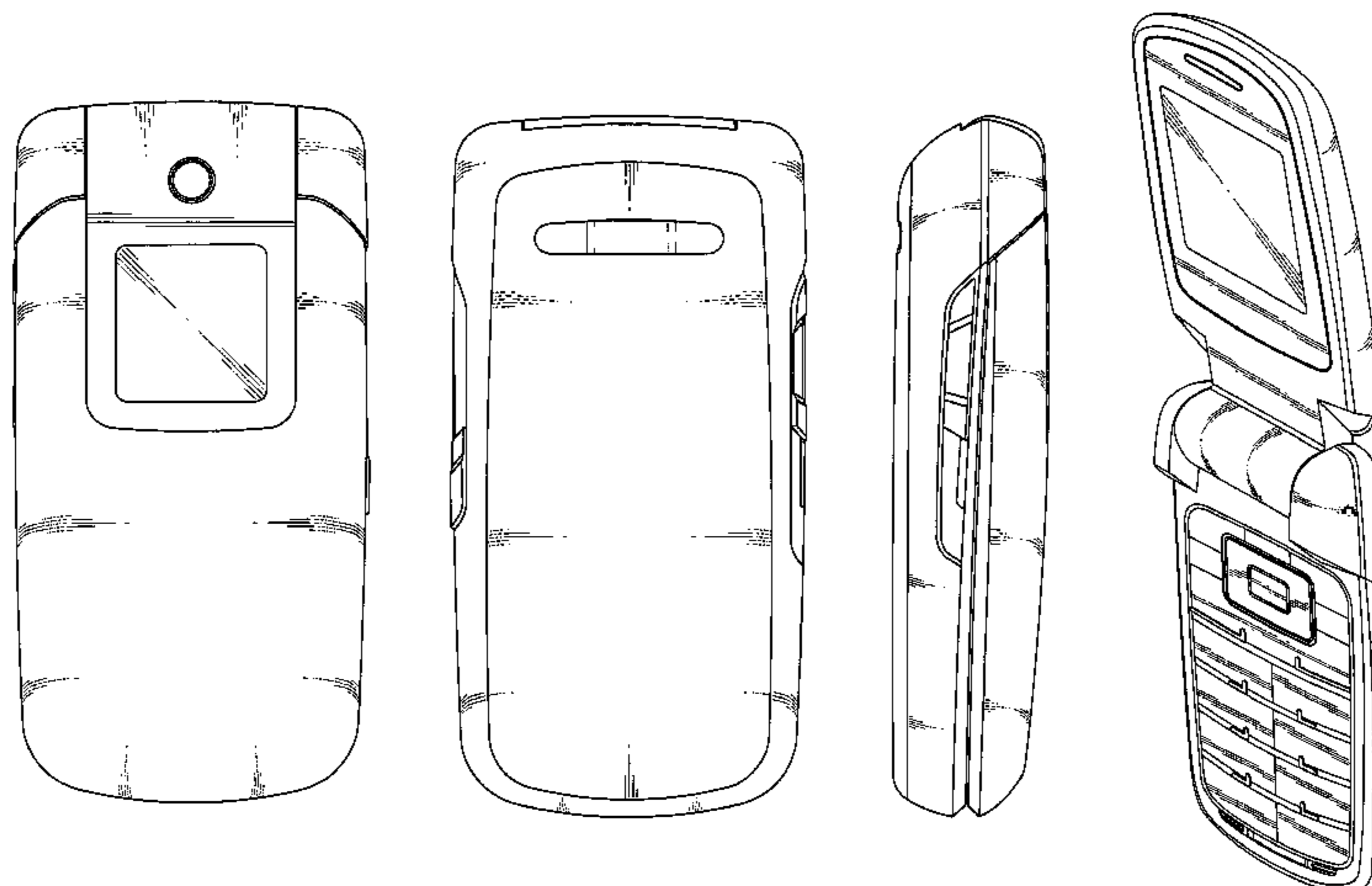

OTHER PUBLICATIONS

BenQ M350 telephone, announced 2nd quarter 2005, [online], [site visited Jul. 7, 2008]. Available from Internet ,<URL: <http://www.gsmarena.com>>.*

NEC N900iG telephone, announced 4th quarter 2004, [online], [site visited Jul. 7, 2008]. Available from Internet ,<URL: <http://www.gsmarena.com>>.*

* cited by examiner

FIG. 1

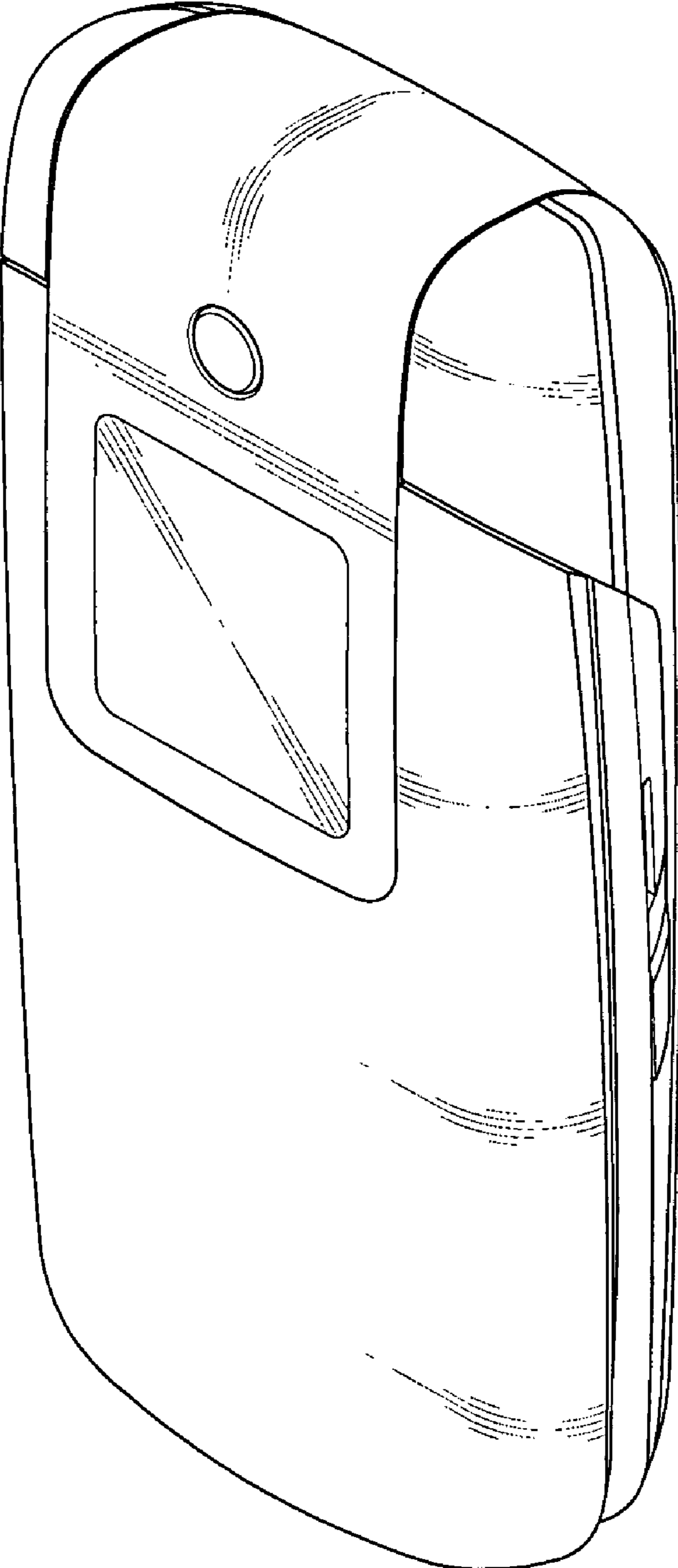

FIG.2

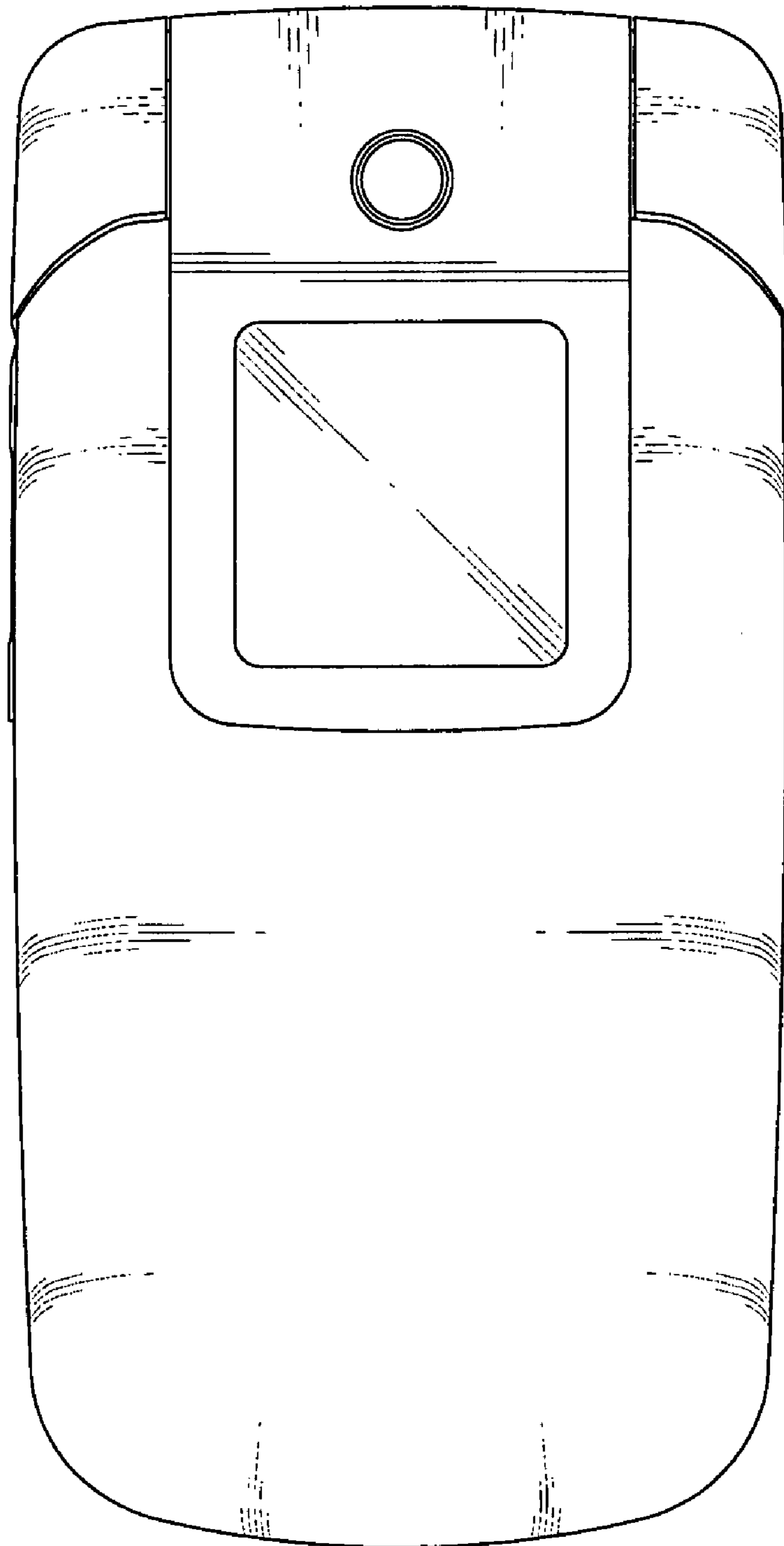

FIG.3

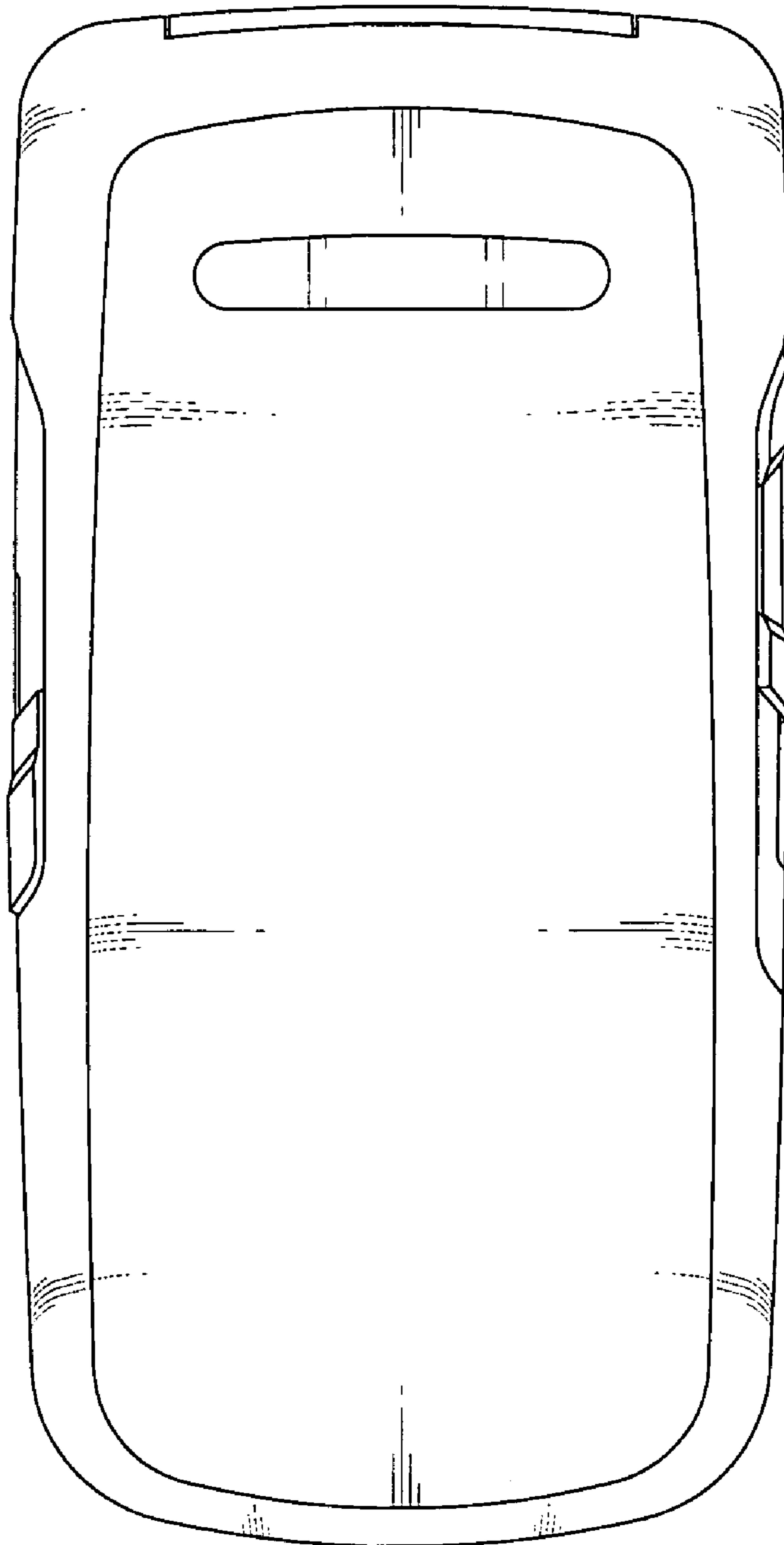

FIG.4

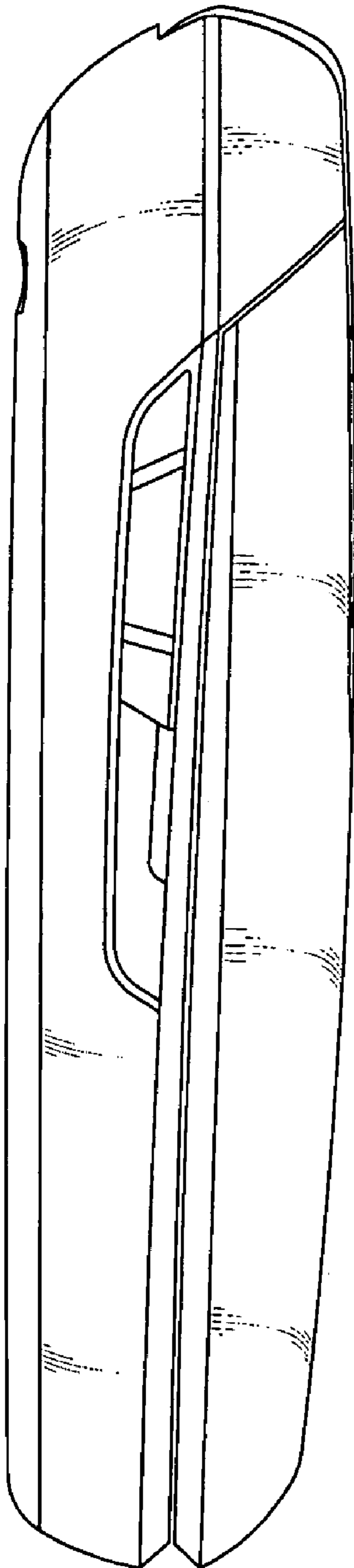

FIG.5

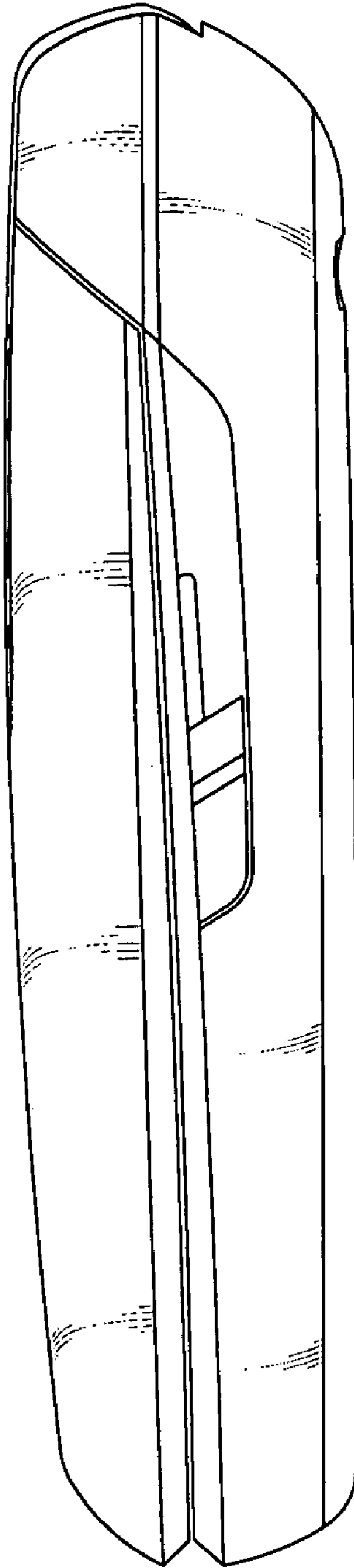

FIG.6

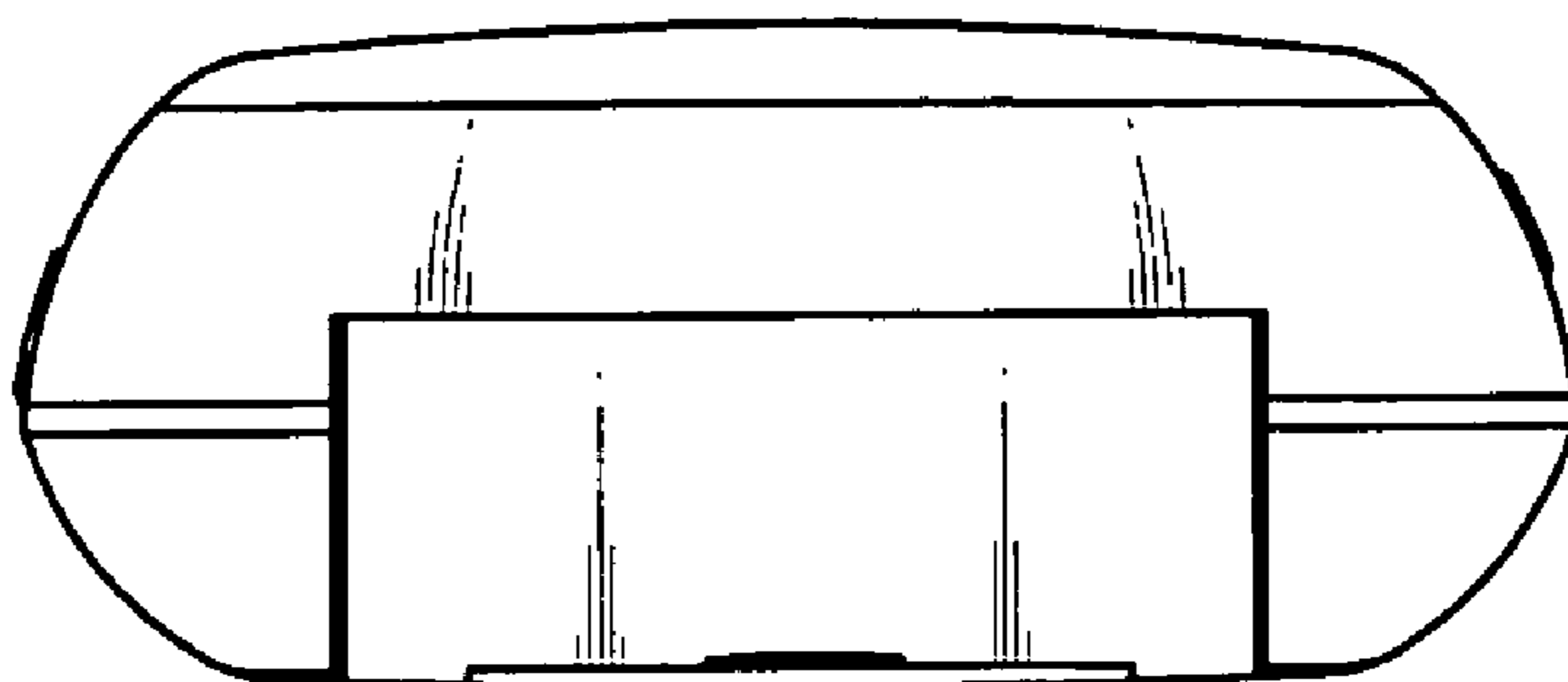

FIG.7

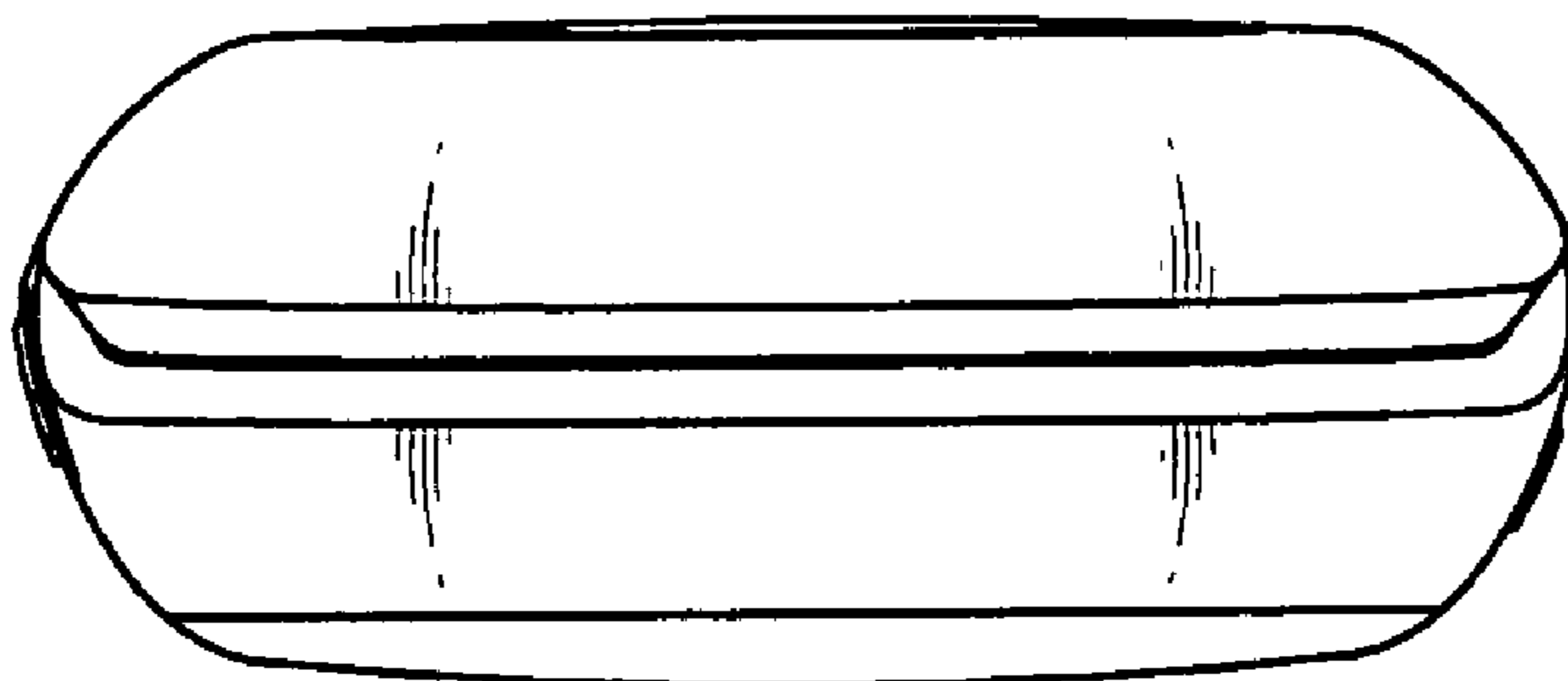

FIG.8

