



US00D579435S

(12) **United States Design Patent**
Han et al.

(10) **Patent No.:** **US D579,435 S**
(45) **Date of Patent:** **** Oct. 28, 2008**

(54) **MOBILE PHONE**

(75) Inventors: **Woo-Seung Han**, Seoul (KR);
Seog-Guen Kim, Seoul (KR); **Tae-Ho Kim**,
Yongin-si (KR); **Sung-Kyun Bai**, Seoul (KR);
Yun-Su Kim, Seoul (KR)

(73) Assignee: **Samsung Electronics Co., Ltd.**,
Suwon-Si (KR)

(**) Term: **14 Years**

(21) Appl. No.: **29/290,310**

(22) Filed: **Nov. 16, 2007**

(30) **Foreign Application Priority Data**

Aug. 10, 2007 (KR) 30-2007-0034500

(51) **LOC (8) Cl.** **14-03**

(52) **U.S. Cl.** **D14/138**

(58) **Field of Classification Search** D14/137,
D14/138, 147, 191, 218, 247-248, 341-347,
D14/496; D10/65, 78, 104; D13/168; D18/7;
455/556.1, 566, 575.1, 575.3; 345/169

See application file for complete search history.

(56) **References Cited**

U.S. PATENT DOCUMENTS

D483,032 S *	12/2003	Bertrand et al.	D14/248
D493,436 S *	7/2004	Okada et al.	D14/138
D509,206 S *	9/2005	Jang	D14/138
D509,813 S *	9/2005	Miyazawa et al.	D14/138
D513,512 S *	1/2006	Tsai	D14/496
7,068,259 B2 *	6/2006	Kim et al.	345/169
D526,222 S *	8/2006	Uehara	D10/65
D528,528 S *	9/2006	Moon et al.	D14/138
D529,886 S *	10/2006	Jang	D14/138
D530,295 S *	10/2006	Chung et al.	D14/138
D531,531 S *	11/2006	Chen	D10/65
D534,145 S *	12/2006	Lheem	D14/138
D534,517 S *	1/2007	Cho et al.	D14/138
D537,063 S *	2/2007	Kim et al.	D14/138
D541,777 S *	5/2007	Shimizu	D14/138
D544,459 S *	6/2007	Wang	D14/138
D546,313 S *	7/2007	Lheem	D14/138
D557,244 S *	12/2007	Lee et al.	D14/138
D558,717 S *	1/2008	Baik et al.	D14/138
D566,090 S *	4/2008	Moon	D14/138

D567,797 S *	4/2008	Suk et al.	D14/138
D568,827 S *	5/2008	Ikeda et al.	D13/168
2004/0242288 A1 *	12/2004	Balle et al.	455/575.1
2006/0234786 A1 *	10/2006	Taniguchi et al.	455/575.4
2006/0287015 A1 *	12/2006	Dunko	455/575.4
2007/0293283 A1 *	12/2007	Inubushi et al.	455/575.1

OTHER PUBLICATIONS

Gigabyte g-YoYo, announced 2006, [online], [retrieved on Feb. 20, 2007]. Retrieved from Internet ,<URL: <http://www.gsmarena.com>>.*

Gigabyte g-Smart t600, announced Feb. 2007, [online], [retrieved on Mar. 12, 2007]. Retrieved from Internet ,<URL: <http://www.gsmarena.com>>.*

Motorola A920, announced 2003, [online], [retrieved on Feb. 16, 2007]. Retrieved from Internet ,<URL: <http://www.gsmarena.com>>.*

Sony Ericsson S700, announced Mar. 2004, [online], [retrieved on Feb. 16, 2007]. Retrieved from Internet ,<URL: <http://www.gsmarena.com>>.*

Sony Ericsson W580, announced Mar. 2007, [online], [retrieved on Apr. 3, 2007]. Retrieved from Internet ,<URL: <http://www.gsmarena.com>>.*

* cited by examiner

Primary Examiner—Jeffrey D. Asch

Assistant Examiner—Bridget L Eland

(74) *Attorney, Agent, or Firm*—Staas & Halsey LLP

(57) **CLAIM**

The ornamental design for a mobile phone, as shown and described.

DESCRIPTION

FIG. 1 is a perspective view of a mobile phone;
FIG. 2 is a front view of the mobile phone of FIG. 1;
FIG. 3 is a rear view of the mobile phone of FIG. 1;
FIG. 4 is left-side of the mobile phone of FIG. 1;
FIG. 5 is right-side of the mobile phone of FIG. 1;
FIG. 6 is top plan view of the mobile phone of FIG. 1;
FIG. 7 is bottom plan view of the mobile phone of FIG. 1; and,
FIG. 8 is an open perspective view of the mobile phone.

1 Claim, 6 Drawing Sheets

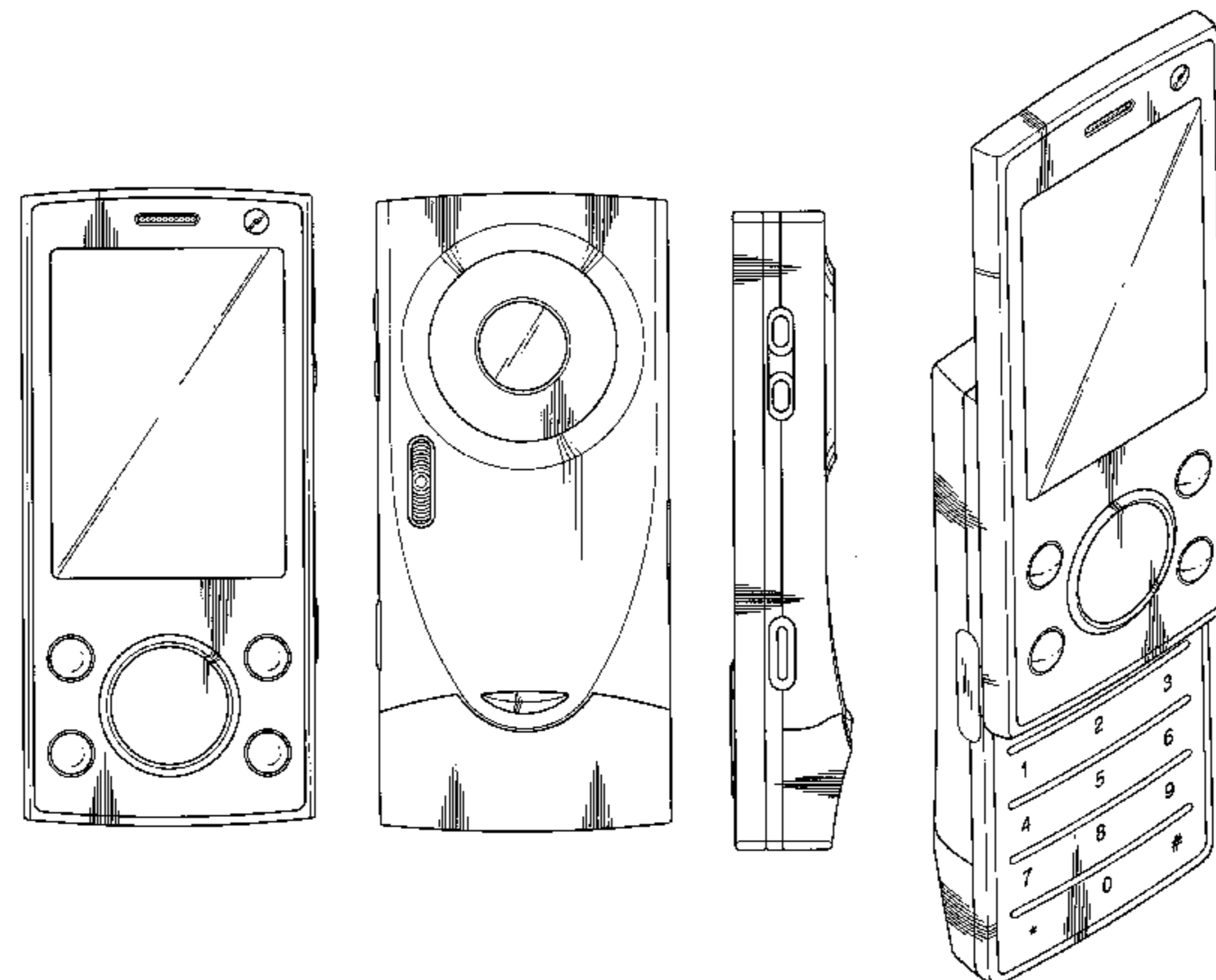

FIG. 1

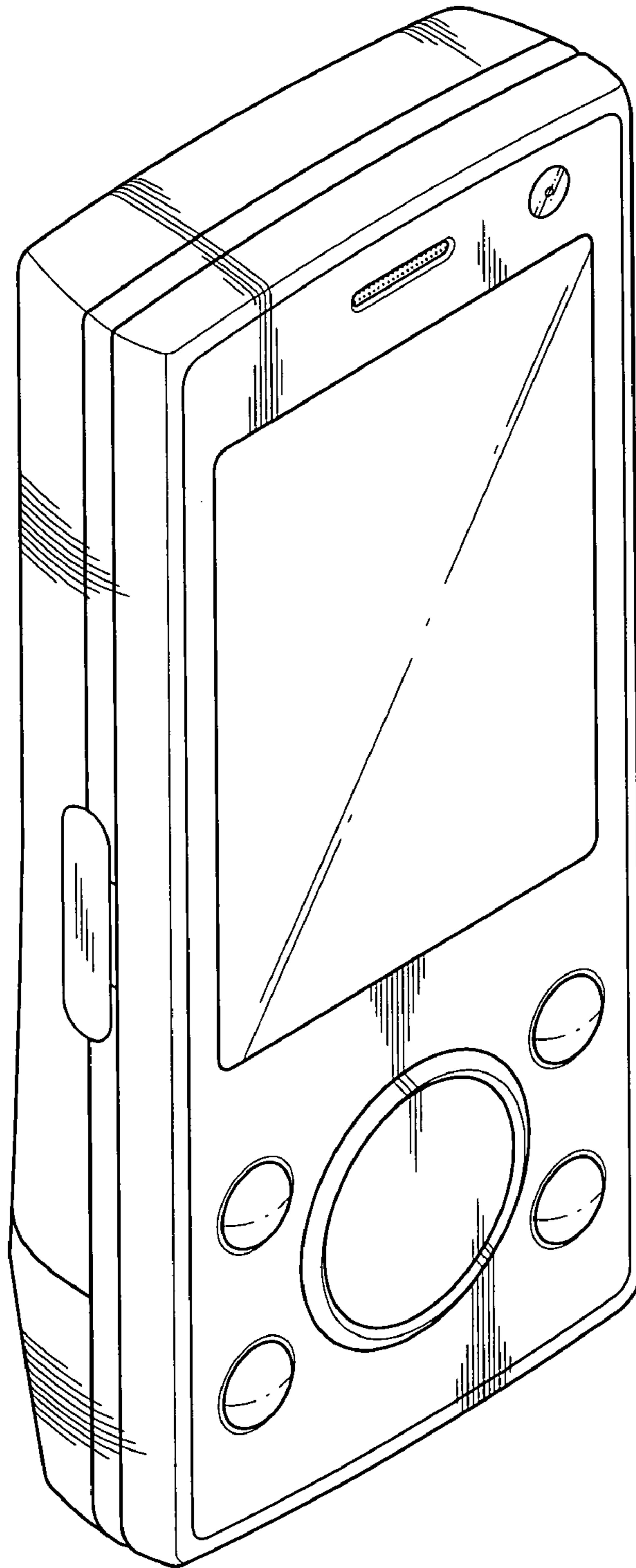

FIG. 2

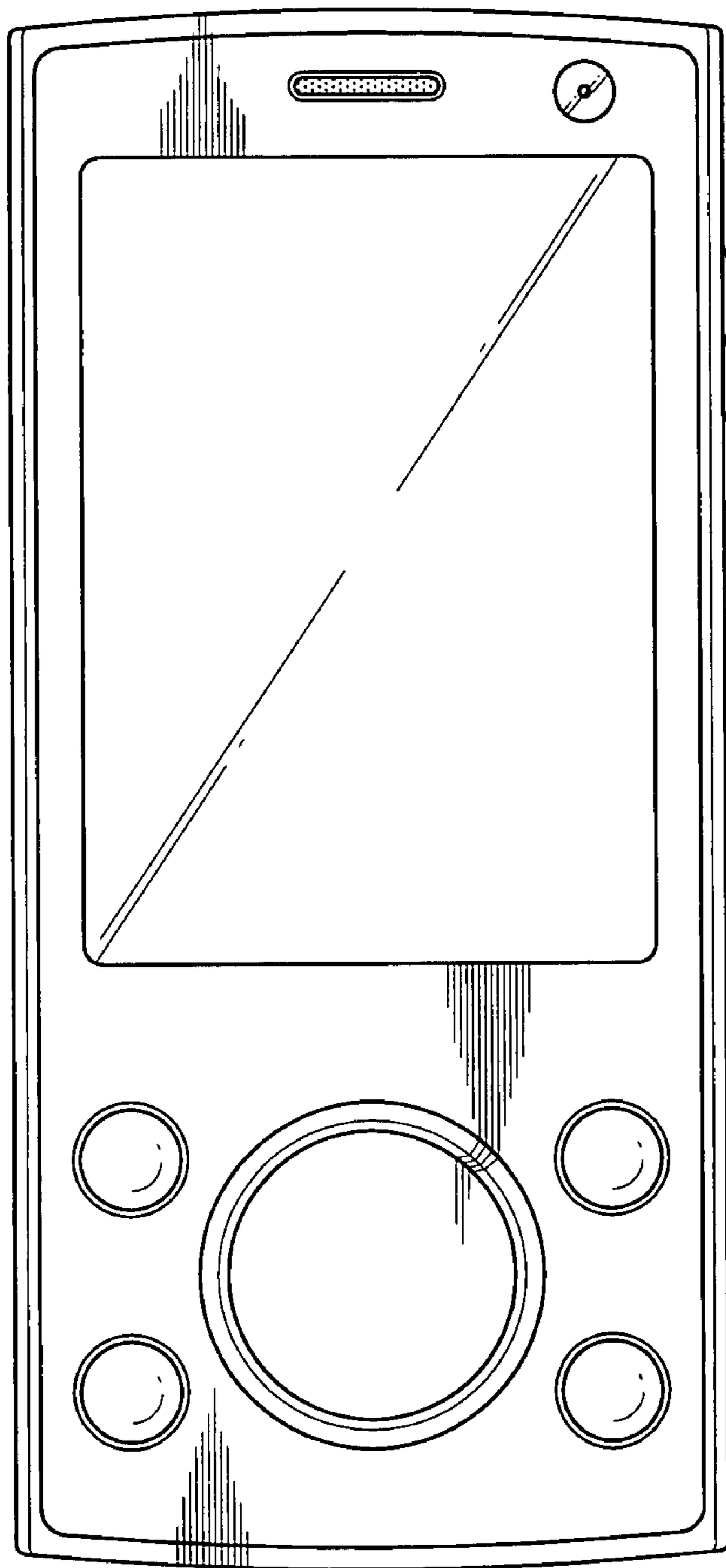

FIG. 3

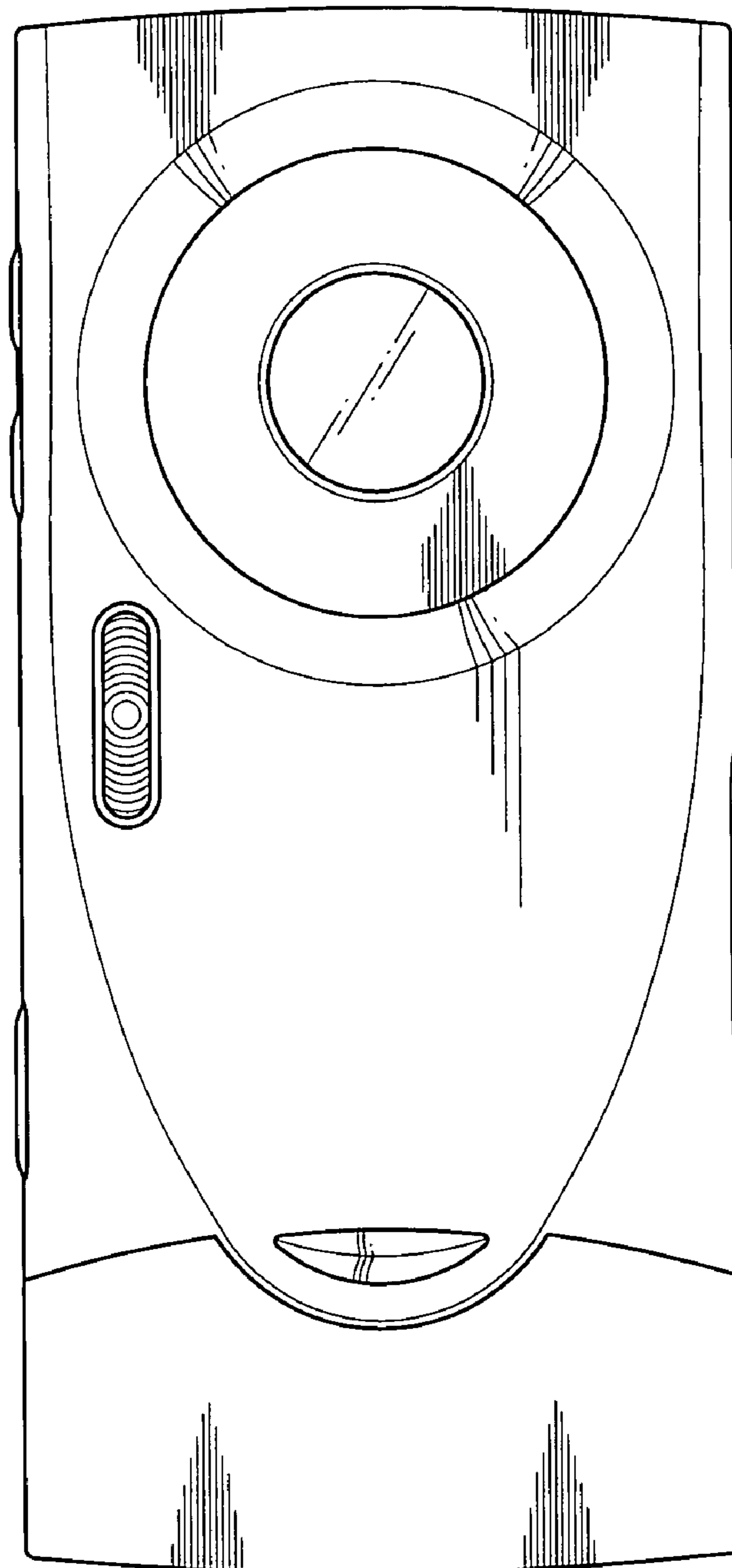

FIG. 4

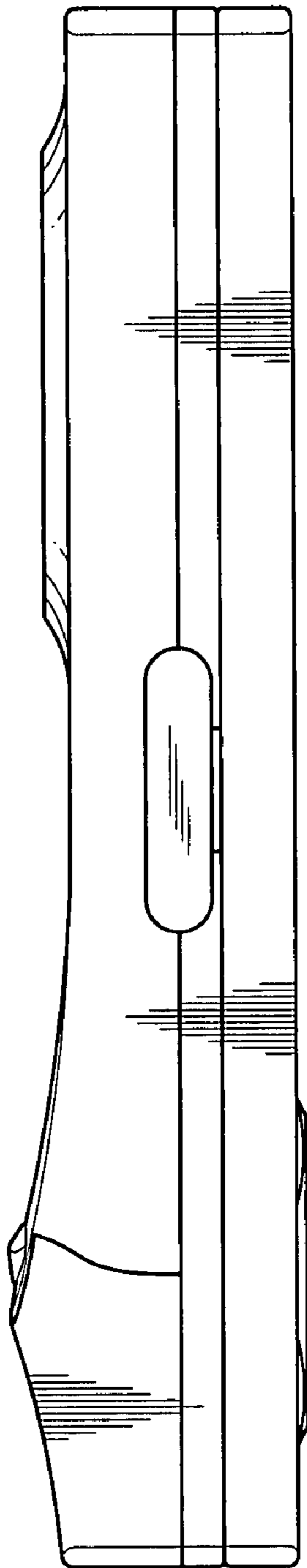

FIG. 5

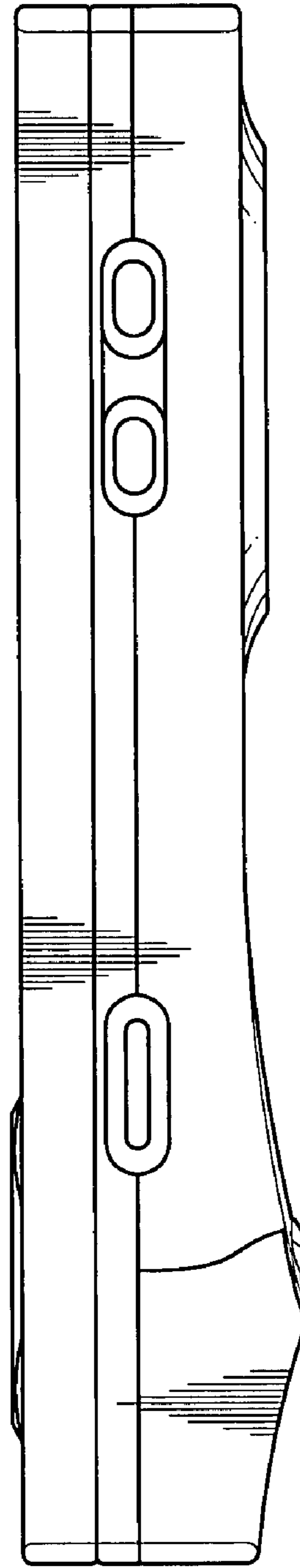

FIG. 6

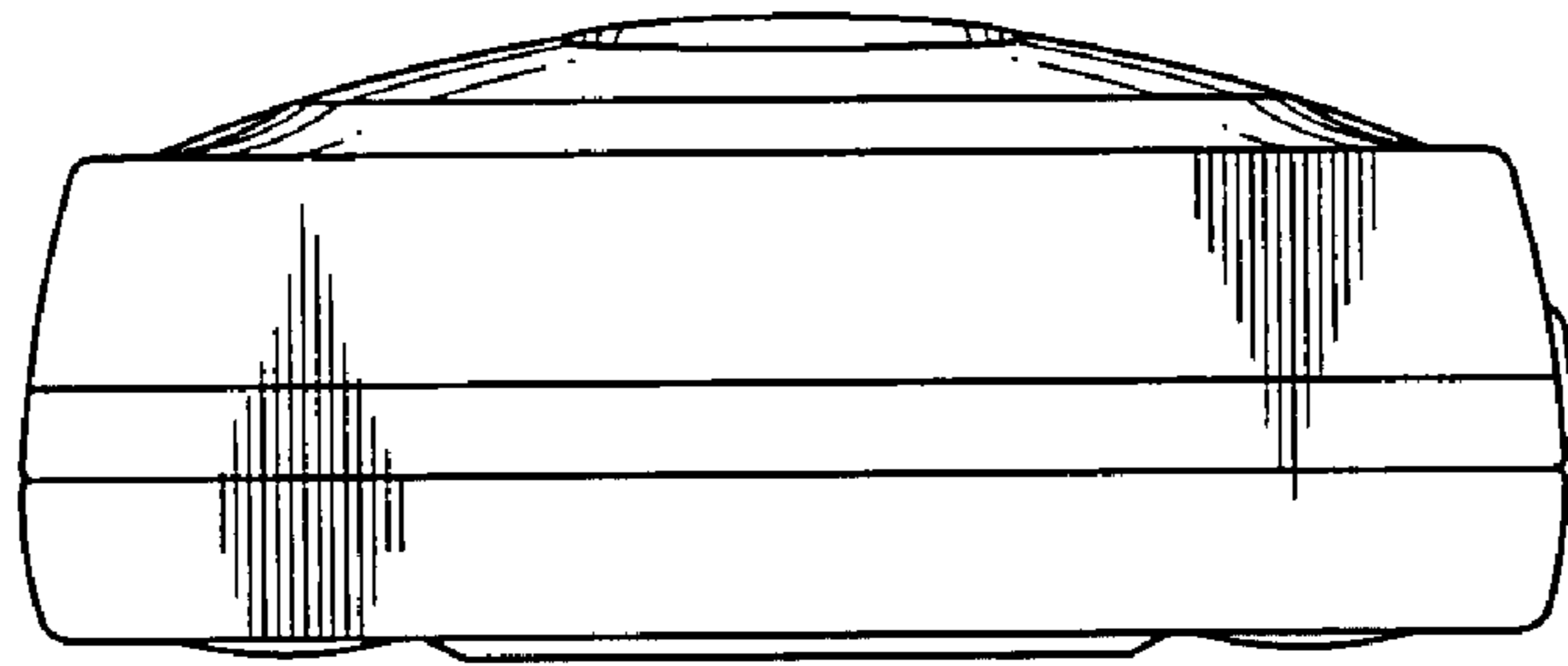

FIG. 7

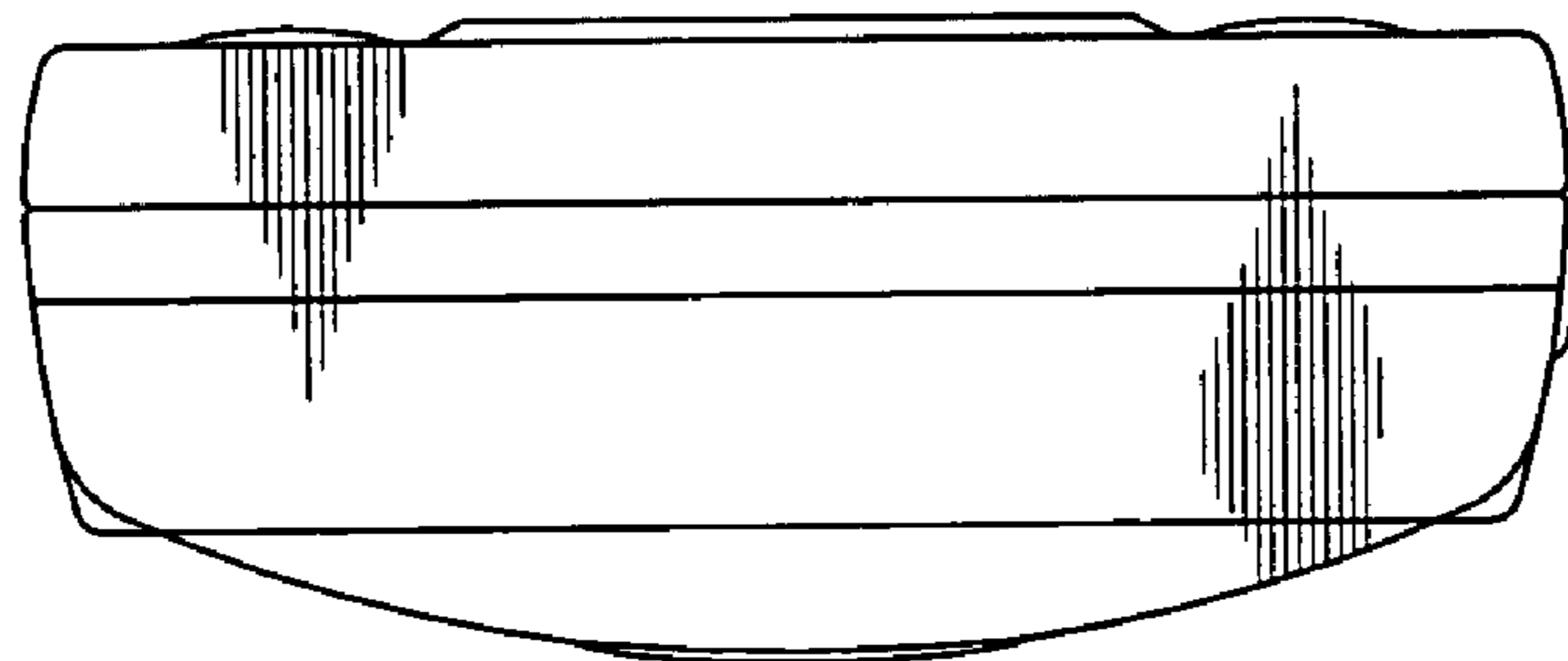

FIG. 8

