

US00D579434S

(12) **United States Design Patent**  
**Park et al.**

(10) **Patent No.:** **US D579,434 S**  
(45) **Date of Patent:** **\*\* Oct. 28, 2008**

(54) **MOBILE PHONE**

(75) Inventors: **Hyoung-Shin Park**, Seoul (KR);  
**Sang-Min Hyun**, Seoul (KR);  
**Chang-Hwan Hwang**, Goyang-si (KR)

(73) Assignee: **Samsung Electronics Co., Ltd.**,  
Suwon-Si (KR)

(\*\*) Term: **14 Years**

(21) Appl. No.: **29/290,234**

(22) Filed: **Nov. 7, 2007**

(30) **Foreign Application Priority Data**

Aug. 2, 2007 (KR) ..... 30-2007-0033373

(51) **LOC (8) Cl.** ..... **14-03**

(52) **U.S. Cl.** ..... **D14/138**

(58) **Field of Classification Search** ..... D14/137,  
D14/138, 147, 191, 218, 247-248, 341-347,  
D14/496; D10/65, 78, 104; D13/7; 455/556.1,  
455/566, 575.1, 575.3; 345/169

See application file for complete search history.

(56) **References Cited**

**U.S. PATENT DOCUMENTS**

D495,695 S	*	9/2004	Yugaya	.....	D14/346
D496,645 S	*	9/2004	Yoo et al.	.....	D14/138
D503,642 S	*	4/2005	Hutchison et al.	.....	D10/81
D525,609 S	*	7/2006	Kim et al.	.....	D14/138
D528,094 S	*	9/2006	Hwang	.....	D14/138
D530,297 S	*	10/2006	Moon et al.	.....	D14/138
D534,516 S	*	1/2007	Lheem	.....	D14/138
D536,691 S	*	2/2007	Park	.....	D14/138
D545,843 S	*	7/2007	Song	.....	D14/496
D549,205 S	*	8/2007	Cho	.....	D14/138
D550,189 S	*	9/2007	Kim et al.	.....	D14/138
D552,579 S	*	10/2007	Lee et al.	.....	D14/138
D558,713 S	*	1/2008	Kim et al.	.....	D14/138
D558,789 S	*	1/2008	Yu et al.	.....	D14/496
D559,220 S	*	1/2008	Lee et al.	.....	D14/138
D560,192 S	*	1/2008	Lee et al.	.....	D14/138
D561,148 S	*	2/2008	Chen	.....	D14/138
D563,929 S	*	3/2008	Park	.....	D14/138
D563,938 S	*	3/2008	Kim et al.	.....	D14/138
D569,830 S	*	5/2008	Kwak	.....	D14/138

2001/0018340	A1*	8/2001	Tagi	.....	455/414
2007/0049358	A1*	3/2007	Kang et al.	.....	455/575.1
2007/0232370	A1*	10/2007	Kim	.....	455/575.4
2007/0242048	A1*	10/2007	Yang	.....	345/169
2007/0293285	A1*	12/2007	Kang et al.	.....	455/575.1
2008/0004085	A1*	1/2008	Jung et al.	.....	455/566

**OTHER PUBLICATIONS**

Asus J501, announced Feb. 2007, [online], [retrieved on Sep. 15, 2007]. Retrieved from Internet ,<URL: <http://www.gsmarena.com>>.\*

BenQ EL71, announced Feb. 2006, [online], [retrieved on Dec. 13, 2007]. Retrieved from Internet ,<URL: <http://www.gsmarena.com>>.\*

LG KF600, announced Feb. 2008, [online], [retrieved on Mar. 21, 2008]. Retrieved from Internet ,<URL: <http://www.gsmarena.com>>.\*

Samsung G800, announced Oct. 2007, [online], [retrieved on Dec. 13, 2007]. Retrieved from Internet ,<URL: <http://www.gsmarena.com>>.\*

\* cited by examiner

*Primary Examiner*—Jeffrey D. Asch

*Assistant Examiner*—Bridget L Eland

(74) *Attorney, Agent, or Firm*—Staas & Halsey LLP

(57) **CLAIM**

The ornamental design for a mobile phone, as shown and described.

**DESCRIPTION**

FIG. 1 is a perspective view of a mobile phone;  
FIG. 2 is a front view of the mobile phone of FIG. 1;  
FIG. 3 is a rear view of the mobile phone of FIG. 1;  
FIG. 4 is left-side of the mobile phone of FIG. 1;  
FIG. 5 is right-side of the mobile phone of FIG. 1;  
FIG. 6 is top plan view of the mobile phone of FIG. 1;  
FIG. 7 is bottom plan view of the mobile phone of FIG. 1; and,  
FIG. 8 is an open perspective view of the mobile phone of FIG. 1, where the display portion slid horizontally.

**1 Claim, 6 Drawing Sheets**

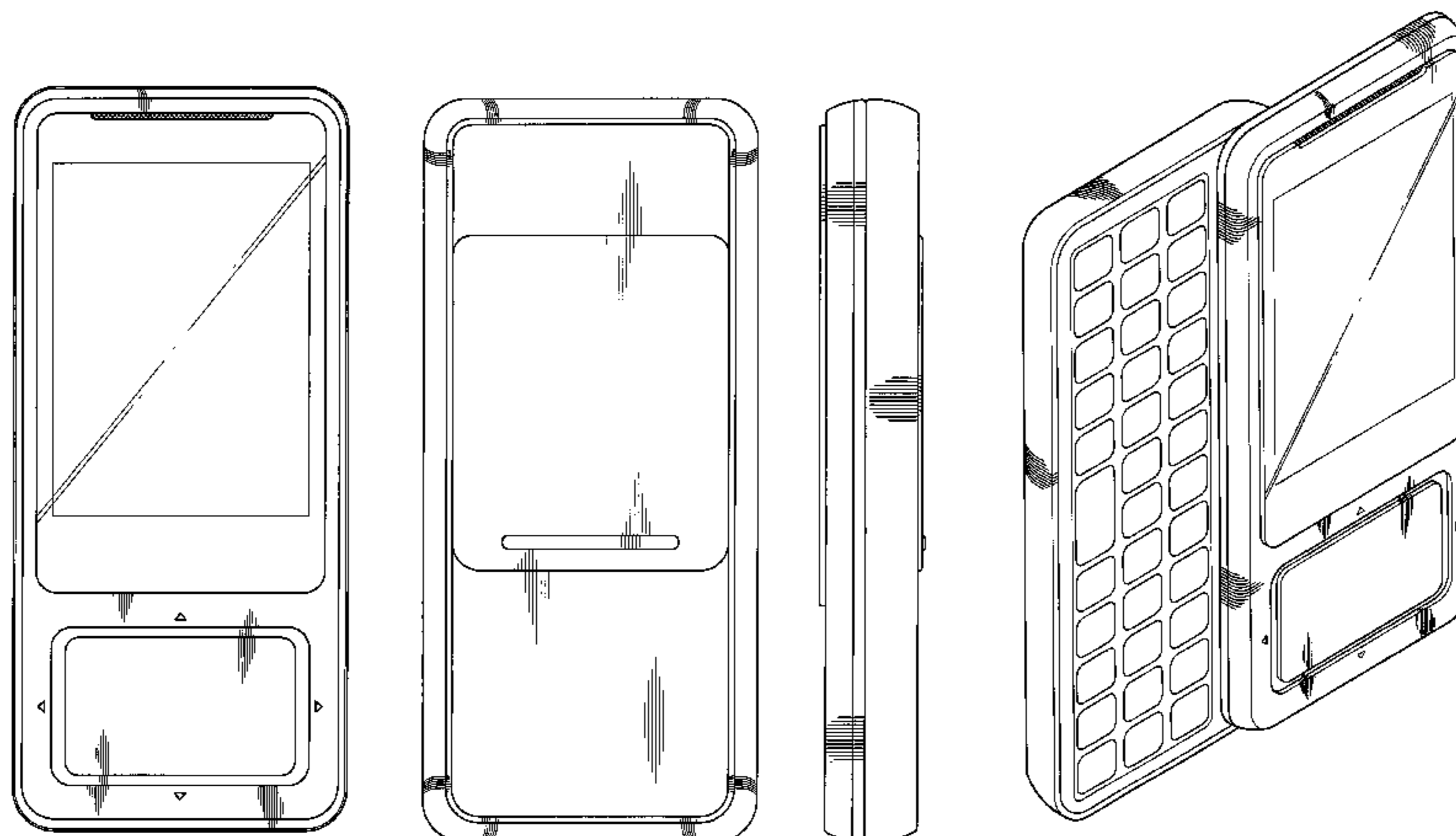

FIG. 1

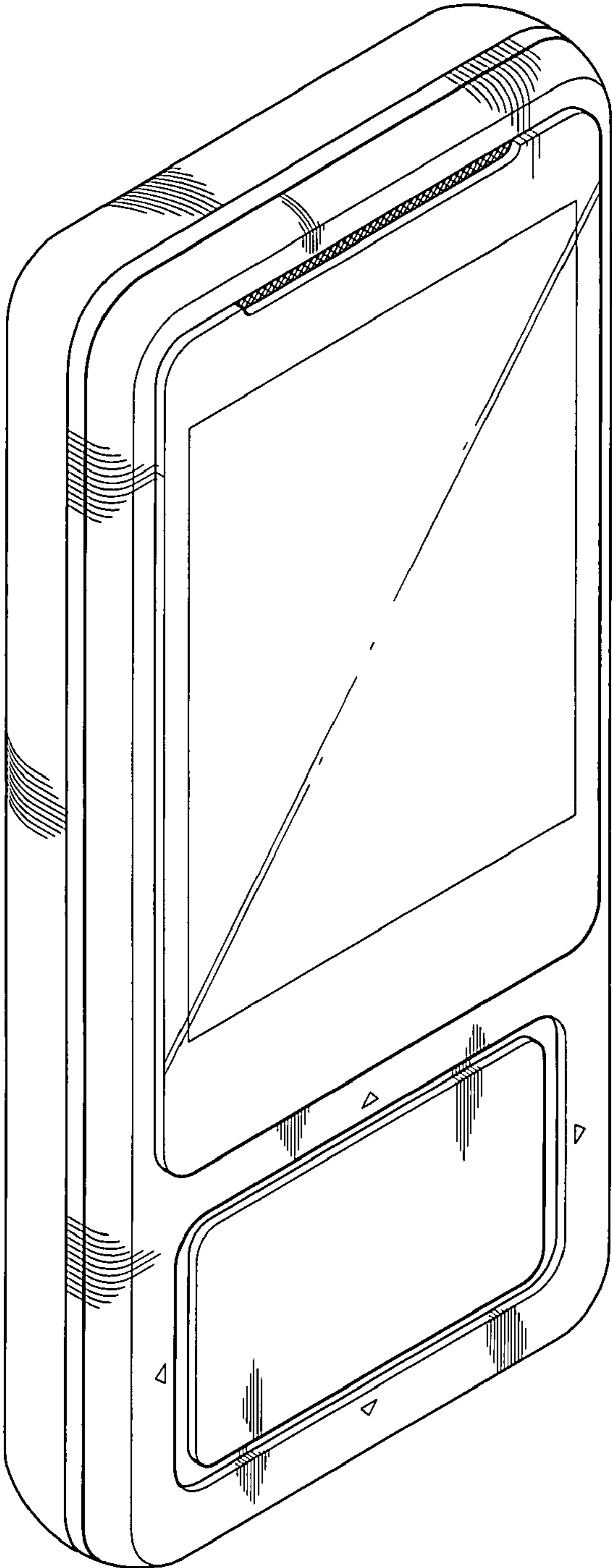

FIG. 2

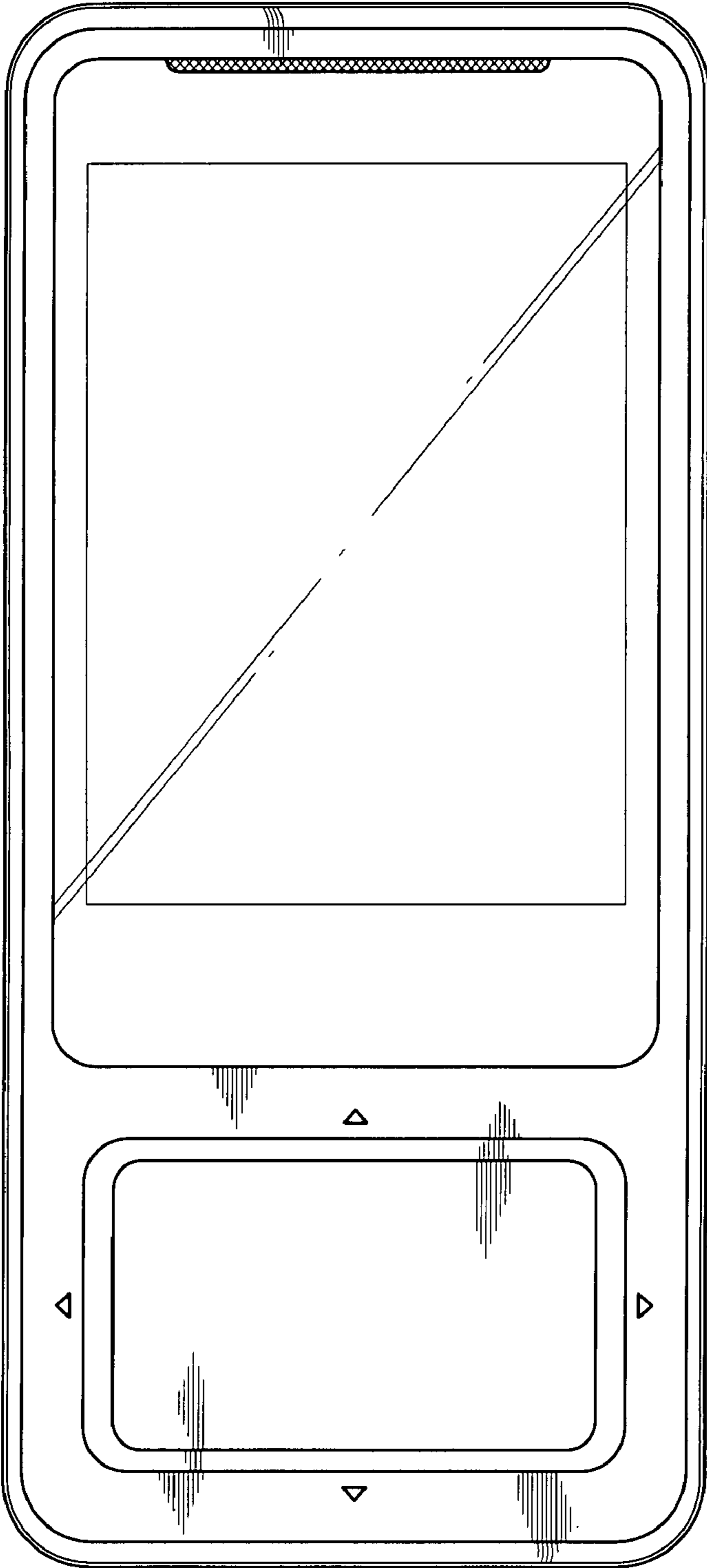

FIG. 3

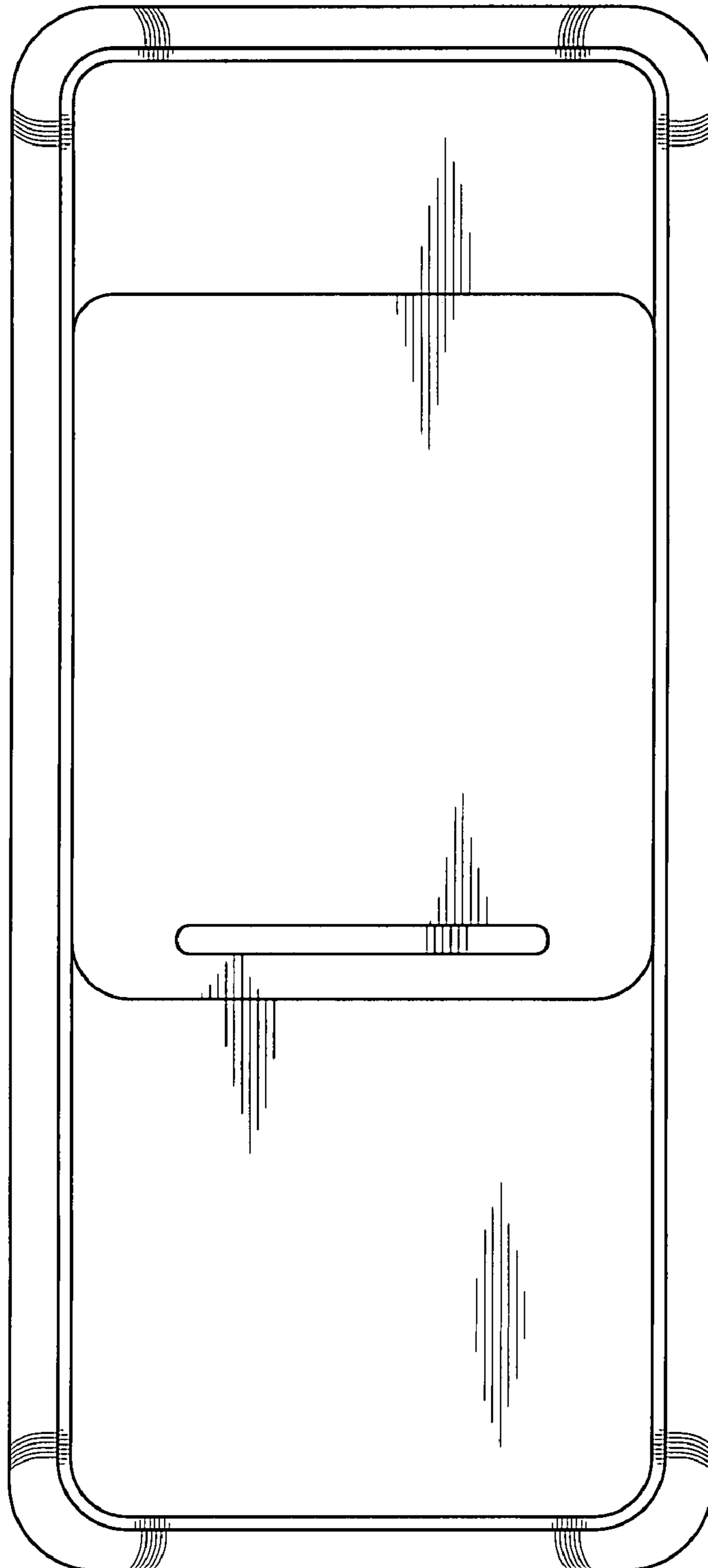

FIG. 4

FIG. 5

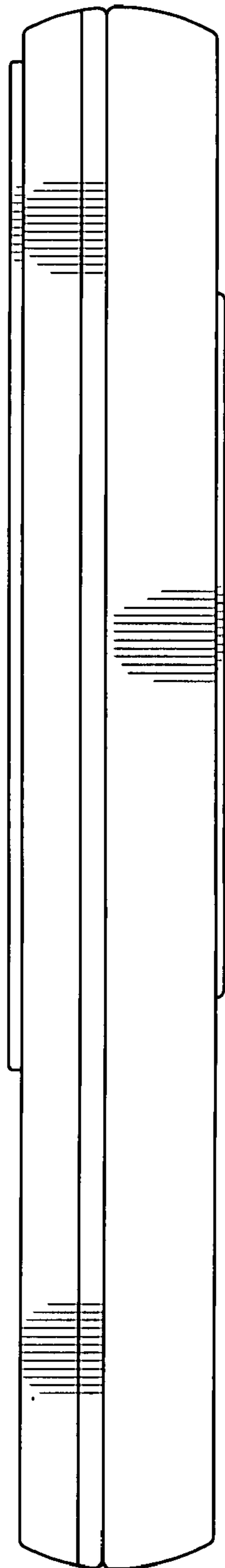
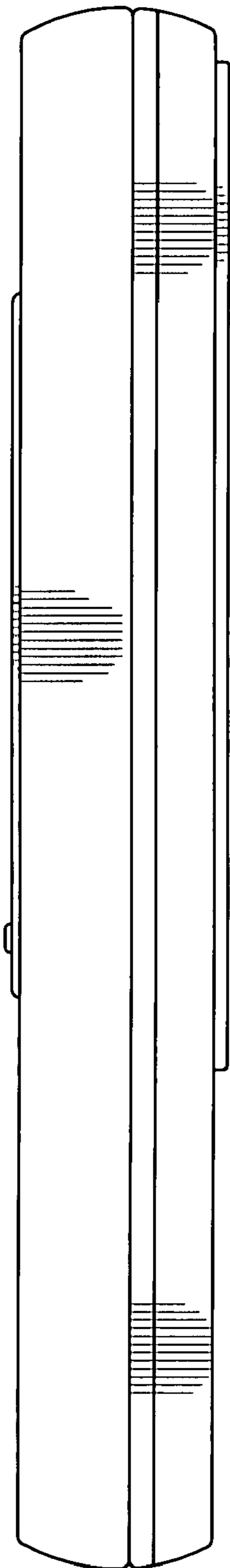

FIG. 6

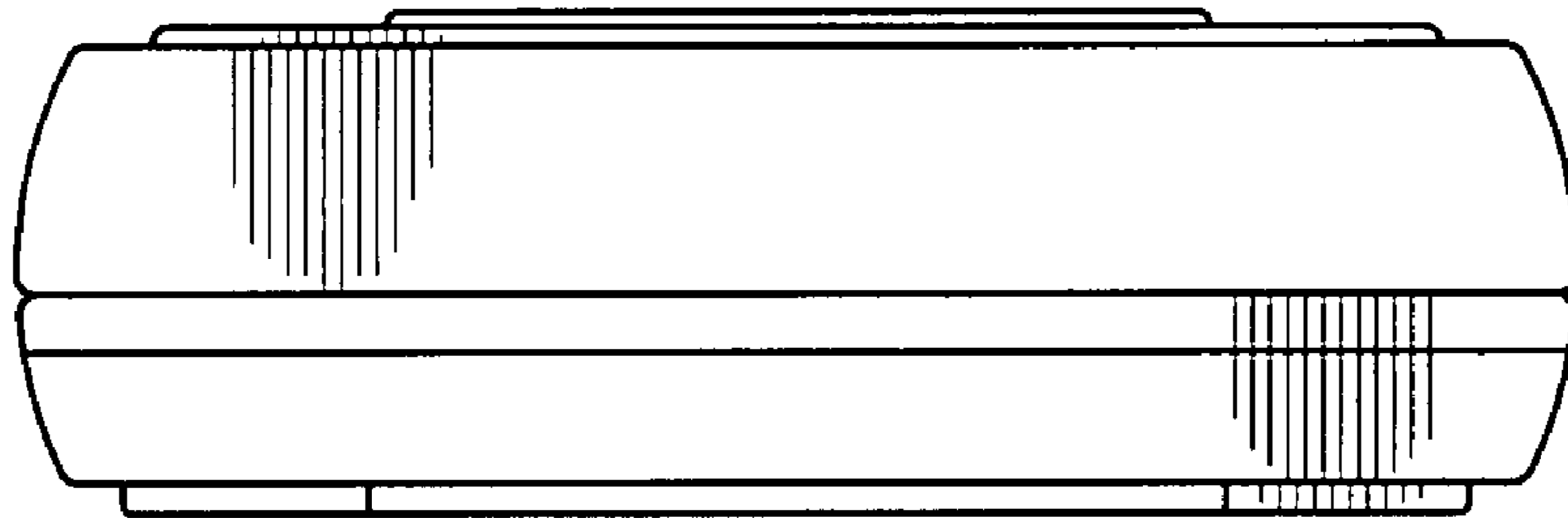

FIG. 7

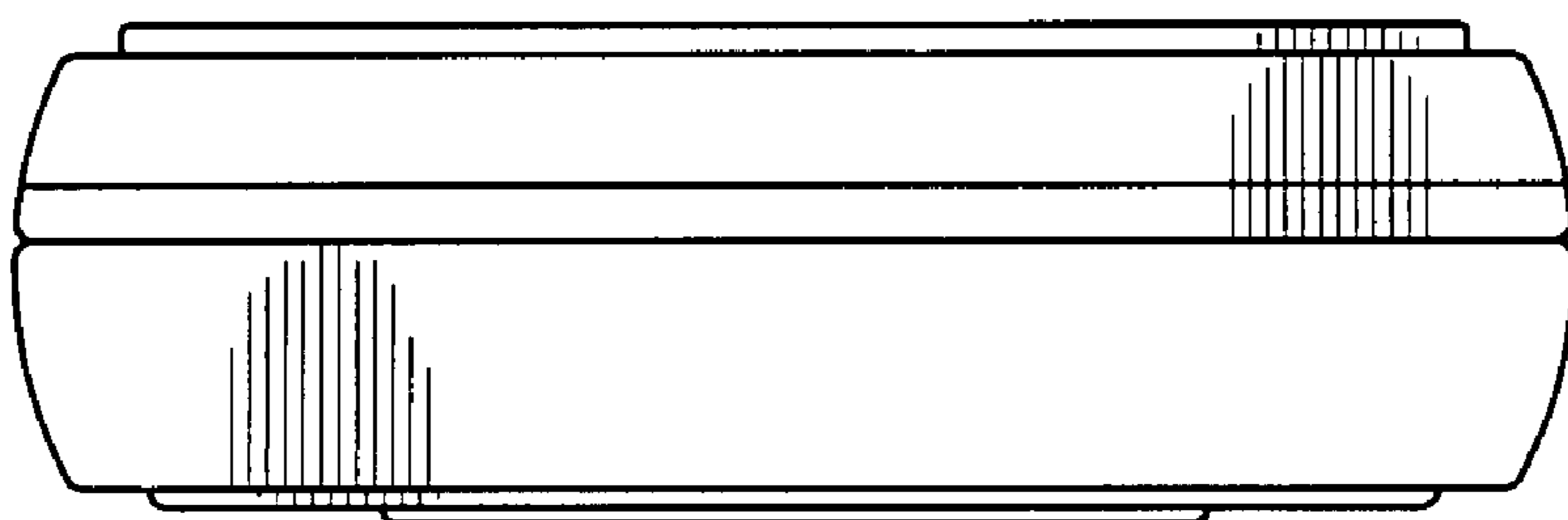



FIG. 8

